

Click [here](#) for production status of specific part numbers.

MAX77504 FC2QFN Evaluation Kit

Evaluates: MAX77504
(MAX77504AAFC+)

General Description

The MAX77504 evaluation kit (EV kit) provides a proven design to evaluate the MAX77504, a 3A high-efficiency buck converter. The IC is capable of 2.6V to 14V input and is output voltage configurable between 0.6V to 6V. The factory default output voltage of this EV kit is set at 3.3V. Output voltage can be configured by changing the feedback resistor values (R3 and R4). Two GPIO pins are available to support Force PWM/SYNC and EN function.

Ordering Information appears at end of data sheet.

Features and Default Settings

- Sense Points for High-Accuracy Measurements
- Accessible Test Points for EN, POK, FPWM, and OUTS
- Switching Frequency Configurable Between 500kHz to 1.5MHz Through SEL
- Externally Synchronized FPWM Mode Capability
- FPWM and Skip Mode Configurable (Skip Mode Default)
- UVLO Rising = 2.6V, UVLO Falling = 2.4V

SPECIFICATION	TEST CONDITIONS	MIN	TYP	MAX	UNIT
Input Voltage		2.6		14	V
Output Voltage		0.6		6	V
Default Output Voltage	R3 = 49.9kΩ, R4 = 11.1kΩ		3.3		V
Output Current		0		3	A
Peak Efficiency	3.7V _{IN} , 3.3V _{OUT} , 300mA load			97.6	%

MAX77504 Evaluation Board

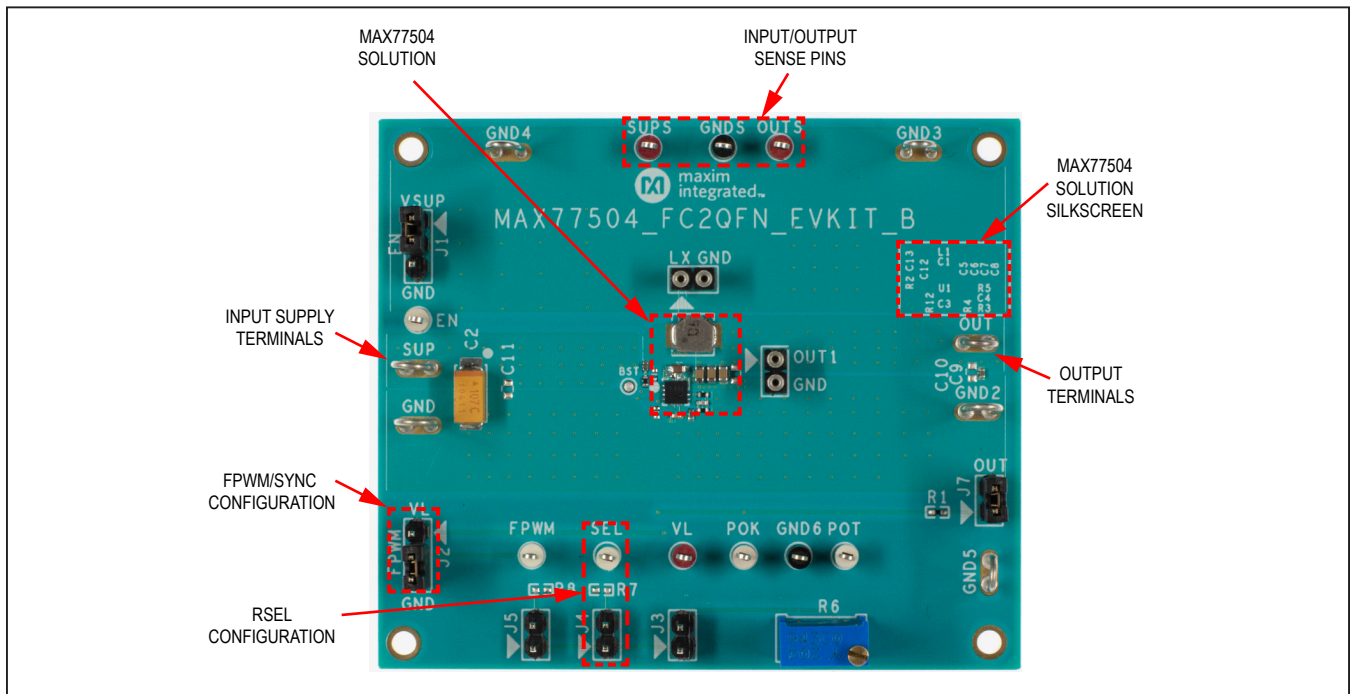

Quick Start

Required Equipment

- MAX77504 EV kit
- Adjustable DC power supply with 14V and 3A capability
- Digital Multimeters

Procedure

The EV kit is fully assembled and tested. Follow the steps below to verify board operation. Use twisted wires of appropriate gauge (20AWG) that are as short as possible to connect the load and power sources.

- 1) Ensure that the EV kit has the correct jumper settings, as shown in [Table 1](#).
- 2) Connect a DVM to the SUPS and GNDS sense pins to measure input voltage.
- 3) Connect a DVM to the OUTS and GNDS sense pins to measure output voltage.
- 4) Apply a power supply set to 0V (100mA current limit) across the VIN and PGND terminals of the EV kit. Turn the supply on and increase the voltage to 12V.
- 5) Confirm the DVM connected to OUTS and GNDS reads the default output voltage of the EV kit (3.3V).

Description of Hardware

The MAX77504 EV kit demonstrates the MAX77504 buck converter. It regulates output from input voltage ranges from 2.6V to 14V. Configurable output range is from 0.6V to 6.0V with feedback resistors R3 and R4. The EV kit is suited with a general DC input. [Table 1](#) lists jumpers and associated functions that are available on the EV kit.

Design Procedure (Choosing RSEL)

The MAX77504 includes an RSEL pin to configure the switching frequency, mid-band gain, and active discharge on startup. The configuration selection resistor (RSEL) sets five bits of configuration options decoded in [Table 2](#). Choose RSEL[4:0] carefully by following the procedure outlined in the *Design Procedure* section of the IC data sheet; or refer to the *Typical Application Circuits* section of the IC data sheet for a list of known good RSEL choices for common applications. Resistors with tolerance 1% (or better) should be chosen for R7, with nominal values specified in [Table 3](#). Ensure proper resistor configuration by measuring the resistance across SEL and GND sense points.

Table 1. Default Shunt Positions and Jumper Descriptions

JUMPER	NODE OR FUNCTION	SHUNT POSITION	FUNCTION
J1	EN	1-2*	Connects EN to V _{IN} (MAX77504 is enabled by default).
		2-3	Connects EN to GND.
J2	FPWM/SYNC	1-2	Enables FPWM function.
		2-3*	Enables SKIP mode function.
J3	RSEL	1-2	Potentiometer (R6) value configuration to set switching frequency, mid-band gain, and active discharge (Default RSEL = OPEN).
J4	RSEL	1-2	Resistor (R7) value configuration to set switching frequency, mid-band gain, and active discharge (Default RSEL = OPEN).
J5	RSEL	1-2	Resistor (R8) value configuration to set switching frequency, mid-band gain, and active discharge (Default RSEL = OPEN).
J7	POK	1-2*	Enables Power-OK indicator function.

* Default position

For example, choose a 30.9kΩ (1% TOL) resistor to program RSEL[4:0] to 0x16. 0x16 (0b10110) decodes with the following configuration:

- FSW[1:0] = 0b10 (1MHz switching frequency)
- GAIN[1:0] = 0b11 (200kΩ R_{COMP})
- ADEN = 0b0 (active discharge disabled)

Table 3 indicates that a 30.9kΩ selection resistor selects code 0b10110 (0x16). The device evaluates R_{SEL} whenever SUP is valid and EN transitions from logic 0 to 1. The decoded value of R_{SEL} is latched until the next EN rising edge.

Table 2. MAX77504 RSEL Configuration Bits

RSEL[4:0]		NAME	DESCRIPTION	DECODE
MSB	Bit 4	FSW[1:0]	Switching Frequency Control. Sets F _{SW} .	00 = 0.5MHz 01 = 0.75MHz 10 = 1.0MHz 11 = 1.5MHz
	Bit 3			
	Bit 2	GAIN[1:0]	Mid-band gain control. Sets R _{COMP} .	00 = 75kΩ 01 = 100kΩ 10 = 150kΩ 11 = 200kΩ
	Bit 1			
LSB	Bit 0	ADEN	Active discharge resistor enable.	0 = disabled 1 = enabled

Program these bits by choosing a configuration selection resistor (R_{SEL}) with a tolerance of 1% or better using lookup Table 3.

Table 3. Configuration Selection Resistor (RSEL) Lookup Table

R _{SEL} (Ω) → RSEL[4:0]		
95.3Ω or SHORT → 0x00	1620Ω → 0x0B	30900Ω → 0x16
200Ω → 0x01	1870Ω → 0x0C	36500Ω → 0x17
309Ω → 0x02	2150Ω → 0x0D	42200Ω → 0x18
422Ω → 0x03	2490Ω → 0x0E	48700Ω → 0x19
536Ω → 0x04	2870Ω → 0x0F	56200Ω → 0x1A
649Ω → 0x05	3740Ω → 0x10	64900Ω → 0x1B
768Ω → 0x06	8060Ω → 0x11	75000Ω → 0x1C
909Ω → 0x07	12400Ω → 0x12	86600Ω → 0x1D
1050Ω → 0x08	16900Ω → 0x13	100000Ω → 0x1E
1210Ω → 0x09	21500Ω → 0x14	115000Ω or OPEN → 0x1F
1400Ω → 0x0A	26100Ω → 0x15	

External Clock Synchronization (SYNC)

To enable the externally synchronized forced-PWM (FPWM) mode, provide an external clock signal to FPWM/SYNC with a frequency inside the valid range ($f_{SYNC-VALID}$), as shown in [Figure 1](#) (Pin 2 of J2 or FPWM sense pin). The valid lockable range shifts depending on the chosen

internal switching frequency (FSW[1:0] programmed by RSEL). Refer to the FPWM/SYNC section of the *Electrical Characteristics* table in the IC data sheet for the guaranteed valid lock ranges versus the FSW[1:0] choice. Refer to the *External Clock Synchronization (SYNC)* section of the IC data sheet for more information.

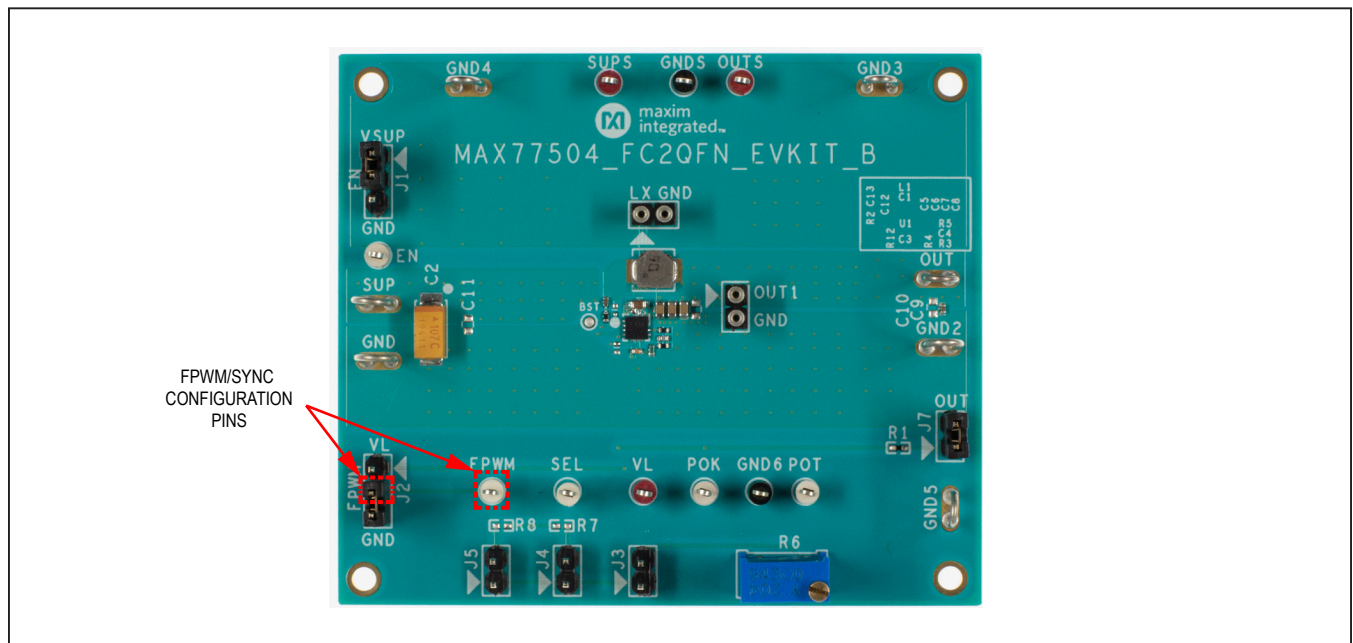

Figure 1. FPWM/SYNC Pin

Ordering Information

PART	U1 IC	DEFAULT OUTPUT VOLTAGE	UVLO FALLING	UVLO RISING
MAX77504QEVKIT#	MAX77504AAFC+	3.3V	2.4V	2.6V

MAX77504 EV Kit Bill of Materials

PART	QTY	MFG PART #	MANUFACTURER	DESCRIPTION
C1	1	C1608X5R1E106M080AC	TDK	10 μ F \pm 10%, 10V X5R CERAMIC CAPACITOR (0603)
C3	1	ANY	ANY	2.2 μ F \pm 10%, 6.3V X5R CERAMIC CAPACITOR (0402)
C4	1	GRM1555C1H2R2BA01	MURATA	2.2pF \pm 5%, 50V COG CERAMIC CAPACITOR (0402)
C5, C6, C7	3	C1608X5R1A226M080AC	TDK	22 μ F \pm 20%, 10V X5R CERAMIC CAPACITOR (0603)
C13	1	ANY	ANY	0.22 μ F \pm 10%, 16V X7R CERAMIC CAPACITOR (0402)
J1, J2	2	TSW-103-07-T-S	SAMTEC	STRAIGHT CONNECTOR, 3 PINS
J7	1	TSW-102-07-T-S	SAMTEC	STRAIGHT CONNECTOR, 2 PINS
L1	1	FDSD0412-H-1R5M	MURATA	1.5 μ H \pm 20%, ISAT=5.5A, DCR=53m Ω
R2, R5	1	ANY	ANY	0 Ω , RESISTOR (0402)
R3	1	ERJ-2RKF4992	PANASONIC	49.9k Ω , RESISTOR (0402)
R4	1	TNPW040211K1BE	VISHAY	11.1k Ω , RESISTOR (0402)
U1	1	MAX77504AAFC+	MAXIM	BUCK (12 FC2QFN), MAX77504AAFC+
Components below this line are outside of the immediate MAX77504 evaluation circuit and solution silkscreen.				
C9	1	ANY	ANY	0.1 μ F \pm 10%, 10V X5R CERAMIC CAPACITOR (0402)
C11	1	TPSC107K016R0200	AVX	100 μ F \pm 10%, 16V TANTALUM CAPACITOR (6032)
EN, FPWM, POK, POT, SEL	5	5002	KEYSTONE	TEST POINT; PIN DIA=0.1IN; TOTAL LENGTH=0.3IN; BOARD HOLE=0.04IN; WHITE; PHOSPHOR BRONZE WIRE SILVER;
GND, GND2- GND5, OUT, SUP	4	9020 BUSS	WEICO WIRE	EVK KIT PARTS; MAXIM PAD; WIRE; NATURAL; SOLID; WEICO WIRE; SOFT DRAWN BUS TYPE-S; 20AWG
J3, J4, J5	3	TSW-102-07-T-S	SAMTEC	STRAIGHT CONNECTOR, 2 PINS
LX, OUT1	2	SS-102-TT-2	SAMTEC	IC-SOCKET; SIP; STRAIGHT; PRECISION MACHINED SOCKET STRIP; OPEN FRAME; 2PINS; 100MIL
OUTS, SUPS, VL	3	5000	KEYSTONE	TEST POINT; PIN DIA=0.1IN; TOTAL LENGTH=0.3IN; BOARD HOLE=0.04IN; RED; PHOSPHOR BRONZE WIRE SILVER PLATE FINISH;
R1	1	CRCW0402100KFK	VISHAY	100k Ω \pm 1%, RESISTOR (0402)
R6	1	3296Y-1-204LF	BOURNS	RESISTOR; THROUGH HOLE-RADIAL LEAD; 3296 SERIES; 200K OHM; 10%; 100PPM; 0.5W
PCB	1	MAX77504FC2QFN	MAXIM	PCB:MAX77504FC2QFN
C2, C8, C10	0	N/A	N/A	CAPACITOR; SMT (0603); OPEN; FORMFACTOR
C12	0	N/A	N/A	CAPACITOR; SMT (0402); OPEN; FORMFACTOR
R7, R8, R12	0	N/A	N/A	RESISTOR; 0402; OPEN; FORMFACTOR

MAX77504 EV Kit Schematic

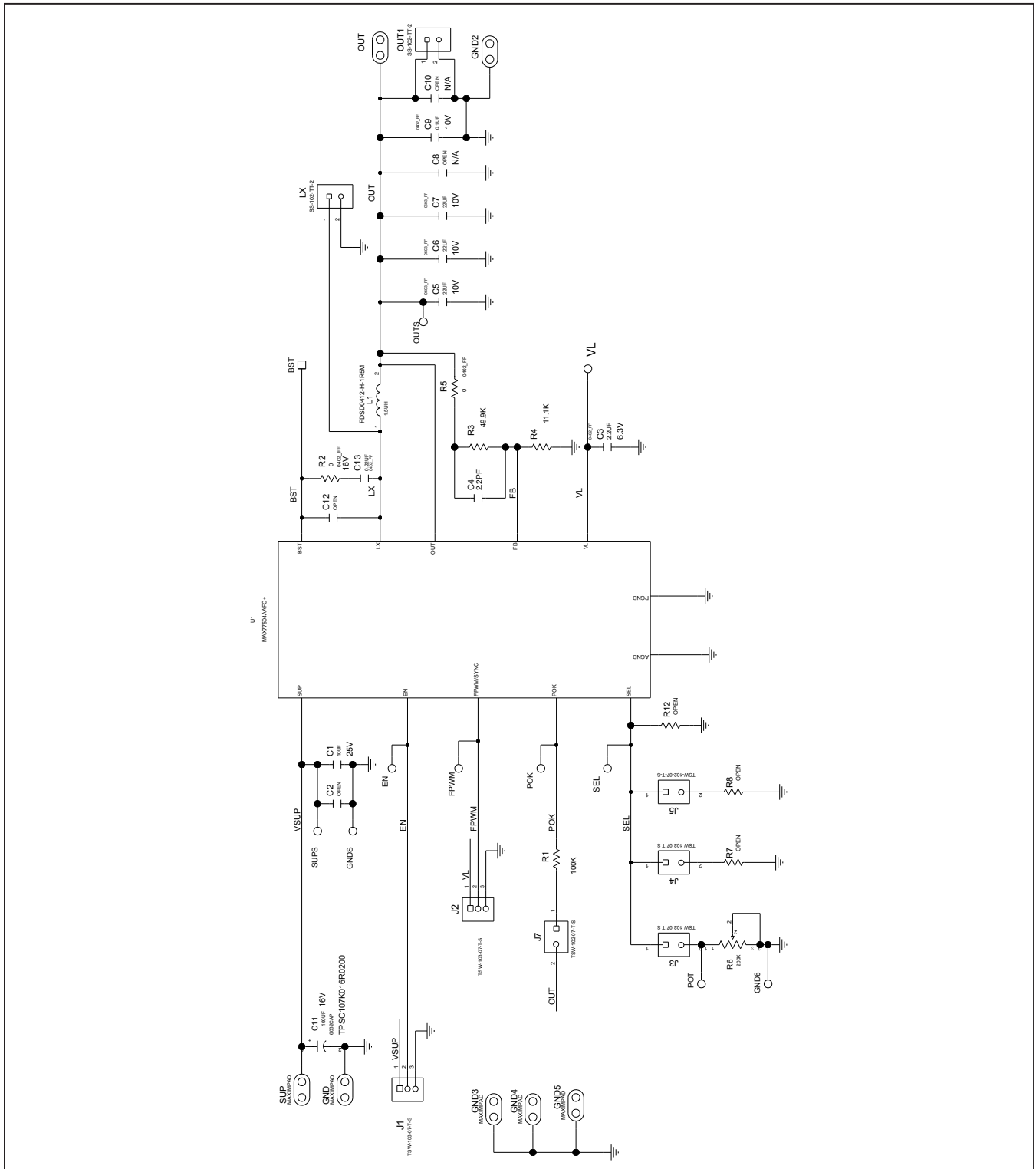

MAX77504 EV Kit PCB Layout Diagrams

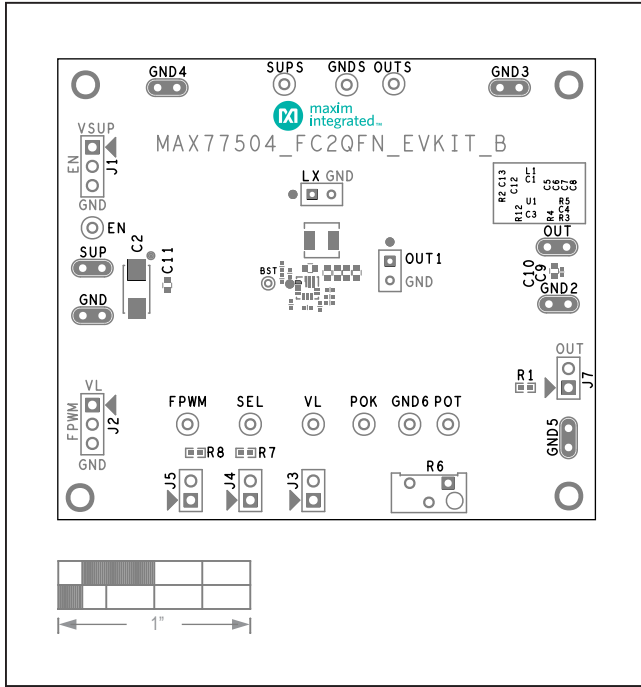

MAX77504 EV Kit Component Placement Guide—Top Silkscreen

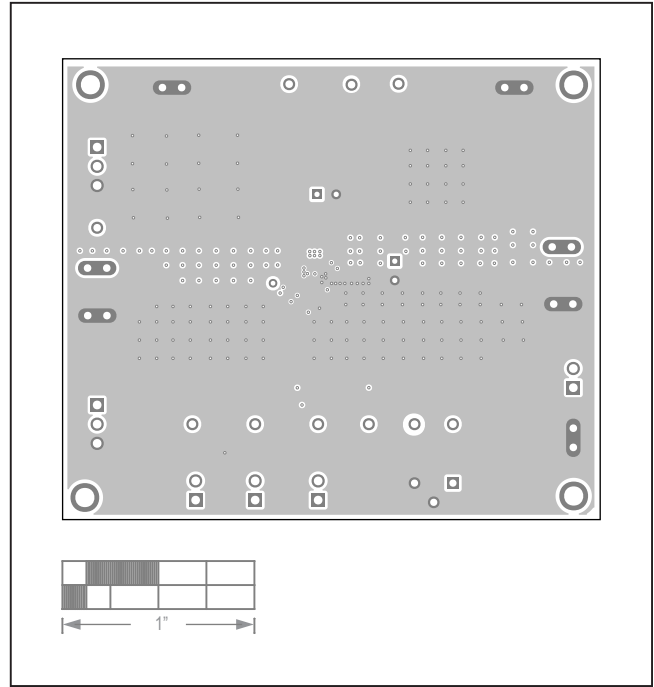

MAX77504 EV Kit PCB Layout—Internal 2

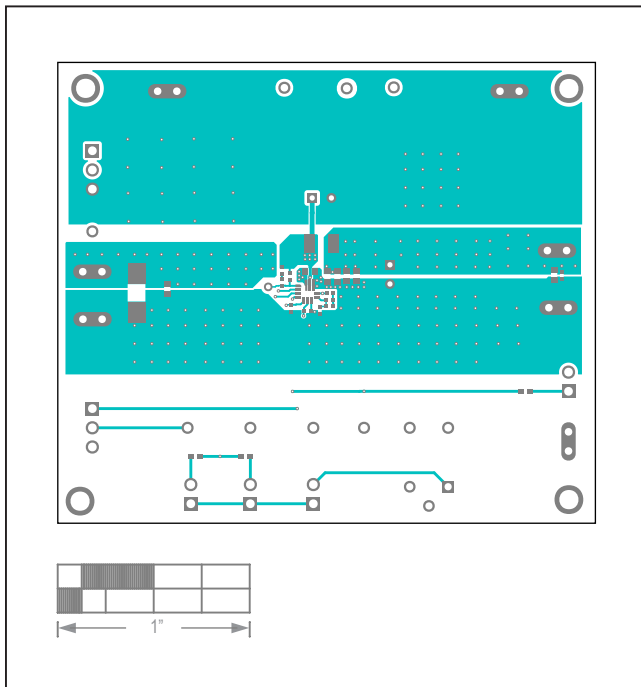

MAX77504 EV Kit PCB Layout—Top

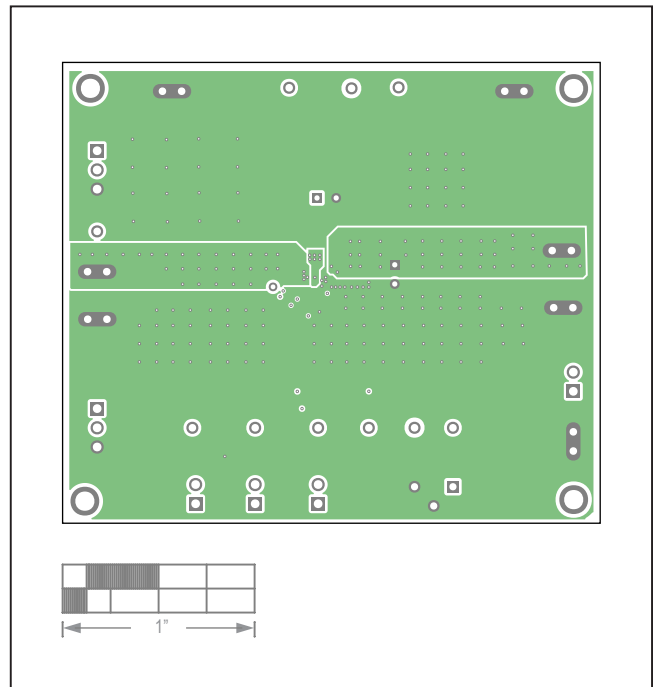

MAX77504 EV Kit PCB Layout—Internal 3

MAX77504 EV Kit PCB Layout Diagrams (continued)

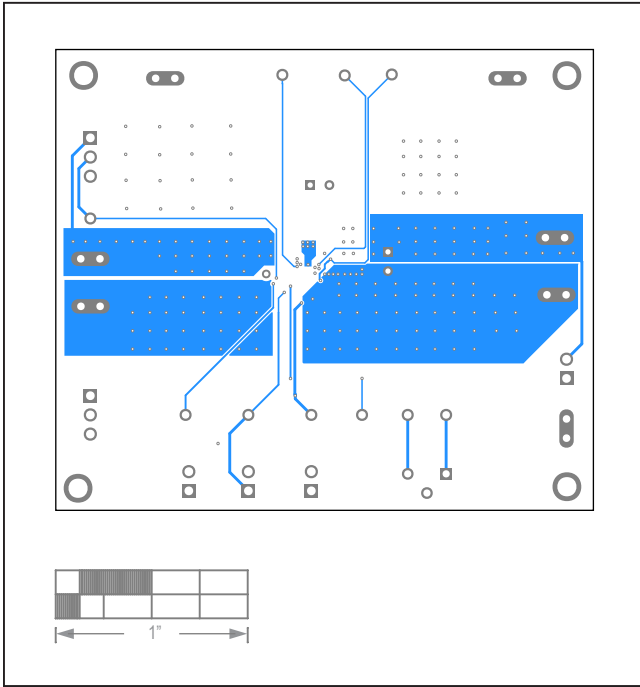

MAX77504 EV Kit PCB Layout—Bottom

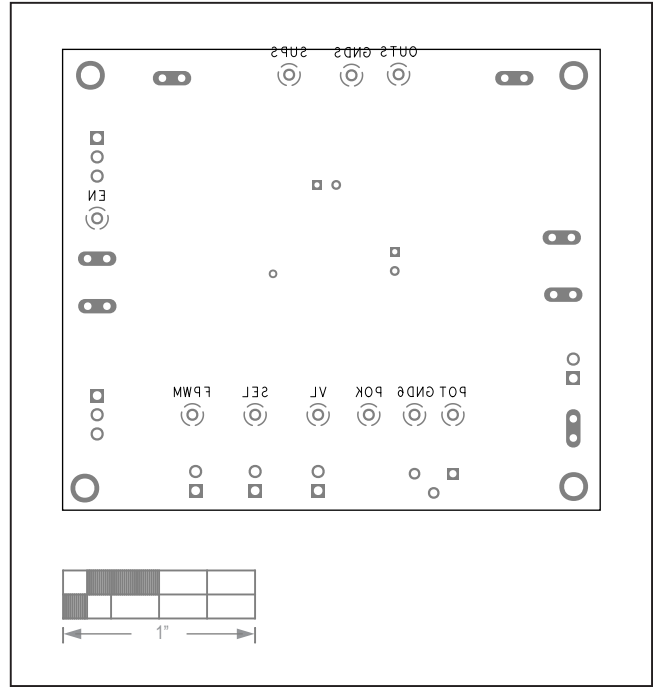

MAX77504 EV Kit Component Placement Guide—Bottom Silkscreen

Revision History

REVISION NUMBER	REVISION DATE	DESCRIPTION	PAGES CHANGED
0	2/20	Initial release	—

For pricing, delivery, and ordering information, please visit Maxim Integrated's online storefront at <https://www.maximintegrated.com/en/storefront/storefront.html>.

Maxim Integrated cannot assume responsibility for use of any circuitry other than circuitry entirely embodied in a Maxim Integrated product. No circuit patent licenses are implied. Maxim Integrated reserves the right to change the circuitry and specifications without notice at any time.