



# MAX6970 Evaluation Kit

## General Description

The MAX6970 evaluation kit (EV kit) provides a proven design to evaluate the MAX6970 eight-port, 36V constant-current LED driver. The EV kit also includes Windows® 2000/XP/Vista®-compatible software that provides a simple graphical user interface (GUI) for exercising the features of the MAX6970.

The MAX6970 EV kit PCB comes with a MAX6970AUE+ installed.

## Features

- ◆ Windows 2000/XP/Vista (32-Bit)-Compatible Software
- ◆ USB-PC Connection (Cable Included)
- ◆ USB Powered
- ◆ Optional External LED Supply Voltage
- ◆ Lead-Free and RoHS-Compliant
- ◆ Serial-Interface Terminals
- ◆ Proven PCB Layout
- ◆ Fully Assembled and Tested

## Ordering Information

PART	TYPE
MAX6970EVKIT+	EV Kit

+Denotes lead-free and RoHS-compliant.

## Component List

DESIGNATION	QTY	DESCRIPTION
C1, C12, C14	3	10 $\mu$ F $\pm$ 10%, 16V X5R ceramic capacitors (0805) KEMET C0805C106K4PACTU
C2, C3	2	22pF $\pm$ 5%, 50V C0G ceramic capacitors (0603) Murata GRM1885C1H220J
C4	1	0.033 $\mu$ F $\pm$ 10%, 16V X5R ceramic capacitor (0603) Taiyo Yuden EMK107BJ333KA
C5–C10, C17–C23	13	0.1 $\mu$ F $\pm$ 10%, 16V X7R ceramic capacitors (0603) TDK C1608X7R1C104K
C11, C13	2	1 $\mu$ F $\pm$ 10%, 16V X5R ceramic capacitors (0603) TDK C1608X5R1C105K
C15, C16	2	10pF $\pm$ 5%, 50V C0G ceramic capacitors (0603) Murata GRM1885C1H100J
C24	1	1 $\mu$ F $\pm$ 20%, 50V X5R ceramic capacitor (0805) AVX 080550105MAT2A
D1–D8	8	Red LEDs (0603)

DESIGNATION	QTY	DESCRIPTION
H1	0	Not installed, dual row 10-pin (2 x 5) header
JU1–JU15	15	3-pin headers
L1	1	Ferrite bead (0603) TDK MMZ1608R301A
P1	1	USB series B right-angle PC-mount receptacle
R1, R2	2	27 $\Omega$ $\pm$ 5% resistors (0603)
R3	1	1.5k $\Omega$ $\pm$ 5% resistor (0603)
R4	1	470 $\Omega$ $\pm$ 5% resistor (0603)
R5	1	2.2k $\Omega$ $\pm$ 5% resistor (0603)
R6	1	10k $\Omega$ $\pm$ 5% resistor (0603)
R7	1	169k $\Omega$ $\pm$ 1% resistor (0603)
R8	1	100k $\Omega$ $\pm$ 1% resistor (0603)
R9–R13	0	Not installed, resistors—short (PC trace) (0402)
R14	1	2.2k $\Omega$ $\pm$ 1% resistor (0603)
U1	1	8-port LED driver (16 TSSOP-EP*) Maxim MAX6970AUE+
U2	1	Microcontroller (68 QFN-EP*) Maxim MAXQ2000-RAX+

Windows and Windows Vista are registered trademarks of Microsoft Corp.



Maxim Integrated Products 1

**For pricing, delivery, and ordering information, please contact Maxim Direct at 1-888-629-4642, or visit Maxim's website at [www.maxim-ic.com](http://www.maxim-ic.com).**

Evaluates: MAX6970

# MAX6970 Evaluation Kit

## Component List (continued)

DESIGNATION	QTY	DESCRIPTION
U3	1	LDO regulator (5 SC70) Maxim MAX8511EXK25+ (Top Mark: ADV)
U4	1	Adjustable output LDO regulator (5 SC70) Maxim MAX8512EXK+ (Top Mark: ADW)
U5	1	UART-to-USB converter (32 TQFP) FTDI FT232BL
U6	1	93C46 type 3-wire EEPROM (8 SO) Atmel AT93C46A-10SU-2.7

DESIGNATION	QTY	DESCRIPTION
U7	1	Level translator (14 TSSOP) Maxim MAX3377EEUD+
U8	1	Level translator (5 SC70) Maxim MAX3370EXK+
Y1	1	16MHz crystal (HCM49)
Y2	1	6MHz crystal (HCM49)
—	15	Shunts
—	1	USB high-speed A-to-B cables, 6ft
—	1	PCB: MAX6970 Evaluation Kit+

\*EP = Exposed pad.

## Component Suppliers

SUPPLIER	PHONE	WEBSITE
AVX Corp.	843-946-0238	www.avxcorp.com
KEMET Corp.	864-963-6300	www.kemet.com
Murata Electronics North America, Inc.	770-436-1300	www.murata-northamerica.com
TDK Corp.	847-803-6100	www.component.tdk.com

**Note:** Indicate that you are using the MAX6970 when contacting these component suppliers.

## MAX6970 EV Kit Files

FILE	DESCRIPTION
INSTALL.EXE	Installs the EV kit files on your computer
MAX6970.EXE	Application program
FTD2XX.INF	USB device driver file
UNINST.INI	Uninstalls the EV kit software
USB_Driver_Help.PDF	USB driver installation help file

## Quick Start

### Required Equipment

Before beginning, the following equipment is needed:

- MAX6970 EV kit (USB cable included)
- A user-supplied Windows 2000/XP/Vista-compatible PC with a spare USB port

**Note:** In the following sections, software-related items are identified by bolding. Text in **bold** refers to items directly from the EV kit software. Text in **bold and underlined** refers to items from the Windows operating system.

### Procedure

The MAX6970 EV kit is fully assembled and tested. Follow the steps below to verify board operation:

- 1) Visit [www.maxim-ic.com/evkitsoftware](http://www.maxim-ic.com/evkitsoftware) to download the latest version of the EV kit software, 6970Rxx.ZIP. Save the EV kit software to a temporary folder and uncompress the ZIP file.
- 2) Install the EV kit software on your computer by running the INSTALL.EXE program inside the temporary folder. The program files are copied and icons are created in the Windows **Start | Programs** menu.
- 3) Verify that all jumpers (JU1–JU15) are in their default positions, as shown in Table 1.
- 4) Connect the USB cable from the PC to the EV kit board. A **New Hardware Found** window pops up when installing the USB driver for the first time. If you do not see a window that is similar to the one described above after 30s, remove the USB cable from the board and reconnect it. Administrator privileges are required to install the USB device driver on Windows 2000/XP/Vista.

# MAX6970 Evaluation Kit

- 5) Follow the directions of the **Add New Hardware Wizard** to install the USB device driver. Choose the **Search for the best driver for your device** option. Specify the location of the device driver to be **C:\Program Files\MAX6970** (default installation directory) using the **Browse** button. During device driver installation, Windows might show a warning message indicating that the device driver Maxim uses does not contain a digital signature. This is not an error condition and it is safe to proceed with installation. Refer to the USB\_Driver\_Help.PDF document for additional information.
- 6) Start the EV kit software by opening its icon in the **Start | Programs** menu. The EV kit software main window should appear as shown in Figure 1.
- 7) Wait for the EV kit to fully connect and click on the **DEMO** button. Verify that all the LEDs turn on, one by one, starting from **LED0** to **LED7** in the software and the EV kit.

## Detailed Description of Software

The main window of the evaluation software (shown in Figure 1) displays the state of each LED on the EV kit. Click the **LED0–LED7** icons located in the main window

to turn the LEDs on and off. A clear LED represents off and a red LED represents on. Other options include a **DEMO** and **CLEAR** button.

### Demo Button

Clicking the **DEMO** button always clears any previous on state of the LEDs before going into its sequence. The LEDs turn on, one by one, starting from **LED0** to **LED7**. At the end of the sequence, all LEDs are on. If the **Continuous Demo** checkbox is checked before the **DEMO** button is pressed, the demo sequence repeats continuously. During this routine, both **DEMO** and **CLEAR** buttons are disabled. To stop the demo, uncheck the **Continuous Demo** checkbox and the **DEMO** and **CLEAR** buttons are enabled.

### Clear Button

Clicking the **CLEAR** button turns off all the LEDs. When in demo mode, allow the sequence to finish before clicking the **CLEAR** button. If the **Continuous Demo** checkbox is checked and the **DEMO** button is pressed, the **CLEAR** button is disabled. To enable the **CLEAR** button, uncheck the **Continuous Demo** checkbox.

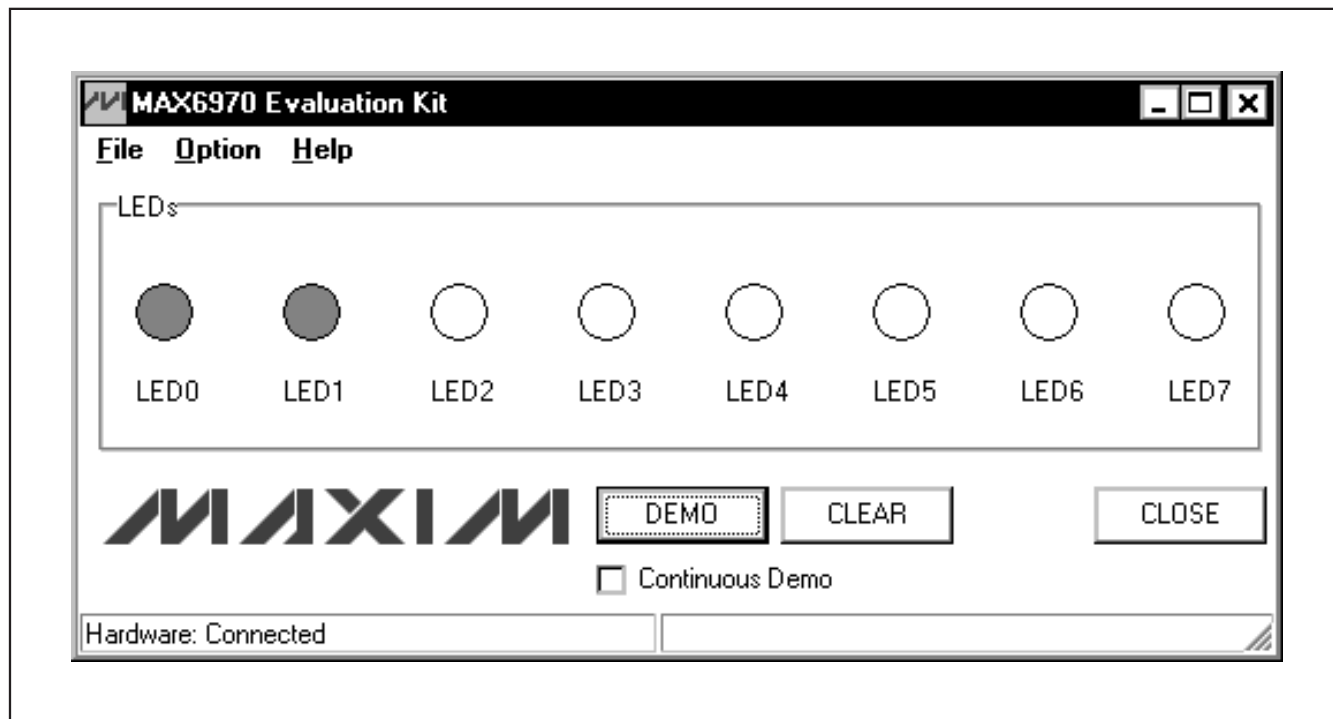

Figure 1. MAX6970 EV Kit Software Main Window

# MAX6970 Evaluation Kit

## Advanced Users Interface

In Figure 2, a serial interface can be used by advanced users by clicking **Option I Interface (Advanced Users)** from the MAX6970 EV kit main software window shown in Figure 1. Enter data into the **Data bytes to be written** edit box and press the **Send Now** button.

## Detailed Description of Hardware

The MAX6970 EV kit provides a proven layout for the MAX6970. On-board level translators, serial-interface pads, and an easy-to-use USB-PC connection are included on the EV kit.

## User-Supplied Serial Interface

To use the MAX6970 EV kit with a user-supplied serial interface, first move the shunts of jumpers JU1–JU5 and JU14 to the 2-3 position. Next, apply a 3.3V to 5V power supply at the VCC pad (see the *User-Supplied Power Supply* section). Lastly, connect user-supplied LE, SCLK, DIN, DOUT, and  $\overline{OE}$  signals to the corresponding pads on the MAX6970 EV kit board.

## User-Supplied Power Supply

The MAX6970 EV kit is powered completely from the USB port by default. Move the shunt of jumper JU14 to the 2-3 position and apply a 3.3V to 5V power supply at the VCC pad. The user can also apply a supply voltage up to 36V to the VLED pad after reconfiguring the JU15 to the 2-3 position.

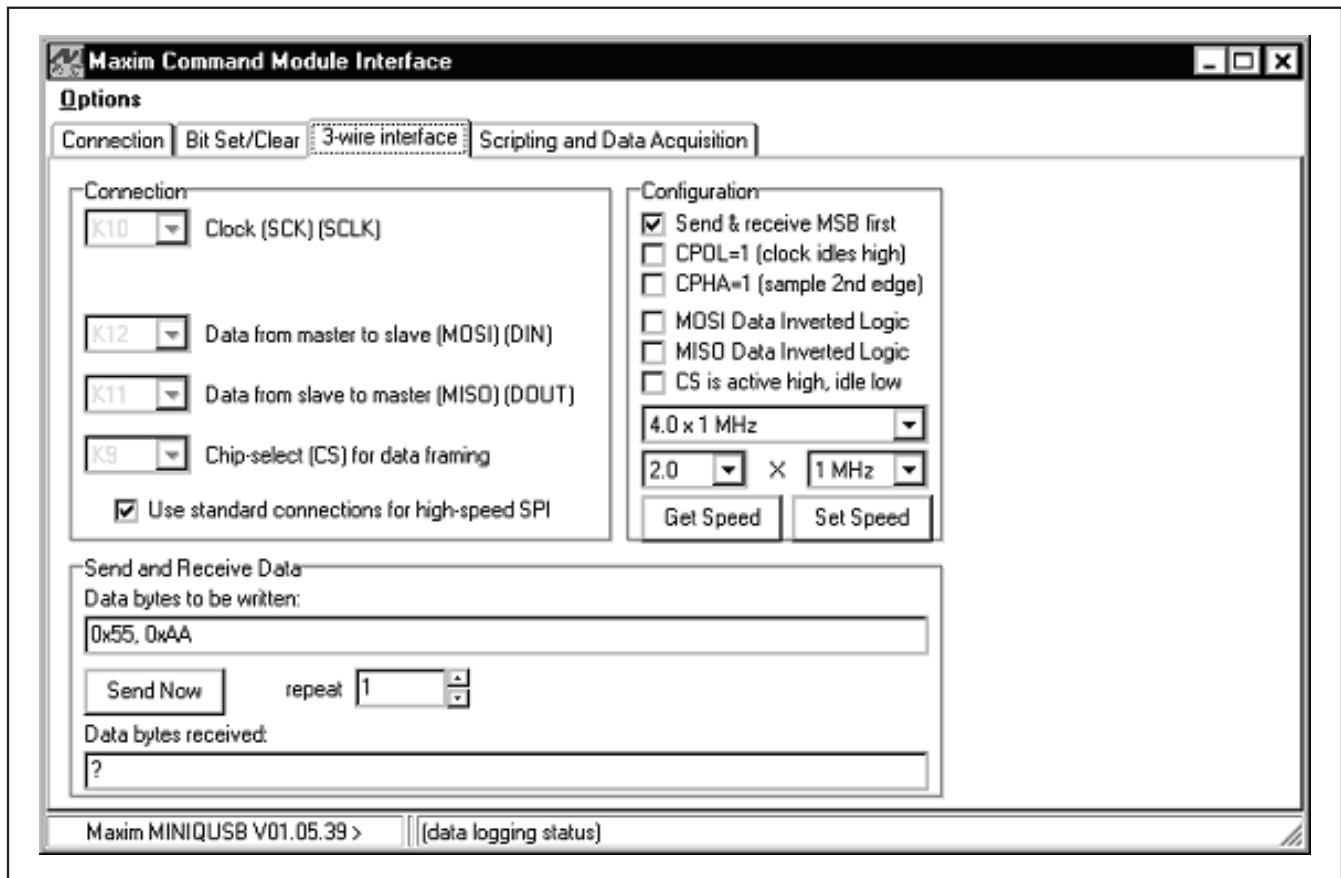

Figure 2. MAX6970 EV Kit Software Advanced Users Interface

# MAX6970 Evaluation Kit

Evaluates: MAX6970

**Table 1. MAX6970 EV Kit Jumper Descriptions (JU1–JU15)**

JUMPER	SHUNT POSITION	DESCRIPTION
JU1	1-2*	MAX6970 DIN signal connected to on-board microcontroller
	2-3	Connect user-supplied DIN signal to the on-board DIN pad
JU2	1-2*	MAX6970 SCLK signal connected to on-board microcontroller
	2-3	Connect user-supplied SCLK signal to the on-board SCLK pad
JU3	1-2*	MAX6970 LE signal connected to on-board microcontroller
	2-3	Connect user-supplied LE signal to the on-board LE pad
JU4	1-2*	MAX6970 DOUT signal connected to on-board microcontroller
	2-3	Connect user-supplied DOUT signal to the on-board DOUT pad
JU5	1-2*	MAX6970 $\overline{OE}$ signal connected to on-board microcontroller
	2-3	Connect user-supplied $\overline{OE}$ signal to the on-board $\overline{OE}$ pad
JU6	1-2*	Connect to on-board LED0 (D1)
	2-3	Connect user-supplied LED(s) to PORT0
JU7	1-2*	Connect to on-board LED1 (D2)
	2-3	Connect user-supplied LED(s) to PORT1
JU8	1-2*	Connect to on-board LED2 (D3)
	2-3	Connect user-supplied LED(s) to PORT2
JU9	1-2*	Connect to on-board LED3 (D4)
	2-3	Connect user-supplied LED(s) to PORT3
JU10	1-2*	Connect to on-board LED4 (D5)
	2-3	Connect user-supplied LED(s) to PORT4
JU11	1-2*	Connect to on-board LED5 (D6)
	2-3	Connect user-supplied LED(s) to PORT5
JU12	1-2*	Connect to on-board LED6 (D7)
	2-3	Connect user-supplied LED(s) to PORT6
JU13	1-2*	Connect to on-board LED7 (D8)
	2-3	Connect user-supplied LED(s) to PORT7
JU14	1-2*	Connect to on-board 5V (VUSB)
	2-3	Connect user-supplied 3.3V to 5V
JU15	1-2*	Connect to V+
	2-3	Connect to user-supplied VLED

\*Default position.

# MAX6970 Evaluation Kit

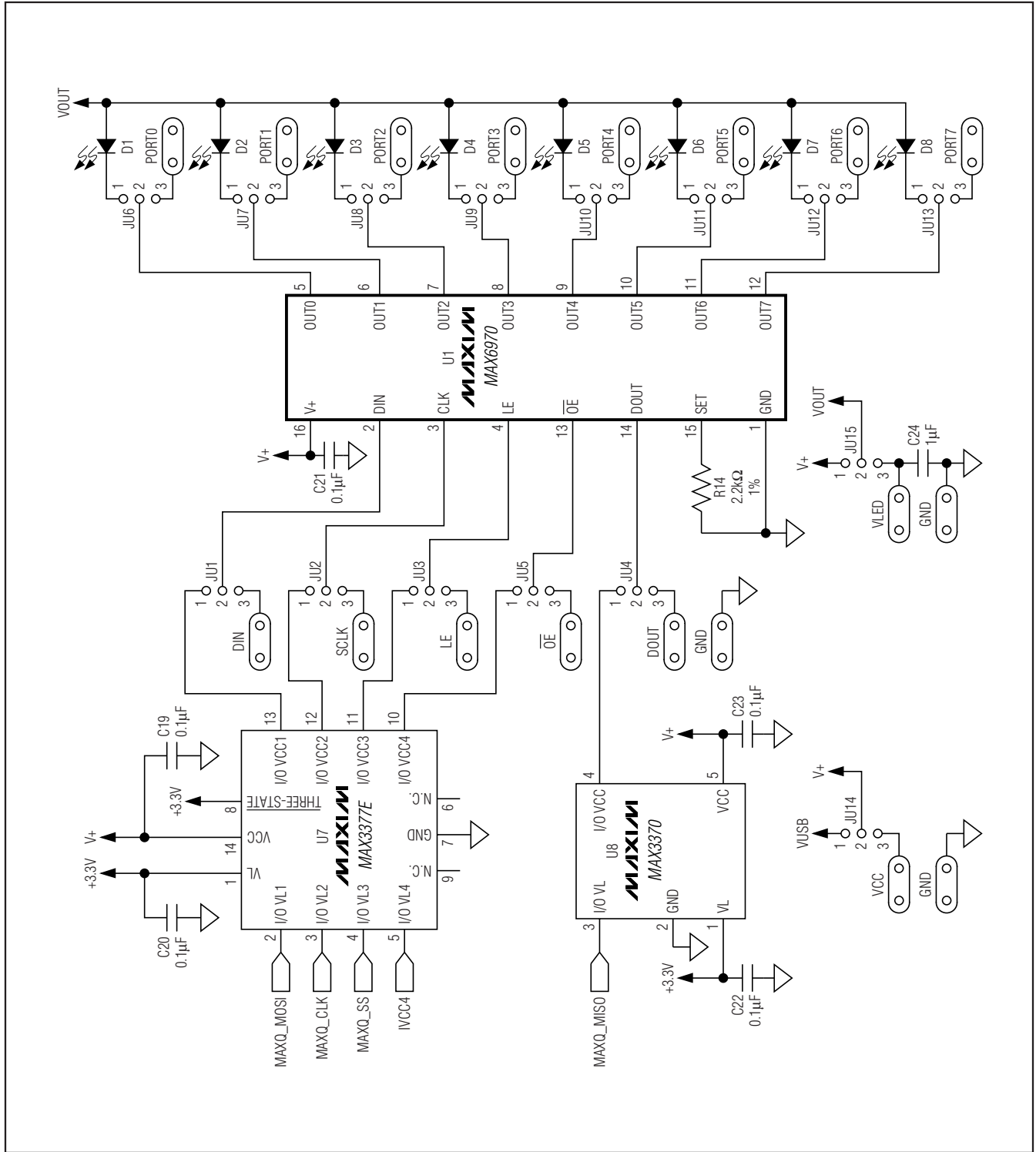

Figure 3a. MAX6970 EV Kit Schematic (Sheet 1 of 2)

# MAX6970 Evaluation Kit

Evaluates: MAX6970

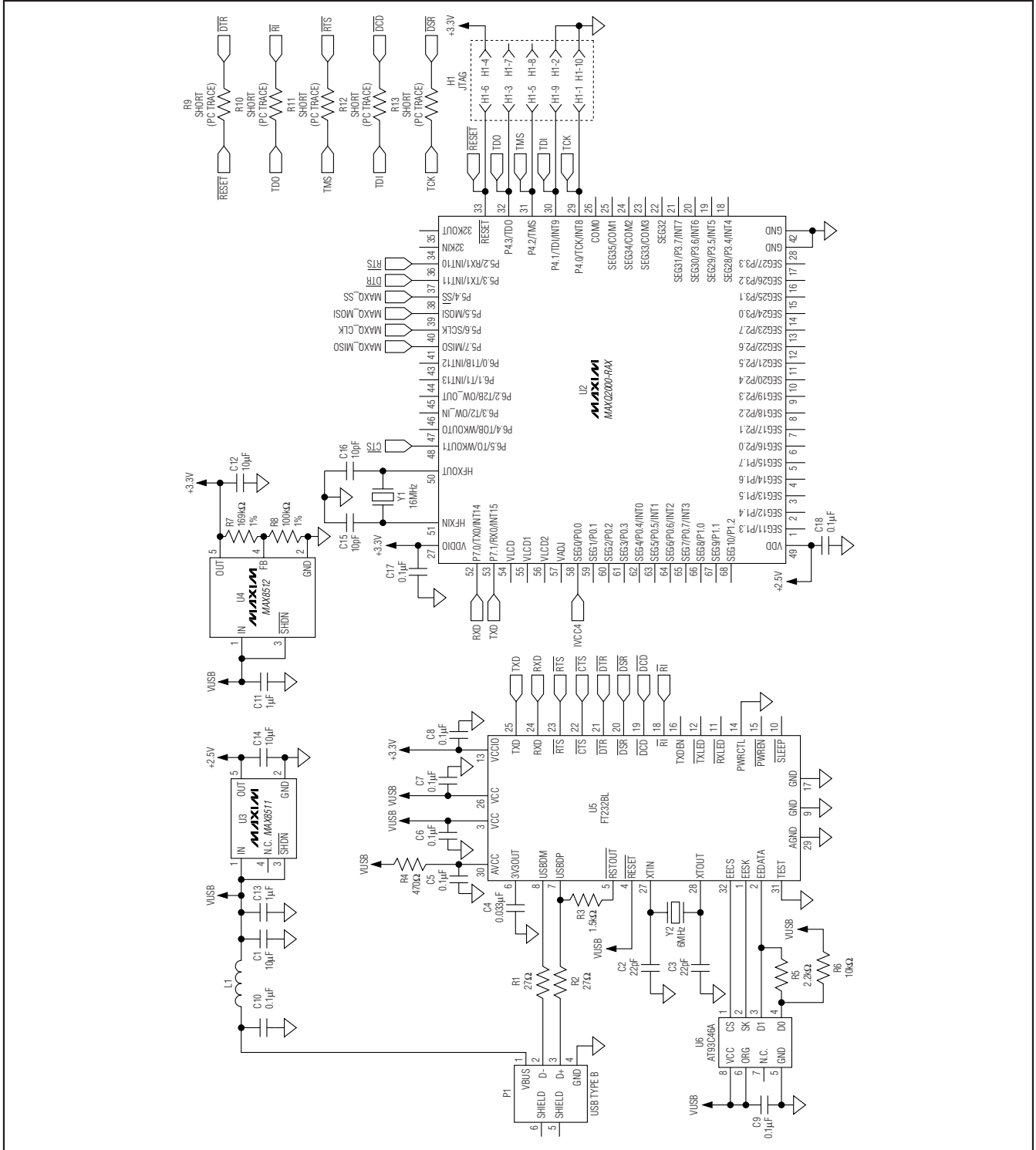

Figure 3b. MAX6970 EV Kit Schematic (Sheet 2 of 2)

# MAX6970 Evaluation Kit

Evaluates: MAX6970

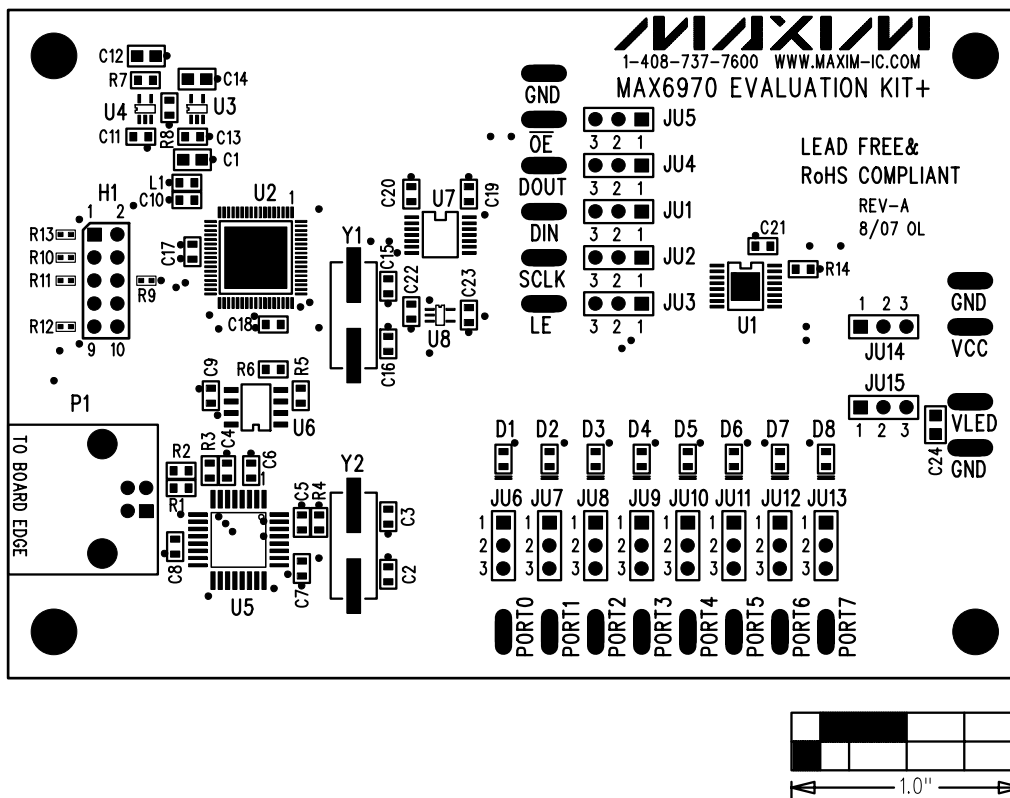

Figure 4. MAX6970 EV Kit Component Placement Guide—Component Side



# MAX6970 Evaluation Kit

Evaluates: MAX6970

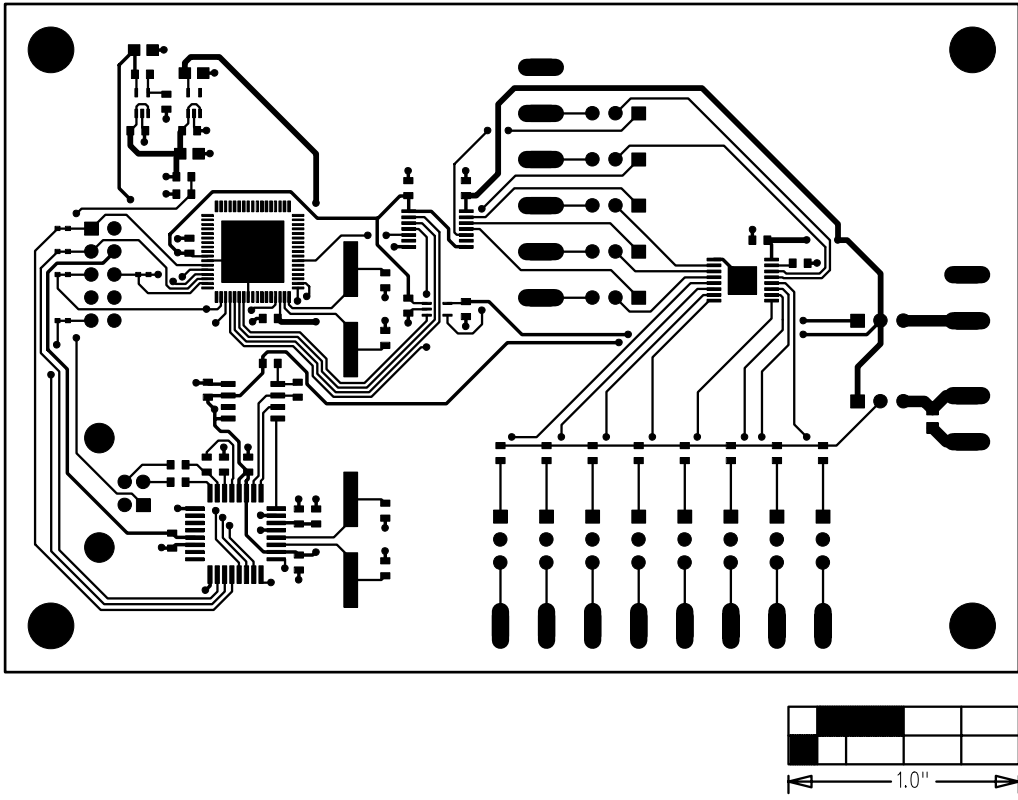

Figure 5. MAX6970 EV Kit PCB Layout—Component Side

# MAX6970 Evaluation Kit

Evaluates: MAX6970

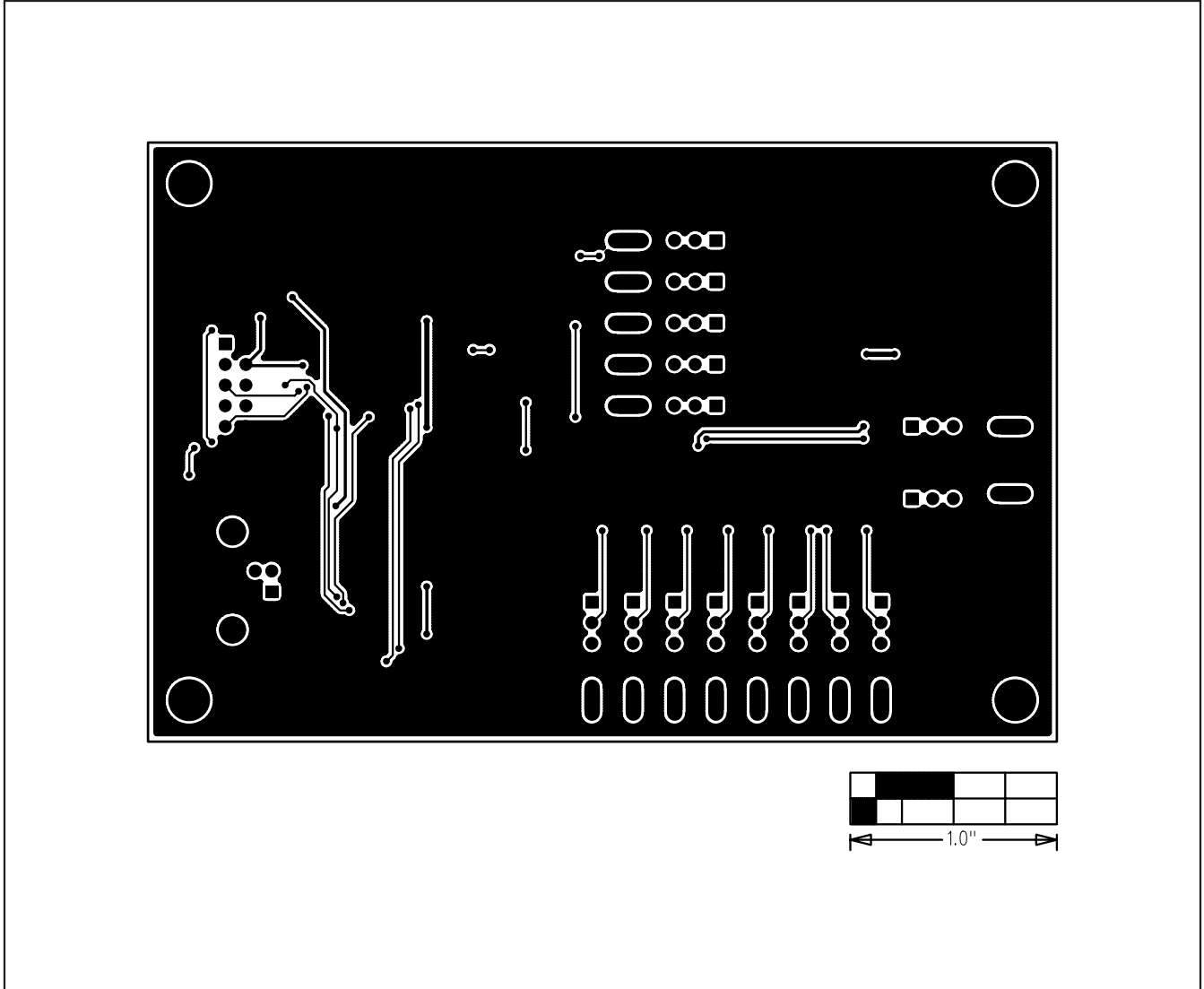

Figure 6. MAX6970 EV Kit PCB Layout—Solder Side

# MAX6970 Evaluation Kit

## Revision History

REVISION NUMBER	REVISION DATE	REVISION DESCRIPTION	PAGES CHANGED
0	11/07	Initial release	—
1	5/08	Corrected schematic (removed trace from FB to ground in component U4).	1, 2, 7

Evaluates: MAX6970

Maxim cannot assume responsibility for use of any circuitry other than circuitry entirely embodied in a Maxim product. No circuit patent licenses are implied. Maxim reserves the right to change the circuitry and specifications without notice at any time.

Maxim Integrated Products, 120 San Gabriel Drive, Sunnyvale, CA 94086 408-737-7600 \_\_\_\_\_ 11