

MAX5X05 Evaluation Kit

Evaluates: MAX5703, MAX5704, MAX5705A, MAX5705B, MAX5803, MAX5804, MAX5805A, MAX5805B

General Description

The MAX5X05 evaluation kit (EV kit) demonstrates the MAX5705 and MAX5805 12-bit, single-channel, low-power DACs with internal reference and buffered voltage output. The MAX5705 and the MAX5805 come in a 10-pin μ MAX[®] package. The EV kit provides controls to change the DAC output, power operations, and references.

The DAC ICs are controlled by an on-board MAXQ microcontroller, which provides two different interfaces: I²C and SPI. The EV kit features Windows XP[®]-, Windows Vista[®]-, and Windows[®] 7-compatible software, which provides a simple graphical user interface (GUI) for exercising the MAX5705 and the MAX5805 features.

The EV kit comes with the MAX5705AAUB+ (SPI) and the MAX5805AAUB+ (I²C) installed. Contact the factory for samples of the pin-compatible MAX5703AUB+ (SPI, 8-bit), MAX5704AUB+ (SPI, 10-bit), MAX5705BAUB+ (SPI, 10-bit), MAX5803AUB+ (I²C, 8-bit), MAX5804AUB+ (I²C, 10-bit), MAX5805BAUB+ (I²C, 12-bit).

Component List

DESIGNATION	QTY	DESCRIPTION
ADDR, CSB, DIN, SCL, SCLK, SDA, U1_AUX, U1_LDAC, U1_OUT, U1_REF, U2_AUX, U2_LDAC, U2_OUT, U2_REF, VDD, VDDIO	16	Red test points
AGND (x2), DGND (x2), GNDS (x2)	6	Black test points

Windows, Windows XP, and Windows Vista are registered trademarks and registered service marks of Microsoft Corporation.

Features

- Wide 2.7V to 5.5V Input Supply Range
- Demonstrates 6.3 μ s Settling Time of Buffered Output
- High Precision with ± 1 LSB INL
- Selectable Output Termination: 1k Ω , 100k Ω , or High Impedance
- Precision 10ppm (max) Selectable Internal References: 2.048V, 2.500V, and 4.096V
- Demonstrates User-Supplied External Reference
- Supports Entire Family of I²C and SPI 12-/10-/8-Bit DACs
- Windows XP-, Windows Vista-, and Windows 7-Compatible Software
- USB-Powered (Cable Included)
- Fully Assembled and Tested with Proven PCB Layout

Ordering Information appears at end of data sheet.

DESIGNATION	QTY	DESCRIPTION
C1, C6–C9, C19–C22, C24, C27, C28, C30–C32	15	1 μ F $\pm 10\%$, 16V X7R ceramic capacitors (0603) Murata GRM188R71C105K
C2, C5, C12–C14, C18, C23, C29, C33	9	0.1 μ F $\pm 10\%$, 16V X7R ceramic capacitors (0603) Murata GRM188R71C104K
C3, C11, C17	0	Not installed, ceramic capacitors (0603)
C4, C10, C25, C26	4	200pF $\pm 5\%$, 50V C0G ceramic capacitors (0603) Murata GRM1885C1H201J
C15, C16	2	18pF $\pm 5\%$, 50V C0G ceramic capacitors (0603) Murata GRM1885C1H180J

μ MAX is a registered trademark of Maxim Integrated Products, Inc.



MAX5X05 Evaluation Kit

Evaluates: MAX5703, MAX5704, MAX5705A, MAX5705B, MAX5803, MAX5804, MAX5805A, MAX5805B

Component List (continued)

DESIGNATION	QTY	DESCRIPTION
H1	0	Not installed, 4-pin header
H2	1	10-pin (2 x 5) header
JU1, JU2, JU4, JU5, JU7–JU11, JU14, JU15	11	2-pin headers
JU3, JU6, JU12, JU13	4	3-pin headers
JU_ID0–JU_ID3	0	Not installed, 2-pin headers
L1	1	Ferrite bead (0603) TDK MMZ1608R301A
R1, R2	2	4.7kΩ ±5% resistors (0603)
R3, R7, R15, R16	4	1MΩ ±5% resistors (0603)
R4–R6, R13	4	1.5kΩ ±5% resistors (0603)
R8	1	100Ω ±5% resistor (0603)
R9	1	10kΩ ±5% resistor (0603)
R10, R11	2	2kΩ ±5% resistors (0603)
U1	1	12-bit DAC (10 μMAX) Maxim MAX5805AAUB+

DESIGNATION	QTY	DESCRIPTION
U2	1	12-bit DAC (10 μMAX) Maxim MAX5705AAUB+
U3	0	Not installed, 4.5V reference (6 SOT23)
U4, U6, U9	3	Level translators (10 μMAX) Maxim MAX1840EUB+
U5	0	ESD protector Not installed (6 SOT23)
U7	1	3.3V LDO (5 SC70) Maxim MAX8511EXK33+
U8	1	Microcontroller (64 LQFP) Maxim MAXQ622G-0000+
USB1	1	Mini-USB type-B right-angle PC-mount receptacle
Y1	1	12MHz crystal (HCM49)
—	1	MAX5X05 EV kit CD
—	1	USB high-speed A-to-mini-B cable (6ft)
—	15	Shunts
—	1	PCB: MAX5X05 EVALUATION KIT

Component Suppliers

SUPPLIER	PHONE	WEBSITE
Hong Kong X'tals Ltd.	852-35112388	www.hongkongcrystal.com
Murata Electronics North America, Inc.	770-436-1300	www.murata-northamerica.com
TDK Corp.	847-803-6100	www.component.tdk.com

Note: Indicate that you are using the MAX5X05 EV kit when contacting these component suppliers.

MAX5X05 EV Kit Files

FILES	DESCRIPTION
INSTALL.EXE	Installs the EV kit files on your computer
MAX5X05.EXE	Application program
USBConverterDLL.DLL	Application library
UNINSTALL.EXE	Uninstalls the EV kit software

MAX5X05 Evaluation Kit

Evaluates: MAX5703, MAX5704, MAX5705A, MAX5705B, MAX5803, MAX5804, MAX5805A, MAX5805B

Quick Start

Required Equipment

- MAX5X05 EV kit (USB cable included)
- Windows XP, Windows Vista, or Windows 7 PC with a spare USB port
- Two digital voltmeters (DVM)

Note: In the following sections, software-related items are identified by bolding. Text in **bold** refers to items directly from the EV kit software. Text in **bold and underlined** refers to items from the Windows operating system.

Procedure

The EV kit is fully assembled and tested. Follow the steps below to verify board operation:

- 1) Verify that jumpers JU1–JU15 are in their default position, as shown in Table 1.
- 2) Connect the bottom GNDS pad to the negative terminal of the DVM #1 and connect the positive terminal to measure the voltage at the U2_OUT test points.
- 3) Connect the GNDS pad for the negative terminal of the DVM #2 and connect the positive terminal to measure the voltage at the U1_OUT test points.
- 4) Visit www.maximintegrated.com/evkitsoftware to download the most recent version of the EV kit software, 5X05Rxx.ZIP. Save the EV kit software to a temporary folder and uncompress the ZIP file.
- 5) Install the EV kit software on your computer by running the INSTALL.EXE program inside the temporary folder. The program files are copied to your PC and icons are created in the Windows **Start | Programs** menu.
- 6) Connect the USB cable from the PC to the EV kit board; the USB driver is installed automatically.
- 7) Start the MAX5X05 EV kit software by opening its icon in the **Start | Programs** menu. The EV kit software main window appears as shown in Figure 1.
- 8) Within the **Reference** group box, select the **2.500V** radio button and press the **Execute** button.
- 9) Within the **DAC** group box, select the **Code and Load** selection from the **Command** drop-down list and drag the scrollbar to the right until the data reaches 0xFF.
- 10) Verify that DVM #1 measured 2.5V.
- 11) Select the **I2C** radio button and the GUI automatically detects the I2C address.
- 12) Within the **Reference** group box, the 2.500V radio button is already selected. Press the **Execute** button.
- 13) Verify that DVM #2 measured 2.5V.

Detailed Description of Software

The MAX5X05 EV kit software can evaluate all I2C and SPI interface family of devices. In addition to the interfaces, the software allows 12-/10-/8-bit DAC part selection.

Part Selection

On the upper-left corner is a **Part Selection** group box. The user must select the appropriate radio button that corresponds to the installed Maxim IC DAC bits.

Interface

The **Interface** group box allows the user to toggle between I2C and SPI DAC parts. By default, the software is configured to communicate using the SPI interface first. Once the **I2C** radio button selection is made, the software automatically detects the correct I2C address from the drop-down list and the user is allowed to communicate using the I2C interface. See Table 2 for a list of the I2C addresses.

Command

Choose the appropriate **Command** from the drop-down list and drag the **Data** scrollbar to start writing data. Optionally, the user can enter the desired data in the **Data** edit box and press the **Execute** button. Refer to the MAX5805 and MAX5705 IC data sheets for a list of possible commands.

Asynchronous $\overline{\text{LDAC}}$

A checked $\overline{\text{LDAC}}$ checkbox drives the $\overline{\text{LDAC}}$ pin of the MAX5705 or MAX5805 low, which allows the changes to the CODE register to change the DAC output. Unchecking the $\overline{\text{LDAC}}$ checkbox drives the $\overline{\text{LDAC}}$ pin of the MAX5705 or MAX5805 high. To change the DAC output, the user must write to the CODE registers, and then write to the DAC registers.

Software Reset

The **Software Reset** group box allows the user to issue several flexible software resets: END, GATE, CLEAR, and RESET. Refer to the MAX5805 and MAX5705 IC data sheets for a detailed description of the software reset command.

Configuration

The **Configuration** group box controls the $\overline{\text{AUX}}$ pin of the MAX5705 and/or the MAX5805. The different functions include GATE, LOAD, CLEAR, and NONE. Once the appropriate selection is made, the $\overline{\text{AUX}}$ pin can be driven high, low, or pulsed. Refer to the MAX5805 and MAX5705 IC data sheets for a detailed description of $\overline{\text{AUX}}$ pin functions.

MAX5X05 Evaluation Kit

Evaluates: MAX5703, MAX5704, MAX5705A, MAX5705B, MAX5803, MAX5804, MAX5805A, MAX5805B

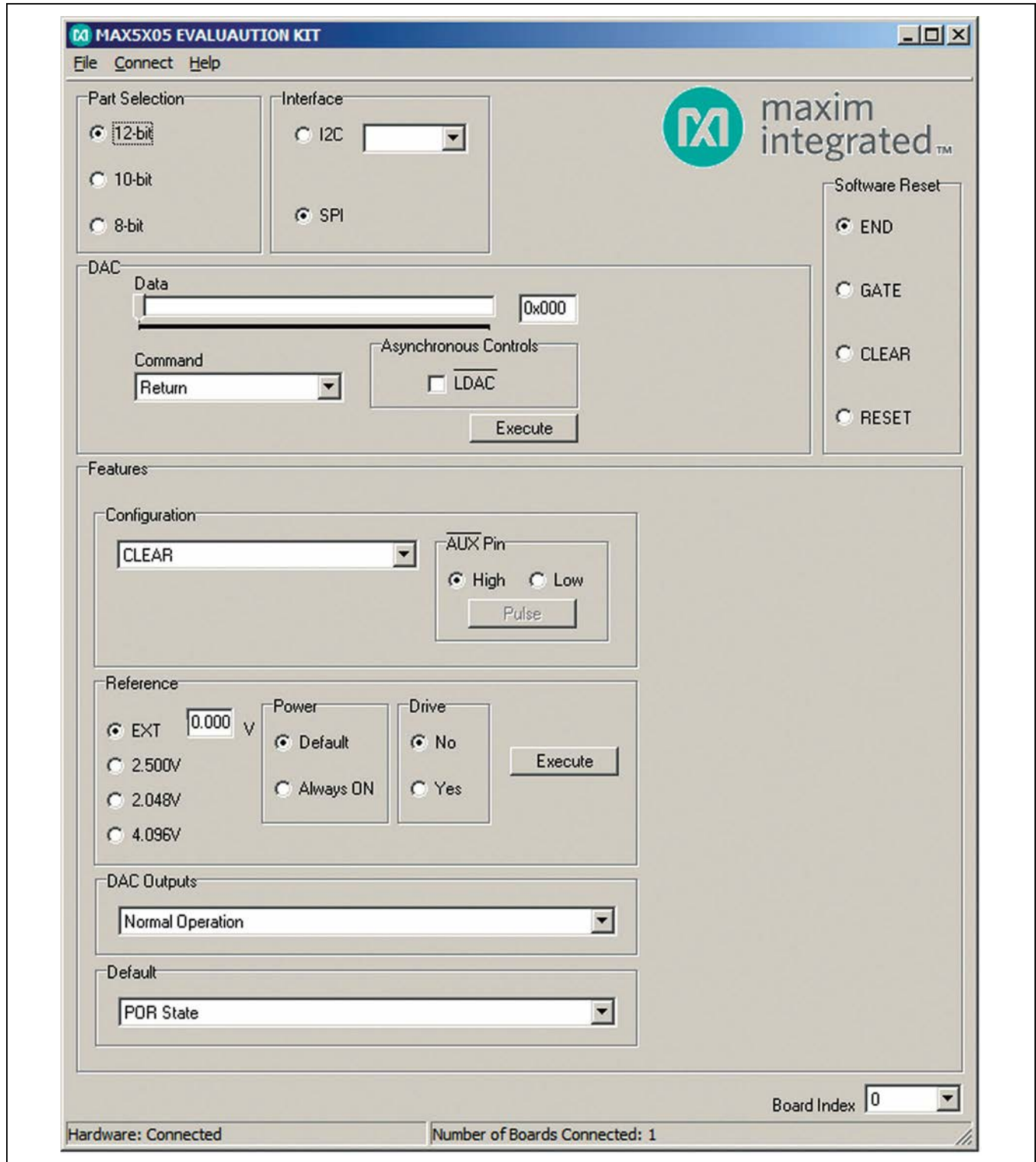

Figure 1. MAX5X05 EV Kit Software Main Window (SPI)

MAX5X05 Evaluation Kit

Evaluates: MAX5703, MAX5704, MAX5705A, MAX5705B, MAX5803, MAX5804, MAX5805A, MAX5805B

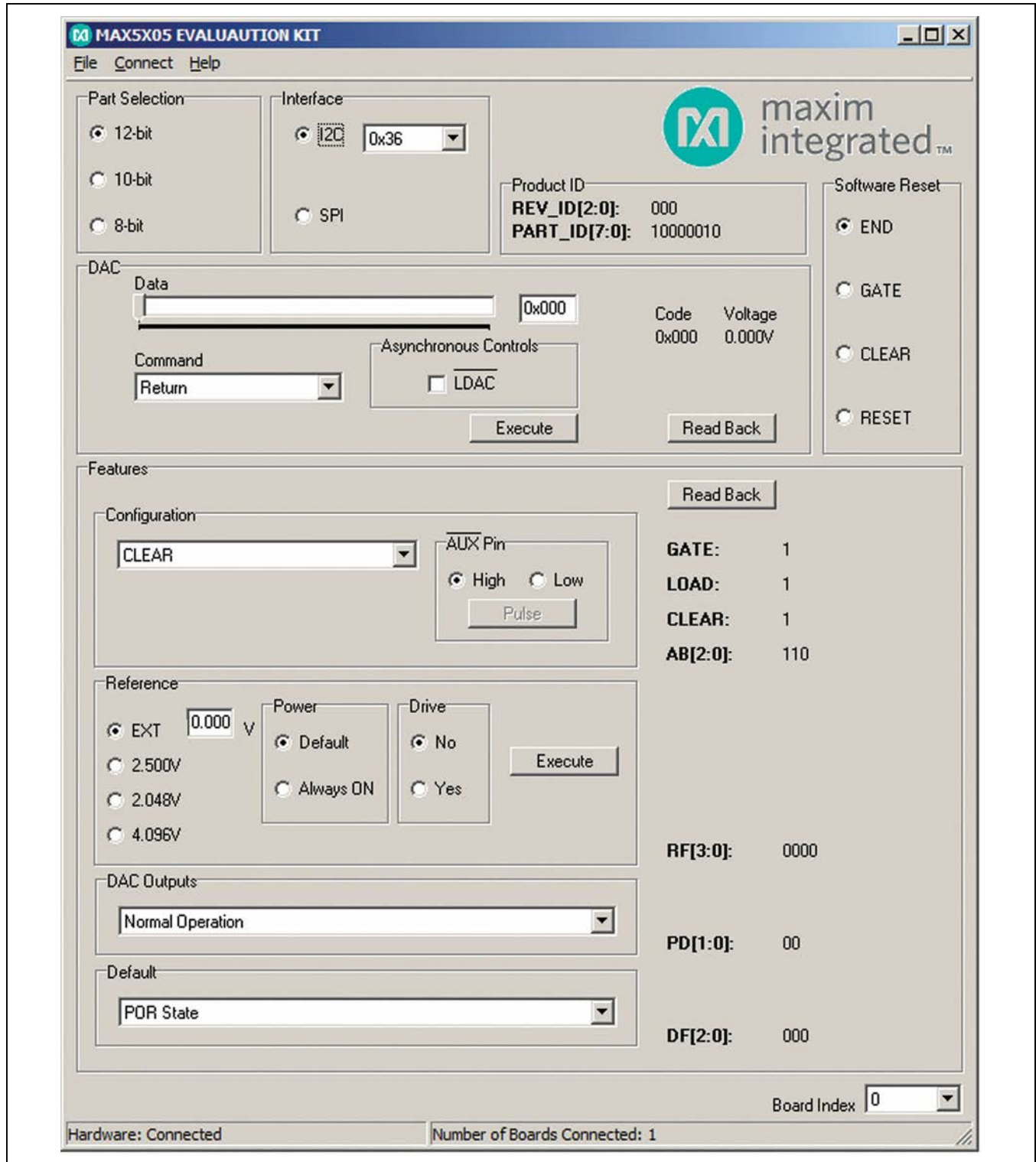

Figure 2. MAX5X05 EV Kit Software Main Window (I2C)

MAX5X05 Evaluation Kit

Evaluates: MAX5703, MAX5704, MAX5705A, MAX5705B, MAX5803, MAX5804, MAX5805A, MAX5805B

Reference

The user can select from an external or internal reference using software commands. When setting the reference, confirm that the VDD supply is greater or equal to the voltage reference selected for proper operation. To use the external reference, the user must select the **EXT** radio button and enter a valid voltage in the edit box. The internal reference options include 2.048V, 2.500V, and 4.096V. Select the **Always ON** radio button if the reference needs to always be on. The **Default** radio button selection powers down when the DAC powers down. Selecting the **Yes** radio button drives the internal reference circuit and draws an additional 25µA of current when powered. Once the appropriate selection is made, press the **Execute** button.

DAC Outputs

When the output of the DAC is not in normal operation, the output can be powered down with 1kΩ termination to GND, 100kΩ termination to GND, or high impedance

Default

The **Default** drop-down list sets the default value for the DAC and can be set to the POR state, zero scale, midscale, full scale, or return register values. Use these functions after performing a GATE or CLEAR in the configuration settings.

Read Back (I²C Only)

When the I²C part is selected, the product ID is read when an address is detected.

Within the **DAC** group box, press the **Read Back** button and the code and voltage of the DAC is displayed.

Within the **Features** group box, press the **Read Back** button and the configuration, reference, output, and default registers are read.

Multiple EV Kits

The software can communicate to multiple MAX5X05 EV kits connected to the USB ports of the PC. The status bar at the bottom of the GUI shows the number of boards that are connected. If all boards that are connected to the PC are not connected to the GUI, click the **Connect** menu and the status bar should be updated. Use the **Board Index** drop-down list to select the appropriate EV kit for communications.

Detailed Description of Hardware

The MAX5X05 EV kit provides a proven layout for the MAX5705 and the MAX5805. An on-board MAXQ622 microcontroller and jumpers to disconnect the on-board microcontroller are included on the EV kit.

Table 1. Jumper Settings (JU1–JU15)

JUMPER	SHUNT POSITION	DESCRIPTION
JU1	Installed*	Connects pullup resistor R1 to the I ² C SDA signal.
	Not installed	Disconnects pullup resistor R1 from the SDA pin of IC U1.
JU2	Installed*	Connects pullup resistor R2 to the I ² C SCL signal.
	Not installed	Disconnects pullup resistor R2 from the SCL pin of IC U1.
JU3	1-2*	Connects ADDR pin of IC U1 to VDDIO to determine the I ² C address (see Table 2).
	2-3	Connects ADDR pin of IC U1 to DGND to determine the I ² C address (see Table 2).
	Not installed	ADDR pin of IC U1 is not connected to determine the I ² C address (see Table 2).
JU4	Installed*	Connects the A $\bar{U}X$ signal of the on-board microcontroller to the A $\bar{U}X$ pin of IC U1.
	Not installed	Disconnects the A $\bar{U}X$ signal of the on-board microcontroller to the A $\bar{U}X$ pin of IC U1.
JU5	Installed	Connects load capacitor C25 and resistor R10 to the DAC output of IC U1.
	Not installed*	Disconnects load capacitor C25 and resistor R10 to the DAC output of IC U1.
JU6	1-2*	Connects the VDD pins of IC U1 and U2 to the on-board +3.3V supply.
	1-3	Connects the VDD pins of IC U1 and U2 to a user-supplied power supply between +2.5V and +5.5V.
	Not installed	User-supplied VDD. The user must apply a voltage at the VDD test point.
JU7	Installed*	Connects the DIN signal of the on-board microcontroller to the DIN pin of IC U2.
	Not installed	Disconnects the DIN signal of the on-board microcontroller to the DIN pin of IC U2.
JU8	Installed*	Connects the SCLK signal of the on-board microcontroller to the DIN pin of IC U2.
	Not installed	Disconnects the SCLK signal of the on-board microcontroller to the SCLK pin of IC U2.
JU9	Installed*	Connects the CSB signal of the on-board microcontroller to the $\bar{C}S$ pin of IC U2.
	Not installed	Disconnects the CSB signal of the on-board microcontroller to the $\bar{C}S$ pin of IC U2.

Table 1. Jumper Settings (JU1–JU15) (continued)

JUMPER	SHUNT POSITION	DESCRIPTION
JU10	Installed*	Connects the $\overline{\text{AUX}}$ signal of the on-board microcontroller to the $\overline{\text{AUX}}$ pin of IC U2.
	Not installed	Disconnects the $\overline{\text{AUX}}$ signal of the on-board microcontroller to the $\overline{\text{AUX}}$ pin of IC U2.
JU11	Installed	Connects load capacitor C26 and resistor R11 to the DAC output of IC U2.
	Not installed*	Disconnects load capacitor C26 and resistor R11 to the DAC output of IC U2.
JU12	1-2*	Connects on-board voltage reference IC (U3) to the REF pin of IC U1.
	2-3	Connects on-board voltage reference IC (U3) to the REF pin of IC U2.
	Not installed	User-supplied REF. The user must apply a voltage reference at the U1_REF and/or U2_REF test point(s).
JU13	1-2*	Connects the VDDIO pins of IC U1 and U2 to the on-board +3.3V supply.
	1-3	Connects the VDDIO pins of IC U1 and U2 to a user-supplied power supply between +2.5V and +5.5V.
	Not installed	User-supplied VDDIO. The user must apply a voltage at VDDIO test point.
JU14	Installed*	Connects the $\overline{\text{LDAC}}$ signal of the on-board microcontroller to the $\overline{\text{LDAC}}$ pin of IC U1.
	Not installed	Disconnects the $\overline{\text{LDAC}}$ signal of the on-board microcontroller to the $\overline{\text{LDAC}}$ pin of IC U1.
JU15	Installed*	Connects the $\overline{\text{LDAC}}$ signal of the on-board microcontroller to the $\overline{\text{LDAC}}$ pin of IC U2.
	Not installed	Disconnects the $\overline{\text{LDAC}}$ signal of the on-board microcontroller to the $\overline{\text{LDAC}}$ pin of IC U2.

*Default position.

Table 2. I²C Address Setting (JU3)

SHUNT POSITION (ADDR)	MAX5805 ADDRESS (hex)	
	WRITE	READ
1-2*	0x36	0x37
2-3	0x30	0x31
Not installed	0x34	0x35

*Default position.

I²C Address

The I²C address of the MAX5805 is determined by the shunt setting of jumper JU3. See Table 2 for all possible hexadecimal addresses.

User-Supplied Power Supply

The EV kit is powered completely from the USB port by default. To power the MAX5705 and MAX5805 with a user-supplied power supply, remove the shunt on jumper JU6 and apply a 2.7V to 5.5V power supply at the VDD test point and the nearest AGND test point on the EV kit.

A user-supplied VDDIO power supply can also be used by removing the shunt on jumper JU13 and applying 2.5V to 5.5V to the VDDIO test point and the nearest AGND test point on the EV kit.

User-Supplied Reference

The user can apply a user-supplied voltage reference by removing the shunt on jumper JU12 and applying 2V to VDD at the U1_REF and/or U2_REF test points on the EV kit.

User-Supplied SPI

To evaluate the EV kit with a user-supplied SPI bus, remove shunts from jumpers JU7–JU9. Apply the user-supplied SPI signals to the DIN, SCLK, and CSB test points and use the nearest DGND test point for the return ground on the EV kit.

User-Supplied I²C

To evaluate the EV kit with a user-supplied I²C bus, remove shunts from jumpers JU1 and JU2. Apply the user-supplied I²C signals to the SCL and SDA test points and use the nearest DGND test point for the return ground on the EV kit. If pullup resistors are on the user-supplied interface, resistors R1 and R2 should be removed.

User-Supplied $\overline{\text{LDAC}}$

A user-supplied $\overline{\text{LDAC}}$ signal can be used by removing shunts from jumper JU14 and/or JU15. Apply the user-supplied $\overline{\text{LDAC}}$ signal to U1_LDAC for the MAX5805 and/or U2_LDAC for the MAX5705, and use the nearest DGND test point for the return ground on the EV kit.

User-Supplied $\overline{\text{AUX}}$

A user-supplied $\overline{\text{AUX}}$ signal can be used by removing shunts from jumper JU4 and/or JU10. Apply the user-supplied $\overline{\text{AUX}}$ signal to U1_AUX for the MAX5805 and/or U2_AUX for the MAX5705, and use the nearest DGND test point for the return ground on the EV kit.

MAX5X05 Evaluation Kit

Evaluates: MAX5703, MAX5704,
MAX5705A, MAX5705B, MAX5803,
MAX5804, MAX5805A, MAX5805B

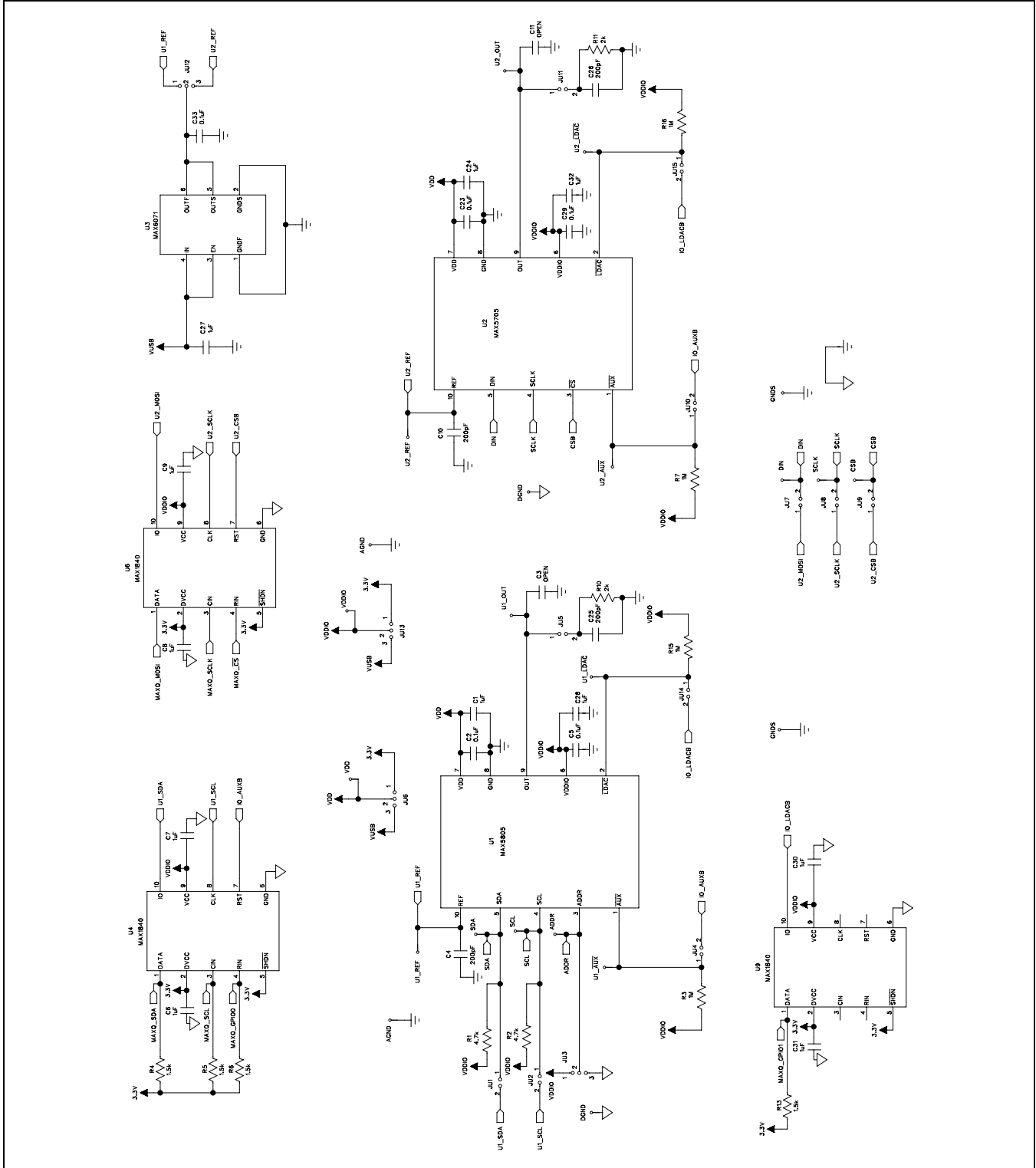

Figure 3a. MAX5X05 EV Kit Schematic (Sheet 1 of 2)

MAX5X05 Evaluation Kit

Evaluates: MAX5703, MAX5704, MAX5705A, MAX5705B, MAX5803, MAX5804, MAX5805A, MAX5805B

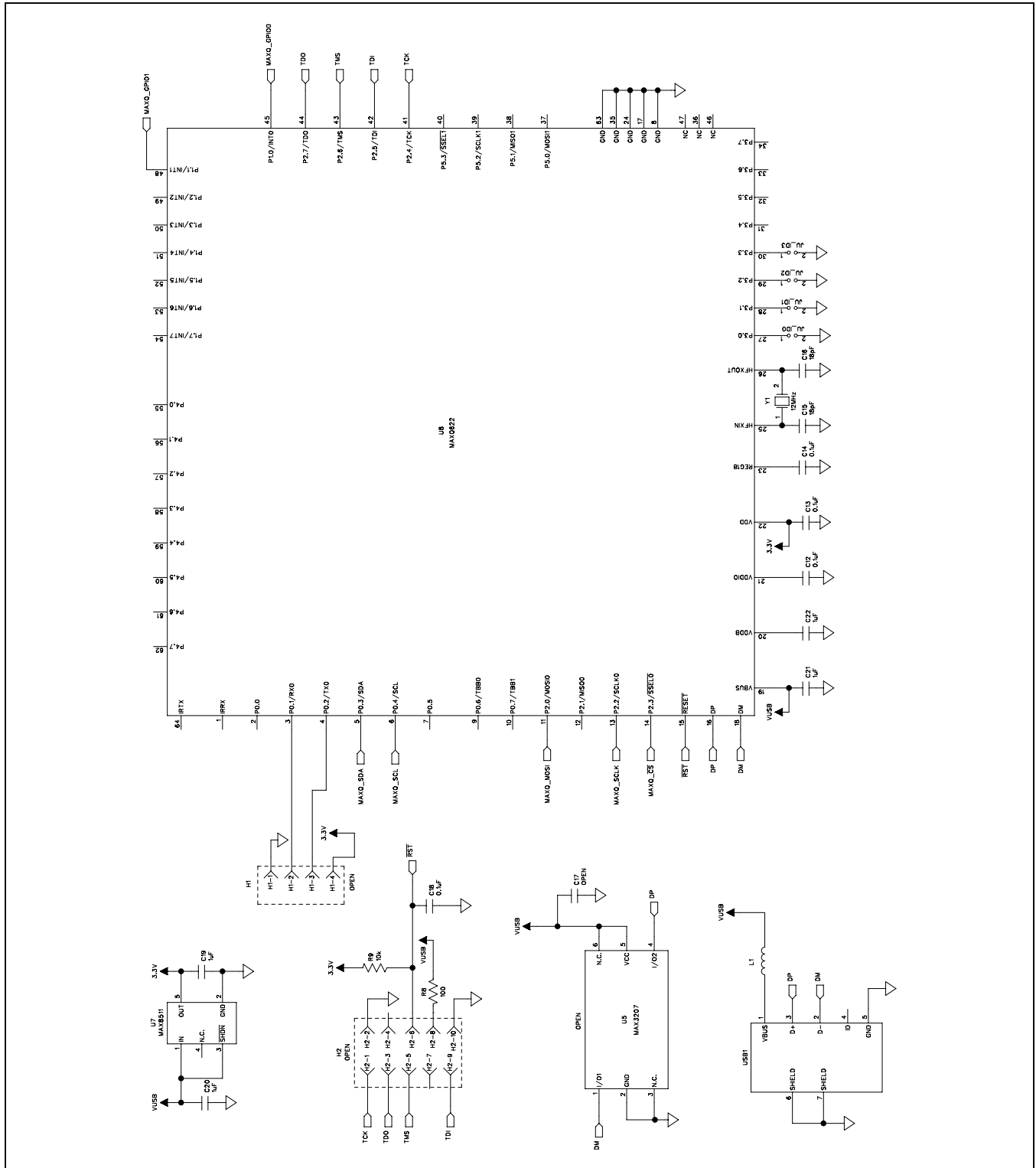

Figure 3b. MAX5X05 EV Kit Schematic (Sheet 2 of 2)

MAX5X05 Evaluation Kit

Evaluates: MAX5703, MAX5704,
MAX5705A, MAX5705B, MAX5803,
MAX5804, MAX5805A, MAX5805B

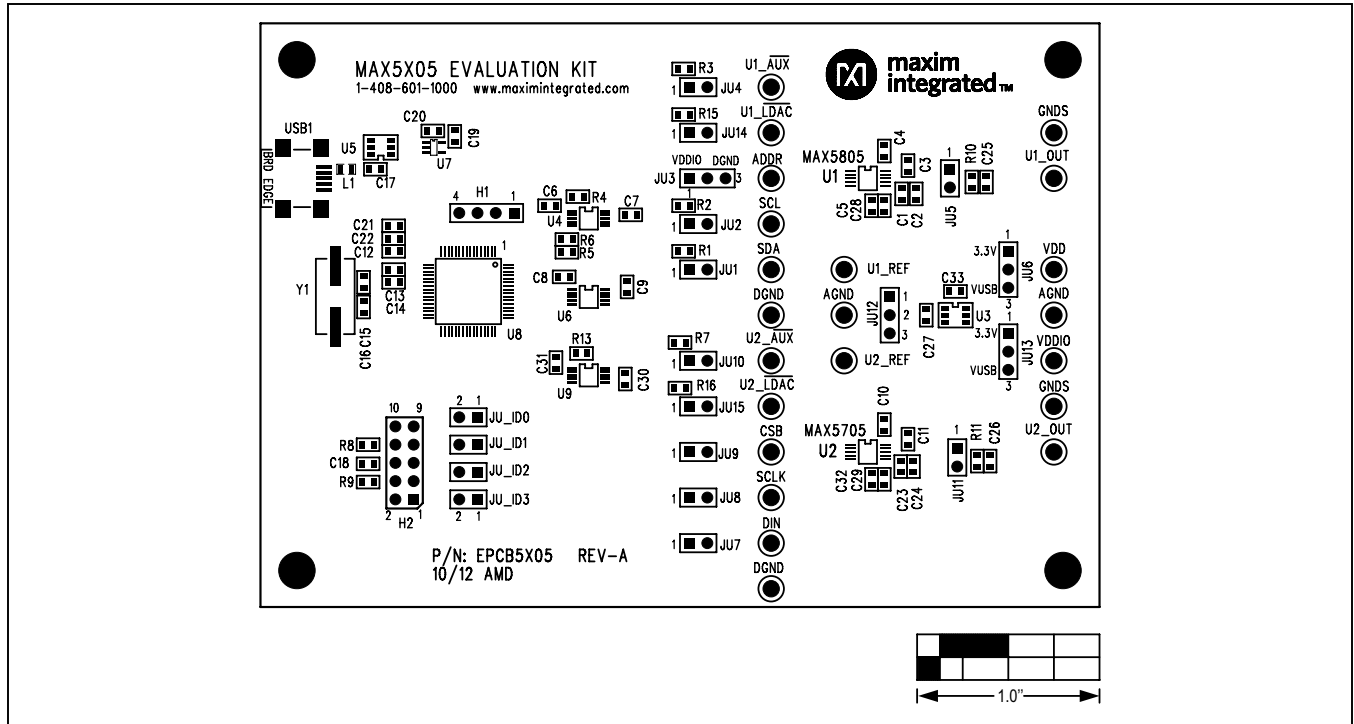

Figure 4. MAX5X05 EV Kit Component Placement Guide—Component Side

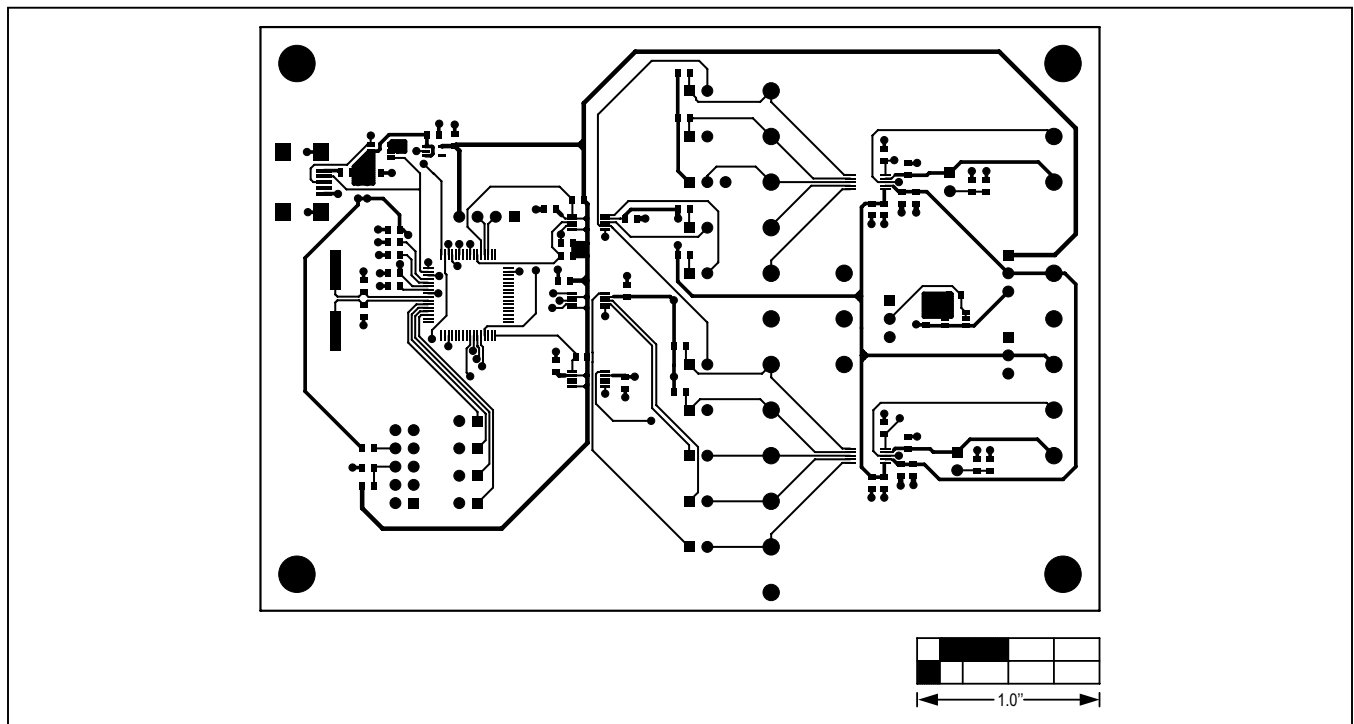

Figure 5. MAX5X05 EV Kit PCB Layout—Component Side

MAX5X05 Evaluation Kit

Evaluates: MAX5703, MAX5704,
MAX5705A, MAX5705B, MAX5803,
MAX5804, MAX5805A, MAX5805B

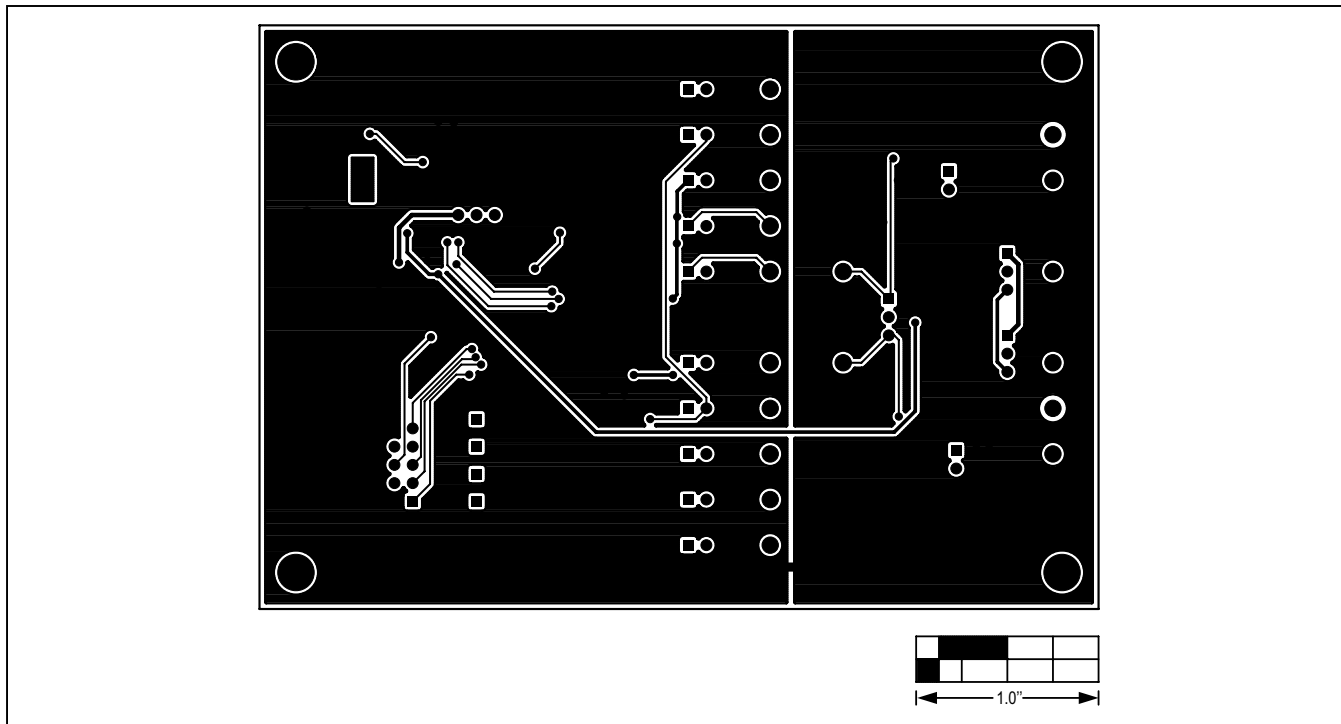

Figure 6. MAX5X05 EV Kit PCB Layout—Solder Side

MAX5X05 Evaluation Kit

Evaluates: MAX5703, MAX5704,
MAX5705A, MAX5705B, MAX5803,
MAX5804, MAX5805A, MAX5805B

Ordering Information

PART	TYPE
MAX5X05EVKIT#	EV Kit

#Denotes RoHS compliant.

MAX5X05 Evaluation Kit

Evaluates: MAX5703, MAX5704,
MAX5705A, MAX5705B, MAX5803,
MAX5804, MAX5805A, MAX5805B

Revision History

REVISION NUMBER	REVISION DATE	DESCRIPTION	PAGES CHANGED
0	1/13	Initial release	—
1	1/13	Corrected second bullet in <i>Features</i> section	1

For pricing, delivery, and ordering information, please contact Maxim Direct at 1-888-629-4642, or visit Maxim Integrated's website at www.maximintegrated.com.

Maxim Integrated cannot assume responsibility for use of any circuitry other than circuitry entirely embodied in a Maxim Integrated product. No circuit patent licenses are implied. Maxim Integrated reserves the right to change the circuitry and specifications without notice at any time.