



MAX5927 Evaluation Kit

Evaluates: MAX5927

General Description

The MAX5927 evaluation kit (EV kit) is a fully assembled and tested surface-mount quad hot-swap controller/power-sequencer/voltage-tracker circuit board, which provides current limiting and VariableSpeed/BiLevel™ fault protection on all four channels. The circuit uses the MAX5927 in a 32-pin thin QFN package and is configurable for a 1.0V to 13.2V input range. The MAX5927 features a configurable latch/autoretry fault mode, circuit-breaker function, and programmable under-voltage lockout (UVLO).

The EV kit is configured to demonstrate four separate input voltages: 5V, 3.3V, 2.5V, and 1.8V. The 5V input is configured for 0.5A of output current, while the 3.3V input is configured for 1.5A of output current. The 2.5V and 1.8V inputs are each configured for 5A of output current. The MAX5927 controls four n-channel power MOSFETs and provides current regulation during start-up for all four inputs. Several configurations allow the MAX5927's unique current regulation architecture to be tailored to the application. The current limiting and short-circuit protection features are configurable and demonstrate the various features of the MAX5927.

The EV kit has several configurations for the startup timer setting, current limit, and voltage-tracking/power-sequencing/independent modes of operation. The EV kit also provides independent turn-on delays for the four outputs, independent on/off control, and independent status reports of all four channels. The MAX5927 EV kit can also be reconfigured to emulate a MAX5929 (quad hot swap), MAX5930 (triple hot swap), or MAX5931 (triple hot swap) design.

Features

- ◆ **Input Voltages**
 - 5V, VIN1 (as Configured)
 - 3.3V, VIN2 (as Configured)
 - 2.5V, VIN3 (as Configured)
 - 1.8V, VIN4 (as Configured)
- ◆ **Configurable Voltage-Tracking/Power-Sequencing/Independent Operation Modes**
- ◆ **Independent On/Off Control and Status Reports for Each Channel**
- ◆ **Outputs**
 - VOUT1: 5V, 0.5A (Configurable for Up to 1A)
 - VOUT2: 3.3V, 1.5A (Configurable for Up to 3A)
 - VOUT3: 2.5V, 5A (Configurable for Up to 10A)
 - VOUT4: 1.8V, 5A (Configurable for Up to 10A)
- ◆ **Configurable 25mV Current-Trip Threshold**
- ◆ **Demonstrates Unique Current-Regulation Architecture and Circuit-Breaker Function**
- ◆ **Configurable Startup Timer**
- ◆ **Configurable Input Undervoltage Monitoring (All Inputs)**
- ◆ **Emulates MAX5929, MAX5930, or MAX5931 IC Functions**
- ◆ **Surface-Mount Components**
- ◆ **Fully Assembled and Tested**

Ordering Information

PART	TEMP RANGE	IC-PACKAGE
MAX5927EVKIT	0°C to +70°C	32 Thin QFN

Component Suppliers

SUPPLIER	PHONE	FAX	WEBSITE
Central Semiconductor	631-435-1110	631-435-1824	www.centalsemi.com
Fairchild	888-522-5372	N/A	www.fairchildsemi.com
IRC	361-992-7900	361-992-3377	www.irctt.com
Murata	770-436-1300	770-436-3030	www.murata.com
Sanyo USA	619-661-6322	619-661-1055	www.sanyovideo.com
Taiyo Yuden	800-348-2496	847-925-0899	www.t-yuden.com
Toshiba	949-455-2000	949-859-3963	www.toshiba.com/taec
Vishay	N/A	N/A	www.vishay.com

Note: Indicate that you are using the MAX5927 when contacting these component suppliers.

VariableSpeed/BiLevel is a trademark of Maxim Integrated Products, Inc.



For pricing, delivery, and ordering information, please contact Maxim/Dallas Direct! at 1-888-629-4642, or visit Maxim's website at www.maxim-ic.com.

MAX5927 Evaluation Kit

Evaluates: MAX5927

Component List

DESIGNATION	QTY	DESCRIPTION
C1	1	100 μ F, 16V OS-CON capacitor (E case) Sanyo 16SA100M
C2	1	150 μ F, 16V OS-CON capacitor (F case) Sanyo 16SA150M
C3, C4	2	1000 μ F, 16V OS-CON capacitors (H case) Sanyo 16SA1000M
C5–C8, C12	5	0.1 μ F \pm 10%, 25V X7R ceramic capacitors (0805) Murata GRM21BR71E104K
C9	1	0.22 μ F \pm 10%, 16V X7R ceramic capacitor (0805) Murata GRM21BR71C224K
C10	1	0.15 μ F \pm 10%, 25V X7R ceramic capacitor (0805) Murata GRM21BR71E154K
C11	1	0.068 μ F \pm 10%, 25V X7R ceramic capacitor (0805) Murata GRM219R71E683K
C13	1	1000pF \pm 10%, 50V X7R ceramic capacitor (0603) Taiyo Yuden UMK107B102KZ
C14–C17	4	1 μ F \pm 10%, 16V X7R ceramic capacitors (0805) Murata GRM21BR71C105K
C18	0	Not installed, OS-CON capacitor (E case)
C19	0	Not installed, OS-CON capacitor (F case)
C20, C21	0	Not installed, OS-CON capacitors (H case)
D1	1	1A 20V Schottky diode (SMA) Central Semiconductor CMSH1-20M

DESIGNATION	QTY	DESCRIPTION
D2, D3, D4	3	3A 30V Schottky diodes (M-Flat) Toshiba CMS02
D5	1	7.5V 500mW zener diode (SOD-123) Central Semiconductor CMHZ5236B
J1, J2	2	7-pin headers
JU1–JU4, JU6, JU7, JU9–JU12	10	2-pin headers
JU5, JU8	2	3-pin headers
N1	1	20V, 3A n-channel MOSFET (SuperSOT-3) Fairchild FDN339AN
N2	1	30V, 13A n-channel MOSFET (SO-8) Fairchild FDS6670A
N3, N4	2	30V, 100A n-channel MOSFETs (D ² PAK) Fairchild FDB7045L
R1	1	0.042 Ω \pm 1%, 0.5W sense resistor (1206) IRC LRC1206-R042-F or Vishay WSL1206R0420FSA
R2	1	0.013 Ω \pm 1%, 0.5W sense resistor (1206) IRC LRF1206-R013-F
R3, R4	2	0.0042 Ω \pm 1%, 1.5W sense resistors (2512) Vishay WSL25124L200FBA or IRC LRF2512-R004-F
R5–R8, R16, R19, R22, R25	8	100k Ω \pm 1% resistors (0805)
R9	1	4.02k Ω \pm 1% resistor (0805)
R10	1	49.9k Ω \pm 1% resistor (0805)
R11, R13, R14	3	3.32k Ω \pm 1% resistors (0805)
R12	1	1.87k Ω \pm 1% resistor (0805)
R15	1	412k Ω \pm 1% resistor (0805)
R17, R20, R23, R26	4	1k Ω \pm 5% resistors (0805)

MAX5927 Evaluation Kit

Evaluates: MAX5927

Component List (continued)

DESIGNATION	QTY	DESCRIPTION
R18	1	237k Ω \pm 1% resistor (0805)
R21	1	158k Ω \pm 1% resistor (0805)
R24	1	84.5k Ω \pm 1% resistor (0805)
R27	0	Not installed, resistor (0805)
R28, R29	2	10k Ω \pm 5% resistors (0805)
R30, R31	2	1k Ω \pm 5% resistors (0805)
R32–R35	4	5.1k Ω \pm 5% resistors (0805)
SW1–SW4	4	SPST momentary contact switches
VIN1–VIN4, VOUT1–VOUT4, PGND, PGND, PGND, PGND	12	Uninsulated banana jacks
U1	1	MAX5927ETJ (32-pin thin QFN, 5mm x 5mm)
None	12	Shunts (JU1–JU12)
None	4	Rubber bumpers

Quick Start

The MAX5927 EV kit is fully assembled and tested. Follow these steps to verify board operation. **Do not turn on the power supplies until all connections are completed.**

Required Equipment

- One 5V, 1A-capable power supply (2A for maximum current-limit configuration)
- One 3.3V, 3A-capable power supply (6A for maximum current-limit configuration)
- One 2.5V, 10A-capable power supply (20A for maximum current-limit configuration)
- One 1.8V, 10A-capable power supply (20A for maximum current-limit configuration)
- One voltmeter for confirming output voltages

MAX5927 Configuration (All Outputs)

- 1) Verify that shunts are installed on jumpers JU1 (ILIM1, 0.5A), JU2 (ILIM2, 1.5A), JU3 (ILIM3, 5A), and JU4 (ILIM4, 5A).
- 2) Verify that a shunt is installed on pins 1 and 2 of jumper JU5 (RTIM, 411 μ s).
- 3) Verify that a shunt is installed on jumper JU6 (LATCH, autoretry mode).

- 4) Verify that shunts are not installed on jumpers JU7 (POL, normal logic polarity) and JU8 (MODE, power-sequencing mode).
- 5) Verify that a shunt is installed on jumpers JU9 (ON1, C9 delay capacitor), JU10 (ON2, C10 delay capacitor), JU11 (ON3, C11 delay capacitor), and JU12 (ON4, C12 delay capacitor).
- 6) Connect the 5V power supply to the VIN1 banana jack and the supply ground to the PGND banana jack.
- 7) **Utilizing very short 10A-rated banana leads (<6in long)**, connect the 5V, 3.3V, 2.5V, and 1.8V DC power supplies to the VIN1, VIN2, VIN3, and VIN4 metal banana jacks, respectively. **Utilizing very short 10A-rated banana leads (<6in long)**, connect the supply grounds to the respective PGND metal banana jacks.
- 8) Connect the voltmeter to the VOUT1 and PGND pads.
- 9) Turn on all four power supplies and verify the following output voltages:

VOUT1 = 5V

VOUT2 = 3.3V

VOUT3 = 2.5V

VOUT4 = 1.8V

- 10) Pressing pushbutton switches SW1–SW4 resets their respective outputs (VOUT1–VOUT4).
- 11) Test points TP1–TP4 and GND pads nearby are provided to observe their respective MOSFET gate voltages with an oscilloscope.

Note: The banana leads connecting the power supplies and their respective load to the EV kit must be very short (<6in long) and rated for at least 10A of current.

Detailed Description

The MAX5927 EV kit is a quad hot-swap controller circuit board configured to four different input voltages: 5V input (VIN1), 3.3V input (VIN2), 2.5V input (VIN3), and 1.8V input (VIN4). All four inputs have separate and independent current limiting, VariableSpeed/BiLevel fault protection, and circuit-breaker functions. The EV kit uses a MAX5927ETJ IC in a 32-pin thin QFN package to control the four channels of the circuit. The EV kit can be reconfigured for any input voltage between 1.0V and 13.2V, given that at least one input voltage is \geq 2.7V.

The EV kit features several modes of operation that are jumper configurable (JU8): voltage-tracking mode, power-sequencing mode, and independent mode. In the voltage-tracking mode, the MAX5927 turns all channels on and off together. When the EV kit is configured for the power-sequencing mode, the MAX5927

MAX5927 Evaluation Kit

turns each channel on and off depending on the corresponding ON pin command voltage. In this mode, all channels are turned off if a fault occurs on any channel. Lastly, the independent mode provides separate control of each channel. When a fault occurs in this mode of operation, the MAX5927 only shuts down the affected channel. Pushbutton switches SW1–SW4 are provided for resetting the outputs VOUT1–VOUT4, respectively.

The EV kit has configurable startup timer settings. Jumper-configurable (JU9–JU12) independent power turn-on delay capacitors at each ON pin input (C9–C12) provide several choices for evaluating different hot-swap methods. The MAX5927's ON pin signals and open-drain STAT pin signals are provided at headers J1 and J2 for all channels on the EV kit. The 0.100in center headers can be connected with a ribbon cable to facilitate evaluation. The STAT pin's logic polarity can be reversed using JU7 to configure the MAX5927 POL pin. The EV kit also features a configurable latch/autoretry fault mode. JU6 configures the EV kit for the desired fault mode. In the latched mode, the outputs are latched off until all the power supplies have been cycled off and then on.

Additionally, the pushbutton switch for the respective channel that caused the fault can be pushed to unlatch the outputs. In the autoretry mode, the MAX5927 attempts to turn the outputs back on after a delay period.

The MAX5927 controls each channel's power n-channel MOSFET (N1–N4) and provides current regulation during startup for all four channels' outputs. The current-limit threshold level can be reconfigured separately for each channel's output.

The 5V output (VOUT1) current limit can be configured for 1A by using JU1. PC board pads are provided for external capacitor C5 to increase MOSFET N1's gate turn-on time. Test point TP1 can be used with an oscilloscope to view N1's gate voltage. PC board pads are also provided for an optional user-installed surface-mount zener diode (SOD-123 case, D5) to clamp N1's gate-source voltage.

The 3.3V output (VOUT2) current limit can be configured for 3A by using JU2. PC board pads are provided for external capacitor C6 to increase MOSFET N2's gate turn-on time. Test point TP2 can be used with an oscilloscope to view N2's gate voltage.

The 2.5V output (VOUT3) current limit can be configured for 10A by using JU3. PC board pads are provided for external capacitor C7 to increase MOSFET N3's gate turn-on time. Test point TP3 can be used with an oscilloscope to view N3's gate voltage.

The 1.8V output (VOUT4) current limit can be configured for 10A by using JU4. PC board pads are provided for external capacitor C8 to increase MOSFET N4's gate turn-on time. Additionally, pads are also provided for an optional user-installed surface-mount resistor (0805 case, R33) to help control gate oscillations on N4 or to disable it. Test point TP4 can be used with an oscilloscope to view N4's gate voltage.

Additionally, the MAX5927 EV kit can be used to evaluate outputs up to 20A. When configuring for higher current levels, install optional capacitors C18–C21. These capacitors are provided with the EV kit. Several resistors and MOSFETs must be appropriately chosen for the higher current levels. See the *Evaluating Other Input Voltages (1V to 13.2V) and Other Output Currents* section for more details. Diodes D1–D4 on the EV kit are used to prevent an inductive kickback resulting from long lead connections in a lab environment. They are generally not needed in a real application circuit.

The MAX5927 EV kit can also be used to emulate the MAX5929 quad hot-swap design or the MAX5930/MAX5931 triple hot-swap design after reconfiguring the appropriate jumpers and/or component replacement. See the *MAX5929/MAX5930/MAX5931 Emulation* section for information on emulating other hot-swap designs.

MAX5927 Evaluation Kit

Evaluates: MAX5927

Jumper Selection

Several jumper selections in the following tables display the functions and emulation modes provided by the MAX5927 EV kit.

5V Slow Comparator Current Limit (VOUT1)

The MAX5927 EV kit features a 2-pin jumper (JU1) to change the slow comparator current-limit threshold level for the 5V output. Table 1 lists the jumper options.

3.3V Slow Comparator Current Limit (VOUT2)

The MAX5927 EV kit features a 2-pin jumper (JU2) to change the slow comparator current-limit threshold level for the 3.3V output. Table 2 lists the jumper options.

Table 1. Jumper JU1 Functions

SHUNT LOCATION	ILIM1 PIN	EV KIT MODE
Installed	Connected to GND	VOUT1 slow comparator current limit set to 25mV
None	Connected to resistor R11	VOUT1 slow comparator current limit set to 50mV

Table 2. Jumper JU2 Functions

SHUNT LOCATION	ILIM2 PIN	EV KIT MODE
Installed	Connected to GND	VOUT2 slow comparator current limit set to 25mV
None	Connected to resistor R12	VOUT2 slow comparator current limit set to 39mV

2.5V Slow Comparator Current Limit (VOUT3)

The MAX5927 EV kit features a 2-pin jumper (JU3) to change the slow comparator current-limit threshold level for the 2.5V output. Table 3 lists the jumper options.

1.8V Slow Comparator Current Limit (VOUT4)

The MAX5927 EV kit features a 2-pin jumper (JU4) to change the slow comparator current-limit threshold level for the 1.8V output. Table 4 lists the jumper options.

Table 3. Jumper JU3 Functions

SHUNT LOCATION	ILIM3 PIN	EV KIT MODE
Installed	Connected to GND	VOUT3 slow comparator current limit set to 25mV
None	Connected to resistor R13	VOUT3 slow comparator current limit set to 50mV

Table 4. Jumper JU4 Functions

SHUNT LOCATION	ILIM4 PIN	EV KIT MODE
Installed	Connected to GND	VOUT4 slow comparator current limit set to 25mV
None	Connected to resistor R14	VOUT4 slow comparator current limit set to 50mV

MAX5927 Evaluation Kit

Startup Timer Setting

The MAX5927 EV kit features several choices for setting the time limit to completely turn on power MOSFETs N1–N4. Jumper JU5 selects the time and Table 5 lists the selectable jumper options to reconfigure the startup timer setting.

Latch/Autoretry Fault Modes

The MAX5927 EV kit features a jumper to configure the EV kit mode of operation after a fault has occurred, to either latched or autoretry mode. Jumper JU6 sets the latch/autoretry mode of the LATCH pin on the MAX5927. Table 6 lists the selectable jumper options.

Table 5. Jumper JU5 Functions

SHUNT LOCATION	RTIM PIN	EV KIT MODE
1 and 2	Connected to R9	411 μ s startup timer setting
2 and 3	Connected to R10	5.1ms startup timer setting
None	Floating	9ms startup timer setting

Table 6. Jumper JU6 Functions

SHUNT LOCATION	LATCH PIN	EV KIT MODE
None	Floating	Latched mode
Installed	Connected to GND	Autoretry mode

Status Output Polarity

The MAX5927 EV kit features a jumper to configure the MAX5927 status pin's logic polarity.

The status pin normally provides a logic high when a hot swap has been successful and a logic low for a fault condition. The status pin's logic polarity or state can be reversed with jumper JU7. JU7 sets the polarity of the status outputs on the MAX5927 EV kit. Table 7 lists the selectable jumper options.

Voltage-Tracking/Power-Sequencing/Independent Operation Modes

The MAX5927 EV kit features several choices for setting the EV kit's operating mode; voltage-tracking mode, power-sequencing mode, or independent mode control of each channel. Jumper JU8 selects the operating mode and Table 8 lists the selectable jumper options to reconfigure the operating mode.

Table 7. Jumper JU7 Functions

SHUNT LOCATION	POL PIN	STAT1–STAT4 PIN MODE
None	Floating	Normal logic polarity (asserted open drain)
Installed	Connected to GND	Reverse logic polarity (asserted low)

Table 8. Jumper JU8 Functions

SHUNT LOCATION	MODE PIN	EV KIT OPERATION
1 and 2	Connected to VBIAS	Voltage-tracking mode
2 and 3	Connected to GND	Independent mode
None	Floating	Power-sequencing mode

See the Detailed Description section for more information on the various types of operating modes.

MAX5927 Evaluation Kit

Evaluates: MAX5927

ON1 Pin Delay (VIN1)

The MAX5927 EV kit features a jumper to delay turning on the VOUT1 output. Given that at least one input is $\geq 2.7V$ for more than the UVLO-to-startup delay (37.5ms, typ), the jumper sets the response of the MAX5927 ON1 pin with respect to VIN1. Jumper JU9 selects the turn-on delay for the EV kit. Table 9 lists the selectable jumper options.

ON2 Pin Delay (VIN2)

The MAX5927 EV kit features a jumper to delay turning on the VOUT2 output. Given that at least one input is $\geq 2.7V$ for more than the UVLO-to-startup delay (37.5ms, typ), the jumper sets the response of the MAX5927 ON2 pin with respect to VIN2. Jumper JU10 selects the turn-on delay for the EV kit. Table 10 lists the selectable jumper options.

ON3 Pin Delay (VIN3)

The MAX5927 EV kit features a jumper to delay turning on the VOUT3 output. Given that at least one input is $\geq 2.7V$ for more than the UVLO-to-startup delay (37.5ms, typ), the jumper sets the response of the MAX5927 ON3 pin with respect to VIN3. Jumper JU11 selects the turn-on delay for the EV kit. Table 11 lists the selectable jumper options.

ON4 Pin Delay (VIN4)

The MAX5927 EV kit features a jumper to delay turning on the VOUT4 output. Given that at least one input is $\geq 2.7V$ for more than the UVLO-to-startup delay (37.5ms, typ), the jumper sets the response of the MAX5927 ON4 pin with respect to VIN4. Jumper JU12 selects the turn-on delay for the EV kit. Table 12 lists the selectable jumper options.

Table 9. Jumper JU9 Functions

SHUNT LOCATION	ON1 PIN, R15, R16	EV KIT MODE
None	C9 floating	VOUT1 turns on with no delay
Installed	Connected to C9; enable turn-on delay	VOUT1 turns on 40.1ms after releasing SW1

Table 10. Jumper JU10 Functions

SHUNT LOCATION	ON2 PIN, R18, R19	EV KIT MODE
None	C10 floating	VOUT2 turns on with no delay
Installed	Connected to C10; enable turn-on delay	VOUT2 turns on 20.6ms after releasing SW2

Table 11. Jumper JU11 Functions

SHUNT LOCATION	ON3 PIN, R21, R22	EV KIT MODE
None	C11 floating	VOUT3 turns on with no delay
Installed	Connected to C11; enable turn-on delay	VOUT3 turns on 10ms after releasing SW3

Table 12. Jumper JU12 Functions

SHUNT LOCATION	ON4 PIN, R24, R25	EV KIT MODE
None	C12 floating	VOUT4 turns on with no delay
Installed	Connected to C12; enable turn-on delay	VOUT4 turns on 9.7ms after releasing SW4

MAX5927 Evaluation Kit

J1 and J2 Header Signals

The MAX5927 EV kit features two 7-pin 0.100in center headers for monitoring the STAT_ and ON_ signal of each channel. Header J1 provides the signals for channels 1 and 4, while header J2 provides the signals for channels 2 and 3. Analog grounds are provided at each header. Table 13 lists the specific header pin signals.

Control Modes and Other Input Voltages

Fault Resetting and ON Pins

The MAX5927 EV kit features four pushbutton switches (SW1–SW4) to allow momentary toggling of the ON1–ON4 pins of the MAX5927. Each switch disables the respective EV kit output or unlatches faults when the EV kit is configured for latch mode (see Table 6). A voltage can also be applied to the respective ON pin of headers J1 or J2 (see Table 13) to perform other functions with the MAX5927 ON pin. Refer to the MAX5927/MAX5929 data sheet for additional functions of the ON pins when toggling or applying a voltage to the pins.

MOSFET Gate Control

The MAX5927 EV kit features an option to increase a channel's power MOSFET gate (N1–N4) turn-on time. PC board pads are provided for installing a 0805 surface-mount capacitor (C5–C8) at the respective gate-drive pin. Refer to the MAX5927/MAX5929 data sheet for information on selecting the value of the capacitors. Test points TP1–TP4 are provided to observe the respective gate-drive voltage with an oscilloscope. Zener diode D5 is used to clamp the gate-to-source voltage of MOSFET N1 during an output short-circuit condition.

Table 13. Header J1 and J2 Pin Signals

HEADER J1 PIN	SIGNAL	HEADER J2 PIN	SIGNAL
1	STAT1	1	STAT2
2	GND	2	GND
3	ON_1	3	ON_2
4	GND	4	GND
5	STAT4	5	STAT3
6	GND	6	GND
7	ON_4	7	ON_3

Evaluating Other Input Voltages (1V to 13.2V) and Other Output Currents

The MAX5927 EV kit can evaluate other quad hot-swap controller configuration voltages operating from 1V to 13.2V and provide up to 20A of current at the output. One of the input voltages, VIN1–VIN4, must be $\geq 2.7V$. To evaluate other current limits, current-sense resistors R1–R4, current-limit resistors R11–R14, and MOSFETs N1–N4 must be appropriately chosen for the new current and/or voltage level at the modified channel. Refer to the MAX5927/MAX5929 data sheet for information on selecting components.

MAX5929/MAX5930/MAX5931 Emulation

Emulating a MAX5929 Quad Hot-Swap or MAX5930/MAX5931 Triple Hot-Swap Design

The MAX5927 EV kit can emulate the MAX5929, MAX5930, or MAX5931 hot-swap features. The EV kit uses the MAX5927 and properly set jumpers to emulate other designs. See Table 14 to emulate the MAX5929 design, or Table 15 to emulate the MAX5930 design, or Table 16 to emulate the MAX5931 design. The triple hot-swap emulation requires component removal and installation. Refer to the MAX5927/MAX5929 data sheet for a description of specific pin functions on the emulated Maxim part and its associated external components.

MAX5927 Evaluation Kit

Evaluates: MAX5927

Table 14. Emulating a MAX5929 Quad Hot-Swap Design (Set Shunt Location per Table)

JUMPER	SHUNT LOCATION	MAX5929 PIN	MAX5929 EV KIT MODE EMULATED
JU1	Installed	ILIM1	VOUT1 slow comparator current limit set to 25mV; fixed at 25mV on the MAX5929
JU2	Installed	ILIM2	VOUT2 slow comparator current limit set to 25mV; fixed at 25mV on the MAX5929
JU3	Installed	ILIM3	VOUT3 slow comparator current limit set to 25mV; fixed at 25mV on the MAX5929
JU4	Installed	ILIM4	VOUT4 slow comparator current limit set to 25mV; fixed at 25mV on the MAX5929
JU5	Set per Table 5	RTIM	Startup timer setting delay
JU6	Set per Table 6 and MAX5929 IC desired	LATCH	Latched or autoretry mode
JU7	Set per Table 7 and MAX5929 IC desired	POL	Status output pins logic polarity
JU8	Set per Table 8	MODE	Voltage-tracking/power-sequencing/independent operation mode
JU9	Set per Table 9	ON1	VOUT1 turn-on delay setting
JU10	Set per Table 10	ON2	VOUT2 turn-on delay setting
JU11	Set per Table 11	ON3	VOUT3 turn-on delay setting
JU12	Set per Table 12	ON4	VOUT4 turn-on delay setting

To evaluate a triple hot-swap design, channel 4 of the MAX5927 EV kit must be disabled. Perform the following modifications prior to reconfiguring the jumpers:

- 1) Remove surface-mount resistors R24, R25, and R26.
- 2) Install a 1k Ω , 0805 surface-mount resistor at R27.
- 3) Confirm that header J1/pin 7 (ON_4) does not have an external voltage source applied to it.

4) Connect a jumper from the VIN3 input to the VIN4 input.

5) To evaluate a quad hot-swap design again, reverse the above steps.

MAX5927 Evaluation Kit

Table 15. Emulating a MAX5930 Triple Hot-Swap Design (Set Shunt Location per Table)

JUMPER	SHUNT LOCATION	MAX5930 PIN	MAX5930 EV KIT MODE EMULATED
JU1	Set per Table 1	ILIM1	VOUT1 slow comparator current limit
JU2	Set per Table 2	ILIM2	VOUT2 slow comparator current limit
JU3	Set per Table 3	ILIM3	VOUT3 slow comparator current limit
JU4	Installed	ILIM4	MAX5930 does not have this pin
JU5	Set per Table 5	RTIM	Startup timer setting delay
JU6	Set per Table 6	LATCH	Latched or autoretry mode
JU7	Set per Table 7	POL	Status output pins logic polarity
JU8	Set per Table 8	MODE	Voltage-tracking/power-sequencing/independent operation mode
JU9	Set per Table 9	ON1	VOUT1 turn-on delay setting
JU10	Set per Table 10	ON2	VOUT2 turn-on delay setting
JU11	Set per Table 11	ON3	VOUT3 turn-on delay setting
JU12	None	ON4	MAX5930 does not have this pin

To evaluate a triple hot-swap design, channel 4 of the MAX5927 EV kit must be disabled. Perform the following modifications prior to reconfiguring the jumpers:

- 1) Remove surface-mount resistors R24, R25, and R26.
- 2) Install a 1k Ω , 0805 surface-mount resistor at R27.

- 3) Confirm that header J1/pin 7 (ON_4) does not have an external voltage source applied to it.
- 4) Connect a jumper from the VIN3 input to the VIN4 input.
- 5) To evaluate a quad hot-swap design again, reverse the above steps.

Table 16. Emulating a MAX5931 Triple Hot-Swap Design (Set Shunt Location per Table)

JUMPER	SHUNT LOCATION	MAX5931 PIN	MAX5931 EV KIT MODE EMULATED
JU1	Installed	ILIM1	VOUT1 slow comparator current limit set to 25mV; fixed at 25mV on the MAX5931
JU2	Installed	ILIM2	VOUT2 slow comparator current limit set to 25mV; fixed at 25mV on the MAX5931
JU3	Installed	ILIM3	VOUT3 slow comparator current limit set to 25mV; fixed at 25mV on the MAX5931
JU4	Installed	ILIM4	MAX5931 does not have this pin
JU5	Set per Table 5	RTIM	Startup timer setting delay
JU6	Set per Table 6 and MAX5931 IC desired	LATCH	Latched or autoretry mode
JU7	Set per Table 7 and MAX5931 IC desired	POL	Status output pins logic polarity
JU8	Set per Table 8	MODE	Voltage-tracking/power-sequencing/independent operation mode
JU9	Set per Table 9	ON1	VOUT1 turn-on delay setting
JU10	Set per Table 10	ON2	VOUT2 turn-on delay setting
JU11	Set per Table 11	ON3	VOUT3 turn-on delay setting
JU12	None	ON4	MAX5930 does not have this pin

MAX5927 Evaluation Kit

Evaluates: MAX5927

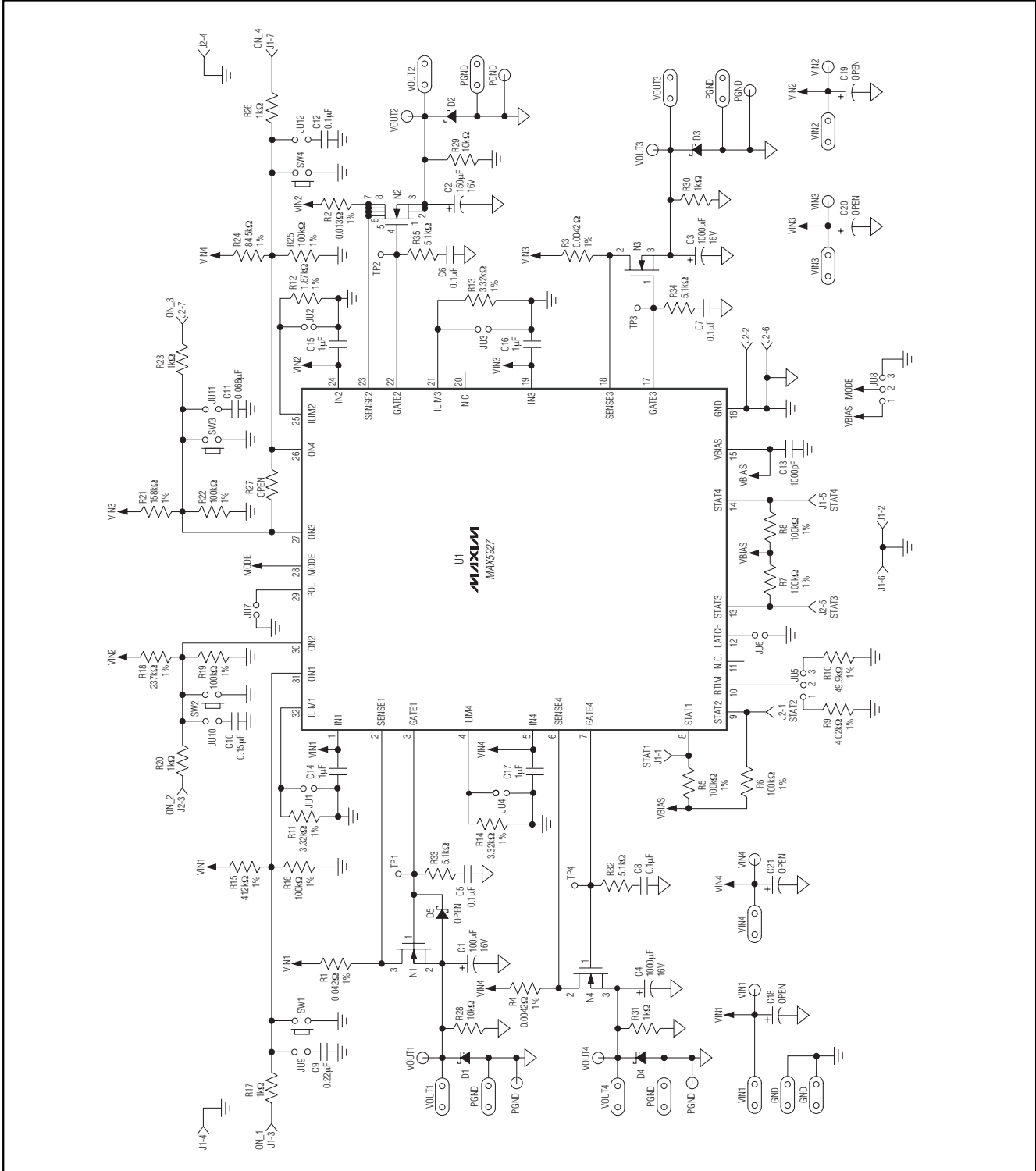

Figure 1. MAX5927 EV Kit Schematic

MAX5927 Evaluation Kit

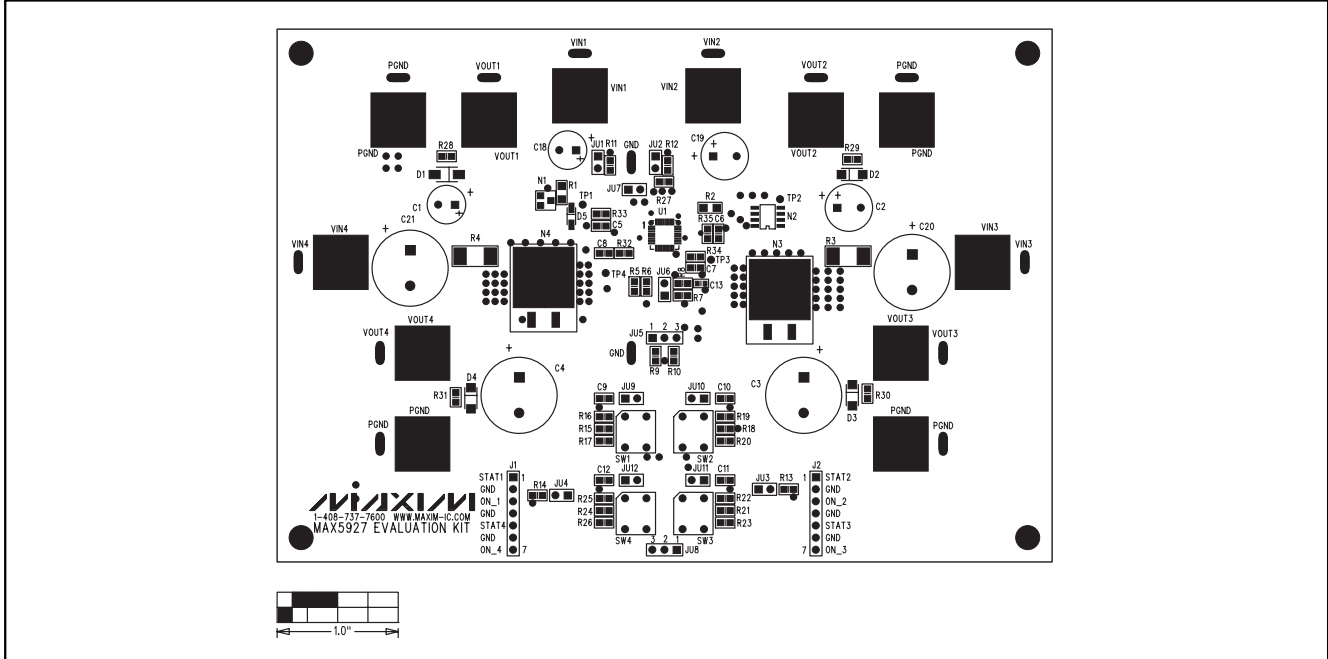

Figure 2. MAX5927 EV Kit Component Placement Guide—Component Side

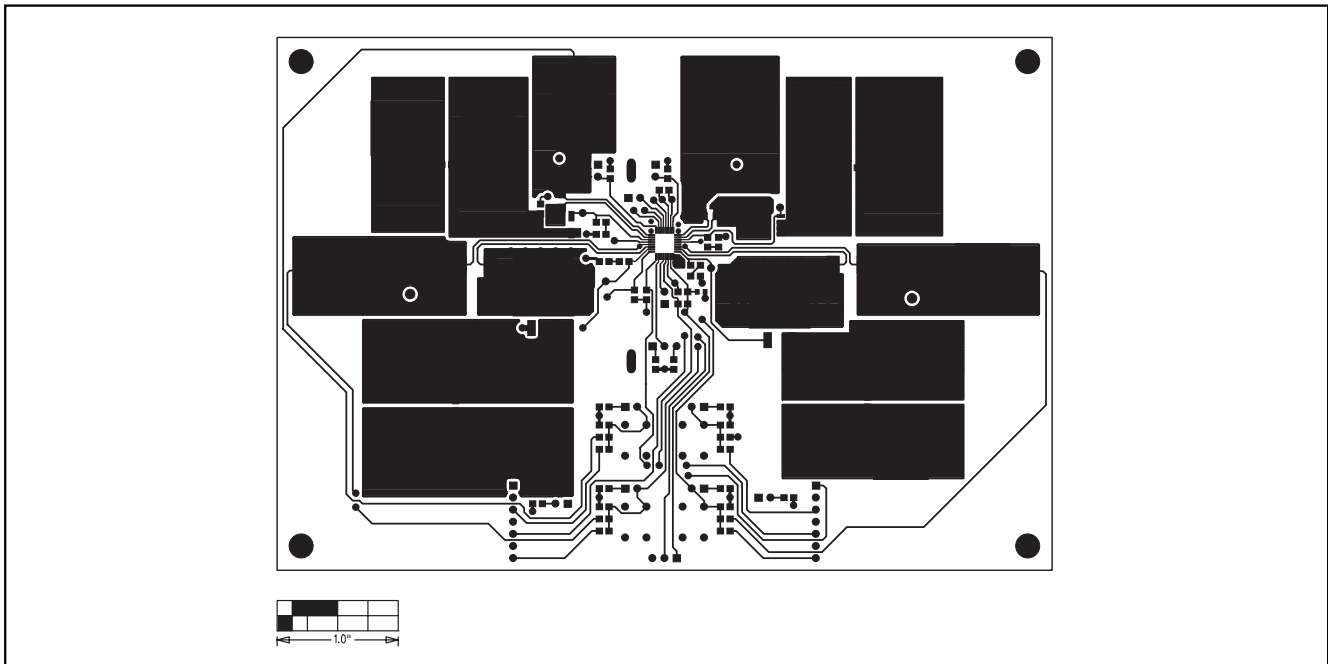

Figure 3. MAX5927 EV Kit PC Board Layout—Component Side

MAX5927 Evaluation Kit

Evaluates: MAX5927

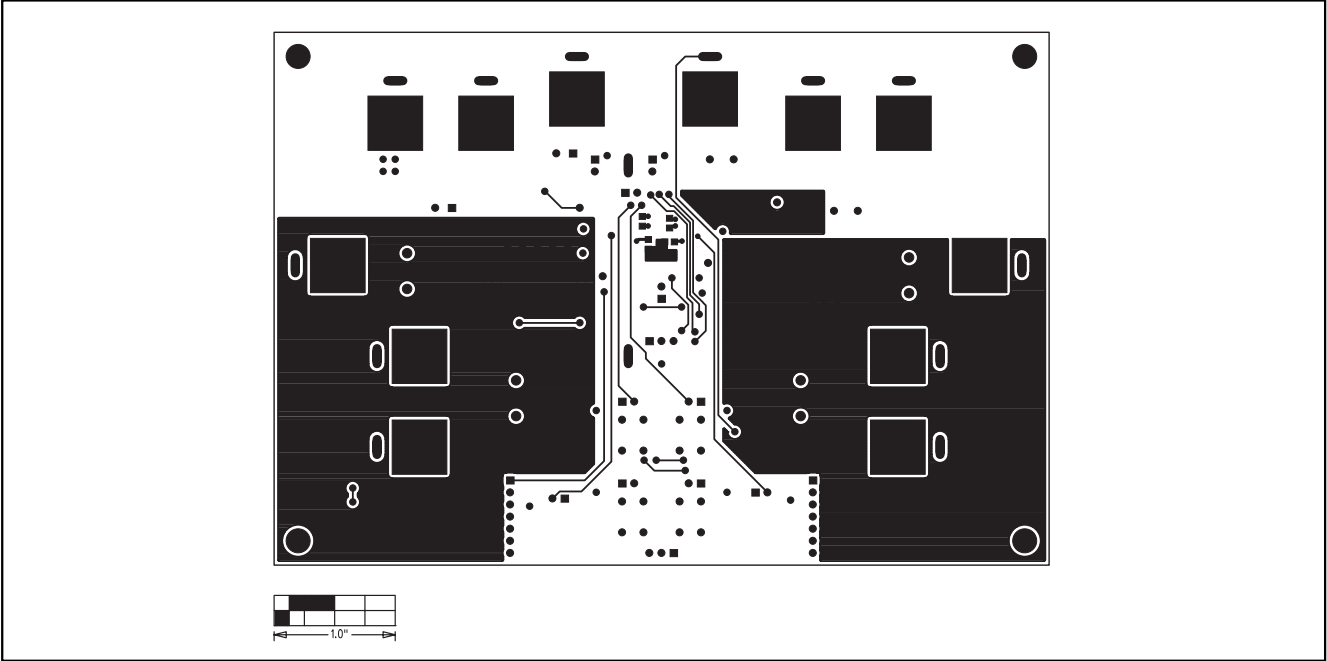

Figure 4. MAX5927 EV Kit PC Board Layout—Solder Side

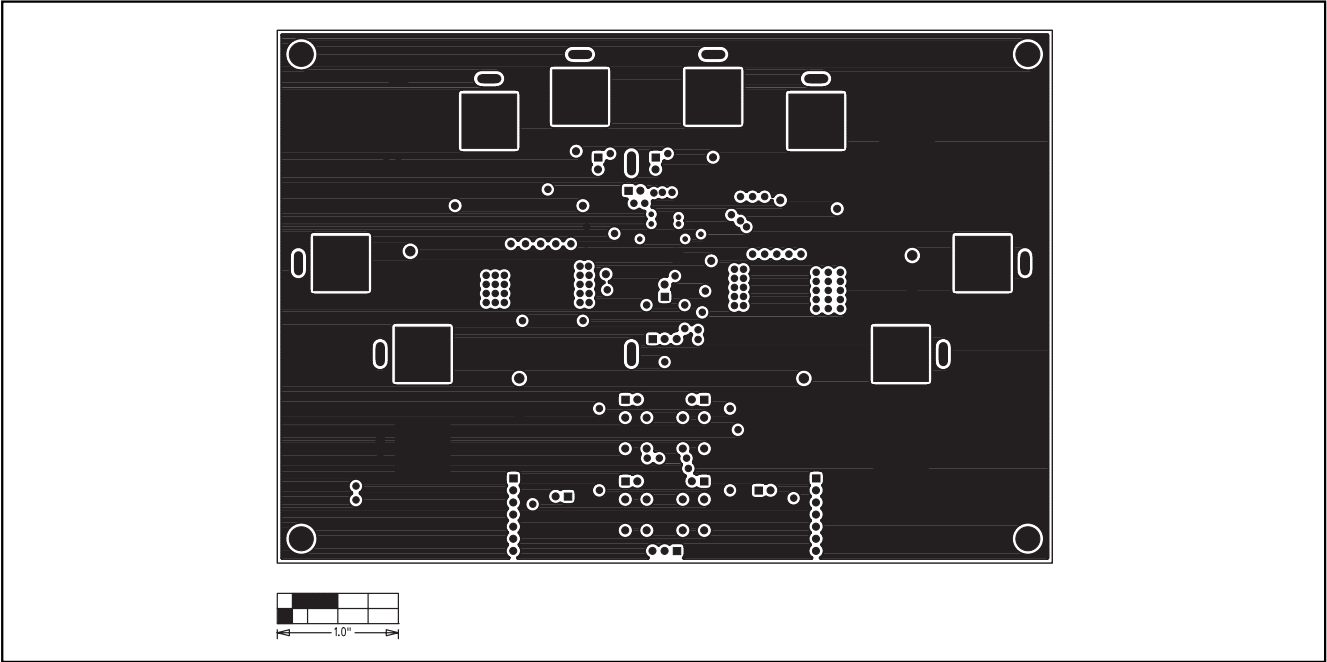

Figure 5. MAX5927 EV Kit PC Board Layout—PGND Layer 2

MAX5927 Evaluation Kit

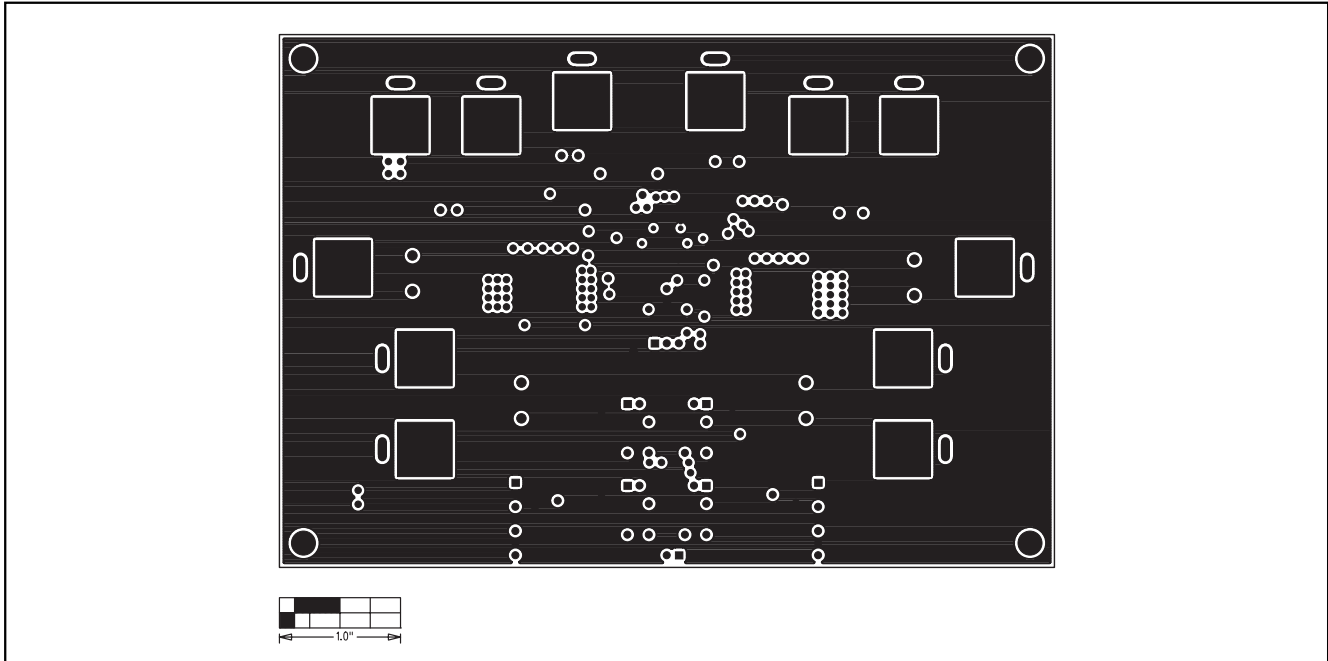

Figure 6. MAX5927 EV Kit PC Board Layout—GND Layer 3

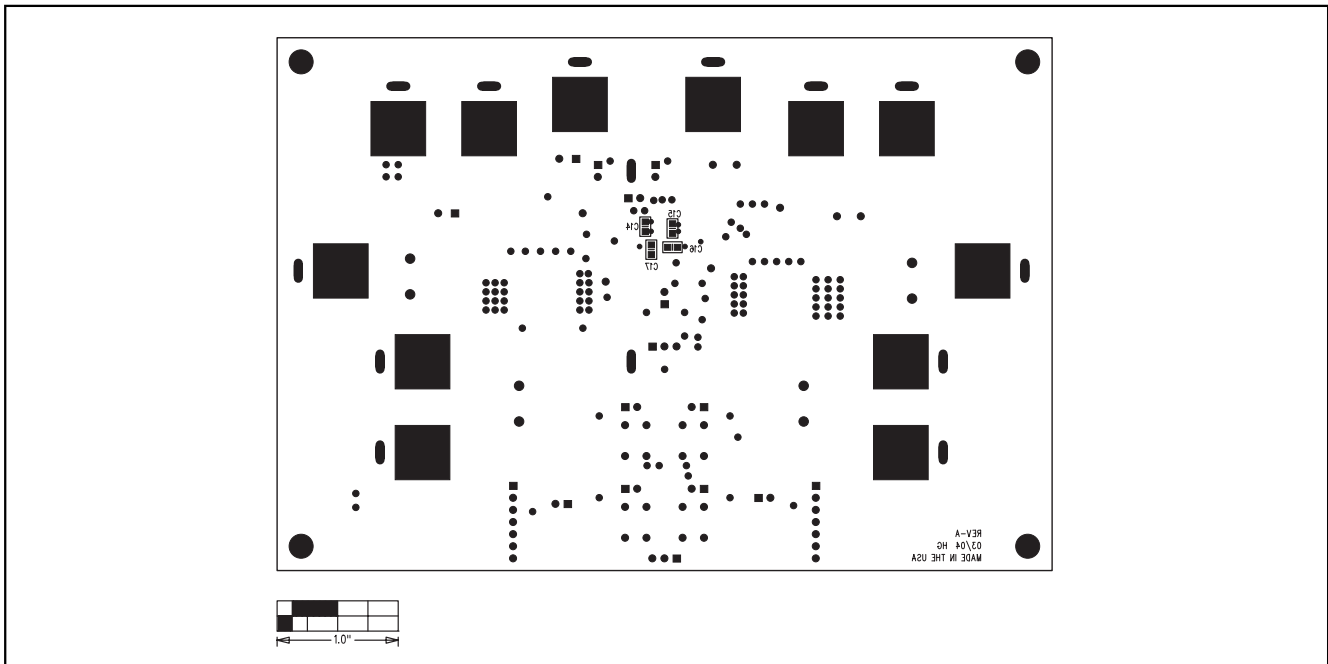

Figure 7. MAX5927 EV Kit Component Placement Guide—Solder Side

Maxim cannot assume responsibility for use of any circuitry other than circuitry entirely embodied in a Maxim product. No circuit patent licenses are implied. Maxim reserves the right to change the circuitry and specifications without notice at any time.

14 _____ **Maxim Integrated Products, 120 San Gabriel Drive, Sunnyvale, CA 94086 408-737-7600**