

MAX25222

Automotive 4-Channel TFT-LCD Power Supply with VCOM Buffer and ASIL B Features

General Description

The MAX25222 is a 4-channel TFT-LCD power IC that provides symmetrical positive AVDD and negative NAVDD supplies as well as VG_{ON} and VG_{OFF} gate supplies. In addition, a VCOM buffer with output voltage range above and below ground and a temperature measurement block are integrated.

The device contains non-volatile memory so that the values of all outputs can be calibrated for the lifetime of the device (maximum five times).

Programming is carried out using the built-in I²C interface, which can also be used to read back diagnostic information. A stand-alone mode is available after the device has been programmed.

The temperature sensor interface block measures the temperature optionally allowing the VCOM output voltage to be adjusted depending on the measured temperature.

The MAX25222 includes extensive diagnostics to aid in fulfilling ASIL-B safety level.

The MAX25222 is available in a TQFN package and operates in the -40 to 125°C temperature range.

Applications

- Infotainment Displays
- Central Information Displays
- Instrument Clusters

Benefits and Features

- High Integration
 - Synchronous Boost Provides AVDD of 4.2V to 10.5V at up to 200mA
 - NAVDD Inverter Output at up to -200mA
 - 15mA VG_{ON} Output (7.6V to 20.2V) from 3x Regulated Charge Pump
 - VG_{OFF} (-18.2V to -5.6V) from Regulated Charge Pump at up to -15mA (Charge-Pump Doubler)
 - Controlled Sequencing during Power-On and Power-Off of All Rails
 - VCOM Output Range +1V to -2.49V in 6.83mV Steps
 - NTC Input for Temperature Measurement/ Compensation
- Low EMI
 - 420kHz/2.1MHz Switching Frequency with Spread Spectrum
- I²C Control/Diagnostic Interface with FLTB (Interrupt) Output
 - UV diagnostics on All Outputs
 - OV diagnostics on All Outputs
 - Bandgap Reference Out of Range
 - Stuck FLTB pin
 - Communication Parity Check
 - VCOM DAC Fault
- Versatile
 - Non-Volatile Output Voltage Settings on AVDD/ NAVDD, VG_{ON}, VG_{OFF}, VCOM, and Sequencing
 - Supports Stand-Alone Operation Mode after Programming
 - Compact 5mm x 5mm TQFN32 Package
- AECQ100 Grade 1

Ordering Information appears at end of datasheet.

Simplified Block Diagram

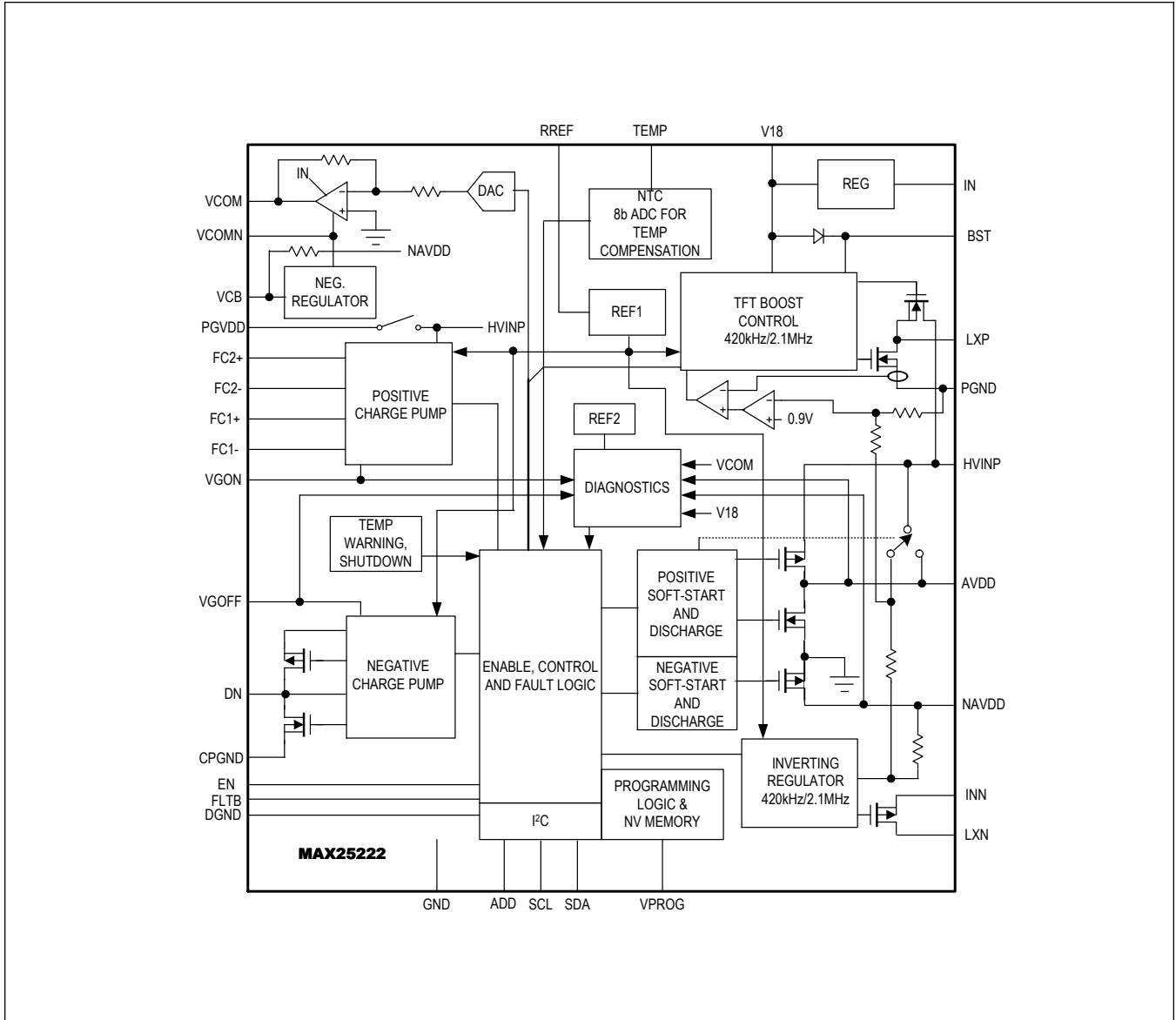

TABLE OF CONTENTS

General Description	1
Applications	1
Benefits and Features	1
Simplified Block Diagram	2
Absolute Maximum Ratings	7
Package Information	7
TQFN	7
TQFN-SW	7
Electrical Characteristics	8
Typical Operating Characteristics	14
Pin Configuration	16
MAX25222	16
Pin Description	16
Functional Diagrams	18
MAX25222	18
Detailed Description	19
Power-Up state	19
Switching Frequency	19
Stand-Alone Operation	19
Source Driver Power Supplies	19
Gate-Driver Power Supplies	20
Sequencing	20
Sequencing Diagram	21
VCOM Buffer	21
VCOMN Negative Power Supply	22
Limiting the Range of VCOM Voltage	22
VCOM Temperature Compensation	22
NTC Connection Diagram	23
Internal Temperature Sensor	23
Temperature Compensation Curve	23
Fault Handling	24
Undervoltage Faults on the Source, Gate and VCOM Outputs	24
Overvoltage Faults on the Source and Gate Outputs	24
Further Faults	24
Thermal Warning and Shutdown	25
NV Memory	25
Auto-Refresh Function	25
BURN, REBOOT and RESTART Commands	25

TABLE OF CONTENTS (CONTINUED)

I ² C Interface	25
I ² C Slave Addresses	26
Parity Checking	26
Register Map	27
MAX25222	27
Register Details	28
Applications Information	45
Boost Converter	45
Boost Converter Inductor Selection	45
Boost Output Filter Capacitor Selection	45
Boost Input Filter Capacitor	45
Setting the AVDD Voltage	45
NAVDD Inverting Regulator	45
NAVDD Regulator Inductor Selection	46
NAVDD External Diode Selection	46
NAVDD Output Capacitor Selection	46
Setting the V _{GON} and V _{GOFF} Output Voltages	46
VCOM Block	46
VCB Transistor	46
VCOM Temperature Compensation Example	46
Sample VCOM Temperature Compensation Curve	48
Using the NV Memory	48
Layout Considerations	49
Typical Application Circuits	50
Applications Diagram	50
Ordering Information	51
Revision History	52

LIST OF FIGURES

Figure 1. Sequencing Example (Sequence 1, Not to Scale).....	21
Figure 2. Possible NTC Connection	23
Figure 3. Temperature Compensation Curve	23
Figure 4. Sample VCOM Temperature Compensation Curve.....	48

LIST OF TABLES

Table 1. Available Sequences	20
Table 2. VCOM Settings	21
Table 3. FLTB Duty Cycle in Stand-Alone Mode	24
Table 4. I ² C Slave Addresses	26
Table 5. ADC Result vs Temperature	47
Table 6. VCOM Setting Example	47

Absolute Maximum Ratings

IN, INN to GND.....	-0.3V to +6V	VCOMN to GND.....	V18 - 6V to V18 + 0.3V
IN to INN.....	-0.3V to +0.3V	PGVDD, FC1-, FC2-, DN to GND.....	-0.3V to HVINP + 0.3V
V18 to GND.....	-0.3V to +2.2V	FC1+ to GND.....	-0.3V to PGVDD + 0.3V
HVINP to GND.....	-0.3V to 16V	FC2+ TO FC1+.....	-0.3V to +22V
LXP, AVDD to GND.....	-0.3V to HVINP + 0.3V	VG _{ON} to FC2+.....	-0.3V to +22V
BST to GND.....	-0.3V to +16V	FC2+, VG _{ON} to GND.....	-0.3V to +24V
BST to LXP.....	-0.3V to +2.2V	EN, FLTB, SCL, SDA to GND.....	-0.3V to +6V
LXN to INN.....	-22V to +0.3V	ADD, TEMP, R _{REF} to GND.....	-0.3V to V18 + 0.3V
PGND, CPGND, DGND to GND.....	-0.3V to +0.3V	V _{PROG} to GND.....	-0.3V to +14V
VCB to GND.....	V18 - 22V to V18 + 0.3V	Continuous Power Dissipation (Multilayer Board) (T _A = +70°C, derate 21.3mW/°C above +70°C).....	2222mW
VG _{OFF} , NAVDD to GND.....	IN - 22V to IN + 0.3V	Operating Temperature Range.....	-40°C to 125°C
VCOM to GND.....	VCOMN - 0.3V to IN + 0.3V		

Stresses beyond those listed under "Absolute Maximum Ratings" may cause permanent damage to the device. These are stress ratings only, and functional operation of the device at these or any other conditions beyond those indicated in the operational sections of the specifications is not implied. Exposure to absolute maximum rating conditions for extended periods may affect device reliability.

Package Information

TQFN

Package Code	T3255+6C
Outline Number	21-0140
Land Pattern Number	90-0603
Thermal Resistance, Single-Layer Board:	
Junction to Ambient (θ _{JA})	47°C/W
Junction to Case (θ _{JC})	3°C/W
Thermal Resistance, Four-Layer Board:	
Junction to Ambient (θ _{JA})	36°C/W
Junction to Case (θ _{JC})	3°C/W

TQFN-SW

Package Code	T3255Y+6C
Outline Number	21-100041
Land Pattern Number	90-100066
Thermal Resistance, Single-Layer Board:	
Junction to Ambient (θ _{JA})	47°C/W
Junction to Case (θ _{JC})	3°C/W
Thermal Resistance, Four-Layer Board:	
Junction to Ambient (θ _{JA})	36°C/W
Junction to Case (θ _{JC})	3°C/W

For the latest package outline information and land patterns (footprints), go to www.maximintegrated.com/packages. Note that a "+", "#", or "-" in the package code indicates RoHS status only. Package drawings may show a different suffix character, but the drawing pertains to the package regardless of RoHS status.

Package thermal resistances were obtained using the method described in JEDEC specification JESD51-7, using a four-layer board. For detailed information on package thermal considerations, refer to www.maximintegrated.com/thermal-tutorial.

Electrical Characteristics

($V_{IN} = 3.3V$, $V_{INN} = 3.3V$, Limits are 100% guaranteed between $T_A = -40^\circ C$ and $T_A = +125^\circ C$.)

PARAMETER	SYMBOL	CONDITIONS	MIN	TYP	MAX	UNITS
INPUT SUPPLY						
IN Voltage Range			2.65		5.5	V
IN UVLO Threshold	IN_UVLO_R	Rising	2.4	2.5	2.57	V
IN UVLO Hysteresis	IN_UVLO_HYS			100		mV
IN Shutdown Current	I_{IN_SHDN}	EN = GND, $V_{IN} = 3.3V$, $T_A = 25^\circ C$		7	12	μA
IN Quiescent Current	I_{IN_Q}	$V_{EN} = V_{IN} = 3.3V$, no switching.		1.5	2.5	mA
V18 REGULATOR						
V18 Output Voltage			1.72	1.8	1.88	V
V18 Current Limit			60			mA
V18 Undervoltage Lockout		V18 rising	1.6	1.65	1.7	V
V18 Undervoltage Hysteresis				150		mV
V18OOR Diagnostic Levels			-8		+8	%
OSCILLATOR						
Operating Frequency	f_{BOOSTH}	f_{SW} bit = 0, dither disabled. Switching frequency for boost, inverter, and charge pumps.	1950	2100	2250	kHz
	f_{BOOSTL}	f_{SW} bit = 1, dither disabled. Switching frequency for boost, inverter, and charge pumps.	385	420	455	
Frequency Dither	f_{BOOSTD}			± 6		%
BOOST REGULATOR						
HVINP Output Voltage Range	V_{HVINP}		$V_{IN} + 1$		10.5	V
AVDD Output Voltage Range			4.2		10.5	V
AVDD Adjustment Step Size				0.1		V
AVDD Output Regulation	V_{AVDD}	avdd[5:0] = 0x1A, full load current and input voltage range	6.664	6.8	6.936	V
Oscillator Maximum Duty Cycle		420kHz switching frequency	87	88.5	90	%
		2.1MHz switching frequency	84	87	90	
Low-Side Switch On-Resistance	LXP_RON_LS	$I_{LXP} = 0.1A$		0.1	0.2	Ω
Synchronous Rectifier On-Resistance				0.1	0.2	Ω
Synchronous Rectifier Zero-Crossing Threshold	ZX_TH			70		mA

Electrical Characteristics (continued)(V_{IN} = 3.3V, V_{INN} = 3.3V, Limits are 100% guaranteed between T_A = -40°C and T_A = +125°C.)

PARAMETER	SYMBOL	CONDITIONS	MIN	TYP	MAX	UNITS
LXP Leakage Current	LXP_L_LEAK	V _{EN} = 0V, V _{LXP} = 10.5V			20	μA
LXP Current Limit	I _{LIMPH}	Duty cycle = 50%	1.7	2	2.3	A
Soft-Start Period	t _{BOOST_SS}	Current-limit ramp		5		ms
INVERTING REGULATOR						
Oscillator Maximum Duty Cycle		2.1MHz switching frequency	92	95		%
	INV_MAXDC	420kHz switching frequency	88	90		
V _{AVDD} + V _{NAVDD} Regulation Voltage	V _{NAVDD_AVDD_REG}	V _{INN} = 2.65V to 5.5V, V _{AVDD} = 6.8V, 1mA < I _{NAVDD} < 200mA, I _{AVDD} = same load as NAVDD	-34	0	34	mV
LXN On-Resistance	LXN RON	INN to LXN, I _{LXN} = 0.1A		0.25	0.5	Ω
LXN Leakage Current	LXN_LEAK	V _{IN} = 3.6V, V _{LXN} = V _{NAVDD} = -6.8V, T _A = +25°C			20	μA
LXN Current Limit	I _{LIMNH}	Duty cycle = 80%	1.55	1.9	2.25	A
Soft-Start Period	t _{INV_SS}	Current-limit ramp		5		ms
NAVDD Discharge Resistance				2		kΩ
POSITIVE CHARGE-PUMP REGULATOR						
V _{GON} Threshold for Charge-Pump Switching Enable				V _{HVINP-0.8}		V
FC1-, FC2- Switches Current Limit, High-side			90	120		mA
FC1-, FC2- Switches Current Limit, Low-side			72	100		mA
FC1-, FC2- to CPGND On-Resistance				4	6.5	Ω
FC1-, FC2- to HVINP On-Resistance				6	10.5	Ω
FC2+ to PGVDD, FC1+ to FC2+ and V _{GON} to FC1+ Switches On-Resistance				2.5	4.5	Ω
V _{GON} Voltage Range, I ² C Mode			7.6		20.2	V
V _{GON} Adjustment Step Size, I ² C Mode				0.2		V
V _{GON} Output Voltage	V _{VGON}	vgon[5:0] = 0x16, full load current and V _{HVINP} > 5V, charge-pump tripler	11.7	12	12.3	V
V _{GON} Discharge Resistance			2.2	3	3.8	kΩ
NEGATIVE CHARGE-PUMP REGULATOR						
DN Current Limit			75	100		mA

Electrical Characteristics (continued)(V_{IN} = 3.3V, V_{INN} = 3.3V, Limits are 100% guaranteed between T_A = -40°C and T_A = +125°C.)

PARAMETER	SYMBOL	CONDITIONS	MIN	TYP	MAX	UNITS
V _{G_{OFF}} Voltage Range, I ² C Mode			-18.2		-5.6	V
V _{G_{OFF}} Adjustment Step Size, I ² C Mode				0.2		V
V _{G_{OFF}} Output-Voltage Accuracy		vgoff[5:0] = 0x16, full load current and input voltage range, 420kHz operation.	-10.3	-10	-9.7	V
DN On-Resistance, High-Side				6	10	Ω
DN On-Resistance, Low-Side		I _{DN} = -10mA		3.5	6.5	Ω
V _{G_{OFF}} Discharge Current				1.5		mA
SEQUENCE SWITCHES						
AVDD ON Resistance	R _{ONAVDD}	Between HVINP and AVDD, I _{AVDD} = 200mA		0.5	1	Ω
AVDD Current Limit	I _{LIMPOS}		300		600	mA
AVDD Discharge Resistance				1.2		kΩ
PGVDD On resistance		(HVINP-PGVDD), I _{PGVDD} = 3mA		6	9	Ω
PGVDD Current Limit		Expires when PGVDD charging is completed	80	100		mA
FAULT PROTECTION						
Fault Timeout		tfault[1:0] = 10		60		ms
Fault Retry Time		tretry[1:0] = 10 or 11		1.9		s
FLTB Output Frequency		Stand-alone mode only	0.88	1	1.12	kHz
FLTB Output Duty Cycle, V _{G_{ON}} or V _{G_{OFF}} Fault		Stand-alone mode only		75		%
FLTB Output Duty Cycle with AVDD, NAVDD or HVINP Fault		Stand-alone mode only		50		%
FLTB Output Duty Cycle, VCOM Fault		Stand-alone mode only		25		%
AVDD Undervoltage Fault Threshold		Relative measurement between HVINP and AVDD	80	85	90	%
HVINP Overvoltage Fault Threshold		Of set value	110	115	120	%
AVDD Short-Circuit Fault Threshold		Relative measurement between HVINP and AVDD	35	40	45	%
NAVDD Undervoltage Fault Threshold		Measured with respect to AVDD	80	85	90	%
NAVDD Overvoltage Fault Threshold			110	115	120	%

Electrical Characteristics (continued)(V_{IN} = 3.3V, V_{INN} = 3.3V, Limits are 100% guaranteed between T_A = -40°C and T_A = +125°C.)

PARAMETER	SYMBOL	CONDITIONS	MIN	TYP	MAX	UNITS
NAVDD Short-Circuit Fault Threshold		Measured with respect to AVDD	35	40	45	%
V _{GON} Undervoltage Fault Threshold		Of set value	80	85	90	%
V _{GON} Overvoltage Fault Threshold		Of set value	110	115	120	%
V _{GON} Short-Circuit Fault Threshold		V _{GON} Falling		V _{HVINP} -1.1		V
V _{GOFF} Undervoltage Fault Threshold		Of set value	80	85	90	%
V _{GOFF} Overvoltage Fault Threshold		Of set value	110	115	120	%
V _{GOFF} Short-Circuit Fault Threshold			35	40	45	%
Short-Circuit and Overload Fault Delay				10		µs
Bandgap Out-Of-Range Diagnostic Threshold				±11		%
VCOM BUFFER						
VCOMN Output Voltage		I _{VCOM} = 120mA, V _{NAVDD} = -10.5V		-3.5	-3.2	V
VCB Output Current			5	12	21	mA
VCOM Output Current Limit, Sinking		Dynamic output current, t < t _{FAULT}	120	200	300	mA
VCOM Output Current Limit, Sourcing	I _{LIMCOMP}	Dynamic output current, t < t _{FAULT}	120	200	300	mA
VCOM Overcurrent Detection Threshold			60	70	85	of I _{LIMCOMP}
VCOM Offset Voltage, Complete Range		V _{VCOM} = -2.49V and V _{VCOM} = +1V, no load	-25		+25	mV
VCOM Offset Voltage, 25°C		T _A = 25°C, V _{VCOM} = -0.5V	-6		+6	mV
VCOM Offset Voltage		V _{VCOM} = -0.5V	-10		+10	mV
VCOM Output Voltage Range		Temperature compensation disabled	-2.49		1	V
VCOM DAC Step Size				6.83		mV
VCOM Buffer Slew Rate		C _{VCOM} = 10nF, V _{VCOM} from -2.49V to +1V		0.72		V/µs
VCOM Fault Threshold		Deviation from set voltage		±0.25		V
VCOM Fault Detection Filter Time		t _{fault} [1:0] = 10		60		ms
VCOM Discharge Resistance		to GND	9	14	22	kΩ

Electrical Characteristics (continued)(V_{IN} = 3.3V, V_{INN} = 3.3V, Limits are 100% guaranteed between T_A = -40°C and T_A = +125°C.)

PARAMETER	SYMBOL	CONDITIONS	MIN	TYP	MAX	UNITS
R_{REF} INPUT						
R _{REF} Input Voltage Range			0		1.25	V
R _{REF} ADC Resolution				4.88		mV
R _{REF} Conversion Rate				128		kHz
TEMP Voltage	V _{TEMP}	I _{TEMP} = 10 to 500μA		625		mV
TEMP Current Mirror Gain		I _{TEMP} = 10 to 500μA		1		μA/μA
Internal Temperature Sensor Voltage		T _A = 25°C		620		mV
R _{REF} DAC Offset				5		mV
R _{REF} DAC Full-Scale Error				5		mV
R _{REF} DAC Gain Error			-0.4		+0.4	%
R _{REF} DAC Differential Non-linearity				0.5		LSB
R _{REF} DAC Integral Non-Linearity				0.5		LSB
LOGIC INPUTS and OUTPUTS (EN, SCL, ADD, SDA)						
EN Glitch Filter	EN_BLK			10		μs
EN Minimum Low Time For Reset		C _{V18} = 1uF	1			ms
EN Input Logic-High			1.22			V
EN Input Logic-Low					0.6	V
ADD Input Logic-High			1.22			V
ADD Input Logic-Low					0.66	V
ADD Input Pulldown Current				10	12	μA
SCL, SDA Input, Logic-High			1.22			V
SCL, SDA Input, Logic-Low					0.6	V
SCL Input Leakage Current			-1		+1	μA
FLT _B , SDA Output Low Voltage	V _{OL}	Sinking 5mA			0.4	V
FLT _B , SDA Output Leakage Current	I _{LEAK}	5.5V	-1		+1	μA
PROGRAMMING VOLTAGE						
V _{PROG} Voltage			8.2	8.5	8.8	V
V _{PROG} Voltage Undervoltage Threshold		V _{PROG} rising		8	8.2	V

Electrical Characteristics (continued)(V_{IN} = 3.3V, V_{INN} = 3.3V, Limits are 100% guaranteed between T_A = -40°C and T_A = +125°C.)

PARAMETER	SYMBOL	CONDITIONS	MIN	TYP	MAX	UNITS
V _{PROG} Voltage Overvoltage Threshold		V _{PROG} falling	8.8	9		V
V _{PROG} Input Current		During NV programming, T _A = 25°C		9	25	mA
NV Programming Time				16	20	ms
THERMAL SHUTDOWN						
Thermal Warning Threshold				125		°C
Thermal-Shutdown Threshold	T _{SHDN}			160		°C
Thermal-Shutdown Hysteresis	T _{SHDN_HYS}			15		°C
I²C INTERFACE						
Clock Frequency	f _{SCL}				0.4	MHz
Hold Time (Repeated) START	t _{HD:STA}		600			ns
SCL Low Time	t _{LOW}		1300			ns
SCL High Time	t _{HIGH}		600			ns
Setup Time (Repeated) START	t _{SU:STA}		600			ns
Data Hold Time	t _{HD:DAT}		0			ns
Data Setup Time	t _{SU:DAT}		100			ns
Setup Time for STOP Condition	t _{SU:STO}		600			ns
Spike Suppression				50		ns

Note 1: Note 1: Limits are 100% tested at T_A = +25°C. Limits over the operating temperature range and relevant supply voltage range are guaranteed by design and characterization.

Typical Operating Characteristics

($V_{IN} = +3.3V$, $F_{SW} = 2.1MHz$, $T_A = +25\text{ C}$ unless otherwise noted.)

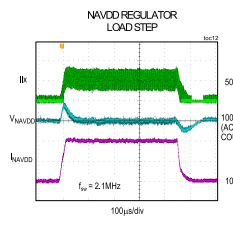
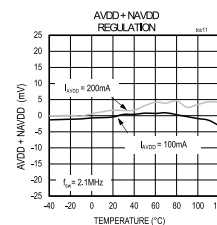
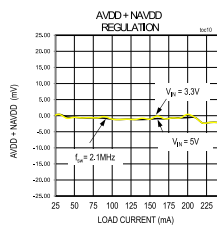
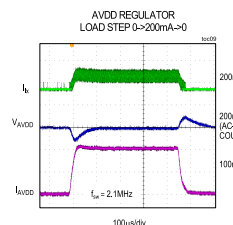
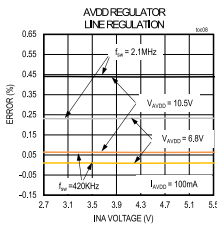
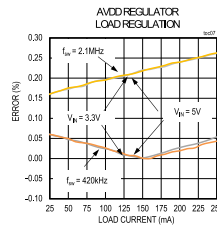
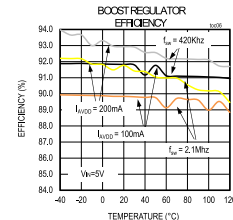
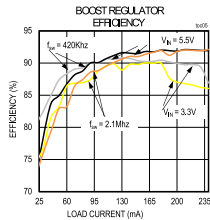
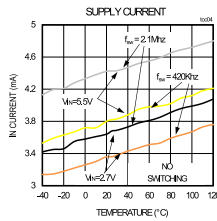
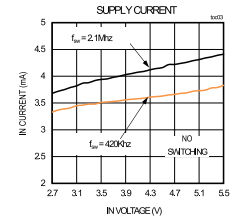
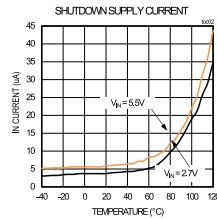
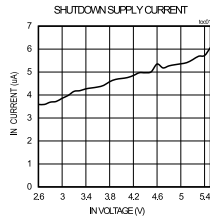

Typical Operating Characteristics (continued)

($V_{IN} = +3.3V$, $F_{SW} = 2.1MHz$, $T_A = +25\text{ C}$ unless otherwise noted.)

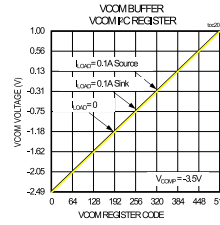
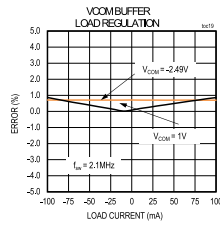
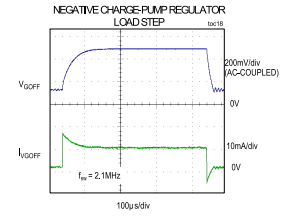
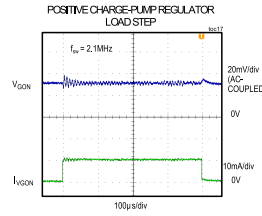
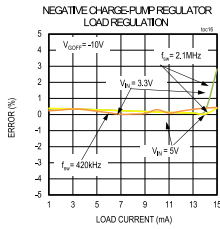
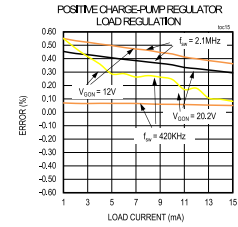
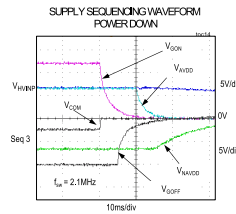
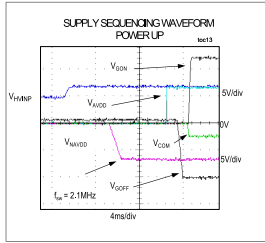

Pin Configuration

MAX25222

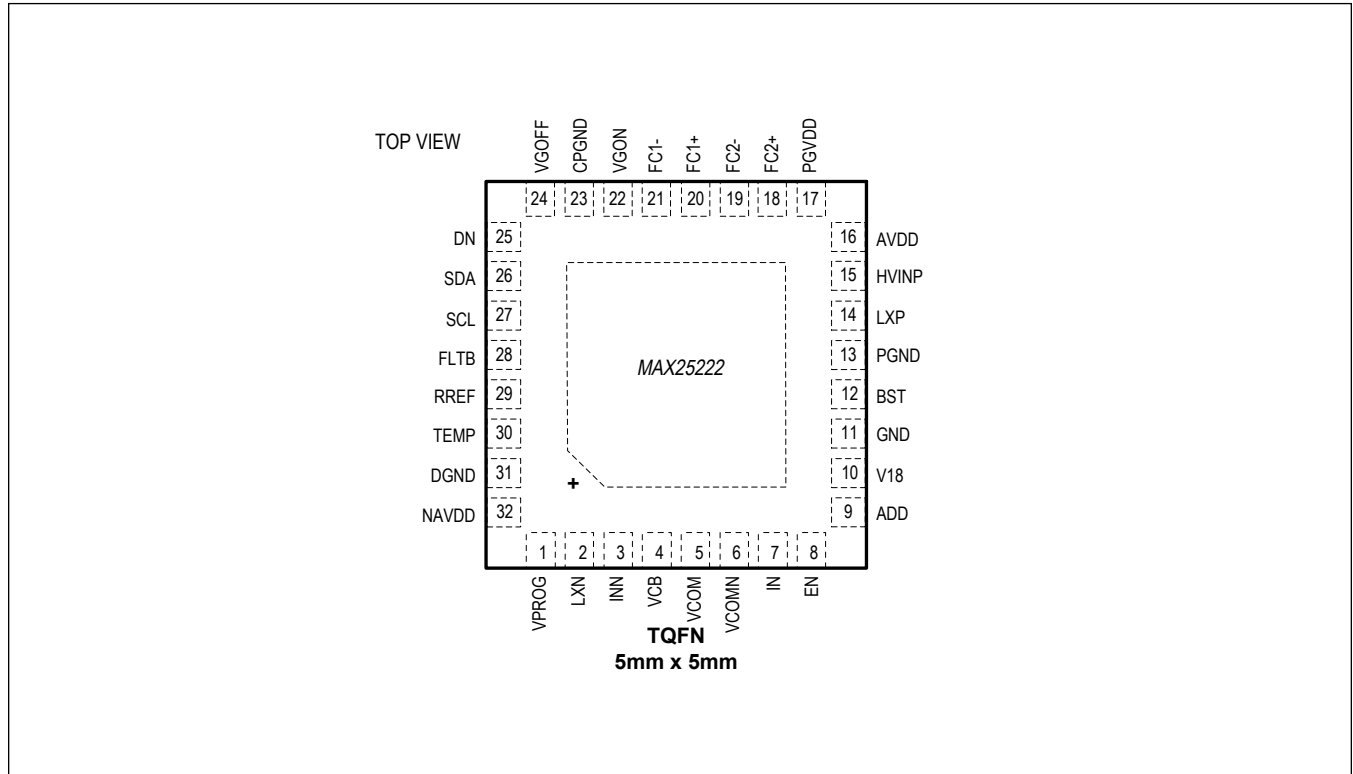

Pin Description

PIN	NAME	FUNCTION
1	VPROG	Programming Voltage. Apply a voltage of 8.5V to this pin during the programming of non-volatile registers. Connect to GND through a resistor during normal operation.
2	LXN	DC-DC Inverting Converter Inductor/Diode Connection.
3	INN	Inverting Converter Input. Connect 10µF + 0.1µF ceramic capacitors from this pin to ground for proper operation.
4	VCB	Drive Output for External npn Pass Transistor for VCOMN regulator. Connect to the base of the external npn transistor.
5	VCOM	Output of VCOM amplifier.
6	VCOMN	Negative Supply for VCOM Buffer. Connect a ceramic capacitor of at least 1µF from VCOMN to GND.
7	IN	Supply Connection for Display Bias Circuitry. Bypass IN with local 10µF and 0.1µF capacitors.
8	EN	Enable Input Pin. When EN is low, the device is in shutdown. When EN is taken high, the device is active. In stand-alone mode, the outputs are turned on in the stored sequence when EN goes high.
9	ADD	Device Address Select pin. Connect to GND or V18 to Select the Device I ² C address table. To use stand-alone mode (without I ² C) leave the ADD pin open. In this mode, the device turns on all outputs in the programmed sequence when EN is taken high.
10	V18	Output of Internal 1.8V Regulator. Connect a 1µF capacitor from V18 to GND.

Pin Description (continued)

PIN	NAME	FUNCTION
11	GND	Ground Connection
12	BST	Bootstrap Capacitor Connection for Synchronous Rectifier Driver. Connect a 0.1µF ceramic capacitor between BST and LXP.
13	PGND	Ground Connection for Boost Switching Device and VCOM Buffer. Connect to GND using a low-impedance trace.
14	LXP	Switching Node of Boost Converter. Connect the boost inductor between LXP and IN.
15	HVINP	Boost Output and Input to Positive and Negative Charge-Pump Drivers. Bypass HVINP with a 10µF output capacitor placed close to the pin.
16	AVDD	Switched Output of Boost Converter. Connect a bypass capacitor of value 2.2µF from AVDD to PGND.
17	PGVDD	Supply Voltage for Positive Charge Pump. PGVDD is connected to HVINP by means of an internal switch when the positive charge pump is enabled. Bypass PGVDD with a ceramic capacitor of 1µF to GND.
18	FC2+	Positive Connection for Second Flying Capacitor. Connect a 22nF capacitor from FC2- to FC2+.
19	FC2-	Negative Connection for Second Flying Capacitor. Connect a 22nF capacitor from FC2- to FC2+.
20	FC1+	Positive Connection for First Flying Capacitor. Connect a 22nF capacitor from FC1- to FC1+.
21	FC1-	Negative Connection for First Flying Capacitor. Connect a 22nF capacitor from FC1- to FC1+.
22	VG _{ON}	Output of Positive Charge-Pump Block. Connect a 1µF capacitor from VG _{ON} to GND.
23	CPGND	Ground Connection for Charge Pumps.
24	VG _{OFF}	Output of Negative Charge-Pump Block. Connect a 1µF capacitor from this pin to GND.
25	DN	Negative Charge-Pump Push-Pull Drive Output.
26	SDA	Bidirectional I ² C Data Pin.
27	SCL	I ² C Clock Pin.
28	FLT _B	Open-Drain, Active-Low Fault Output. Connect a pullup resistor from FLT _B to a logic supply ≤5V. In stand-alone mode, the duty cycle of the FLT _B pin indicates an error condition, if present (see Table 3). When the serial interface is used, FLT _B is either a 0 (indicating data to be read from the internal registers) or a 1.
29	R _{REF}	Reference Resistor Pin. When using the temperature compensation function connect an NTC from R _{REF} to GND. If unused leave R _{REF} unconnected.
30	TEMP	Connect a Resistor from TEMP to GND when Using the Temperature Compensation Function. Otherwise leave TEMP unconnected.
31	DGND	Logic Ground.
32	NAVDD	Negative Source-Driver Output Voltage. Connect ceramic capacitors of value 0.1µF and 10µF from this pin to GND with the smallest capacitor closest to the pin.

Functional Diagrams

MAX25222

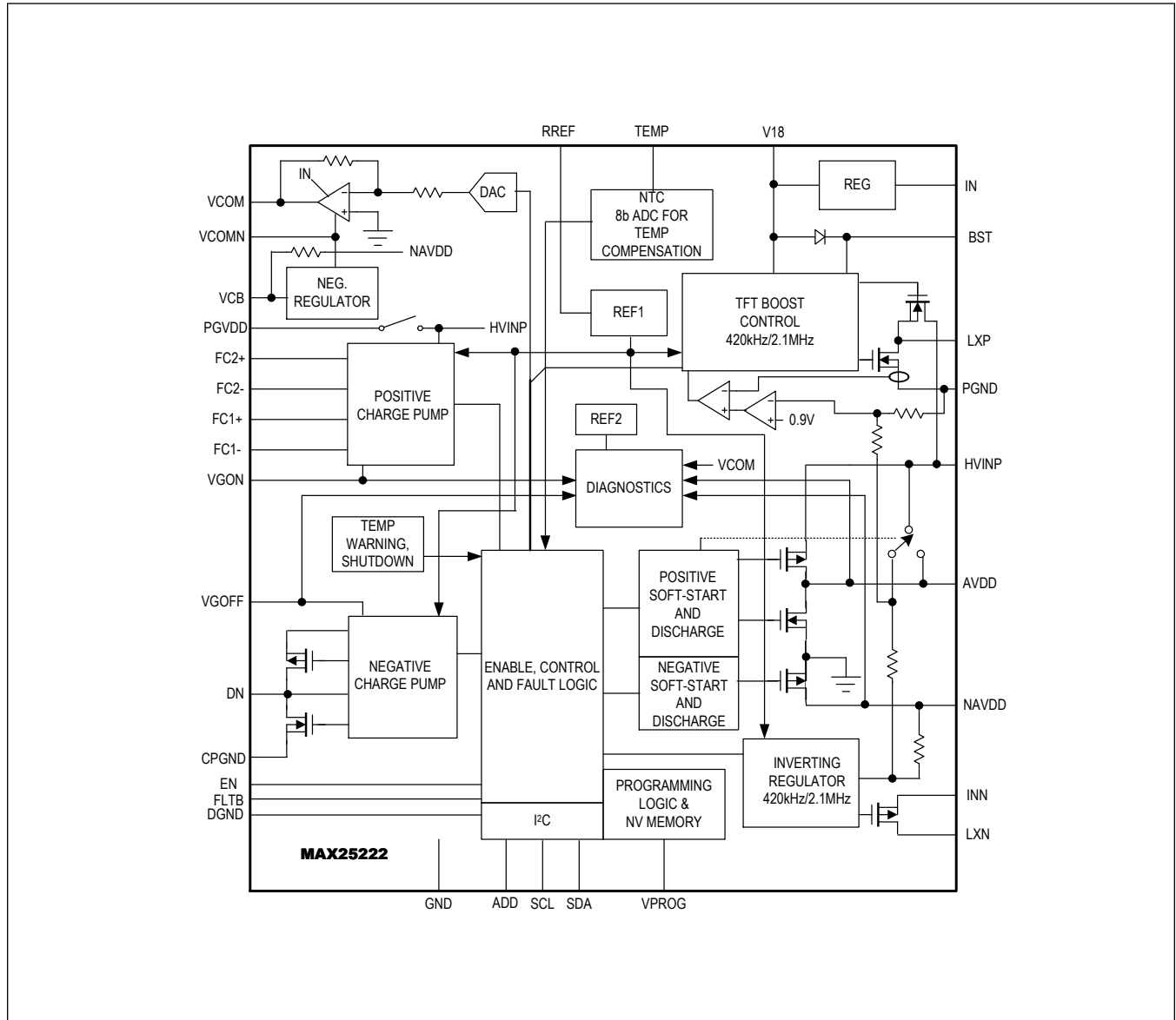

Detailed Description

The MAX25222 is a 4-channel TFT-LCD power IC that provides symmetrical positive AVDD and negative NAVDD supplies as well as V_{GON} and V_{GOFF} gate supplies. In addition, a VCOM buffer with output voltage range above and below ground and a temperature-measurement block are integrated.

The device contains non-volatile memory so that the values of all outputs can be calibrated for the lifetime of the device. Programming is carried out using the built-in I²C interface, which can also be used to read back diagnostic information. Operation in stand-alone mode is also possible.

The temperature-sensor interface block determines the temperature by measuring the voltage on the R_{REF} pin when a temperature-sensitive component, such as an NTC, is connected to TEMP. The VCOM output voltage can be adjusted as a function of the measured temperature.

Power-Up state

After the device supply voltage on IN exceeds the undervoltage lockout voltage of 2.5V and the 1.8V regulator is in regulation, the device is functional after a delay of 1ms. If the non-volatile memory has been written to previously and the ADDR pin is open (stand-alone mode) the stored values are read and the outputs are turned on in the programmed sequence when the EN pin is taken high. Otherwise, the device powers up with the default voltages of 6.8V (AVDD), 12V (V_{GON}) and -10V (V_{GOFF}).

Alternatively, when I²C is used, all values can be programmed and the outputs turned on using the START bit in the REG_CTRL register. The values can subsequently be stored in non-volatile memory using the burn_otp command, if required.

If at any time the internal 1.8V regulator is out of range, the v18oor bit is set in register FAULT2 and the FLTB pin is asserted low, assuming the device is being used in I²C mode. No other action is taken unless the V18 voltage is below its undervoltage lockout level.

Switching Frequency

The switching frequency of the boost and inverting converters and the charge pumps is set using the f_{SW} bit in register CONFIG. When f_{SW} is 0, the switching frequency is 2.1MHz. When f_{SW} is set to 1, the switching frequency is 420kHz. The switching frequency can have spread-spectrum applied to improve EMI performance using the en_ss bit in register CONFIG.

Stand-Alone Operation

Stand-alone operation is used when the device has already been programmed and should start up with the pre-programmed values when power is applied and the EN pin taken high. In stand-alone mode, leave the ADD pin unconnected.

Source Driver Power Supplies

The source-driver power supplies consist of a boost converter with output switch and an inverting buck-boost converter that generate up to +10.5V maximum and down to -10.5V minimum, respectively, and can deliver up to 200mA on the positive regulator and -200 mA on the negative regulator. The positive source-driver power supply's regulation voltage (AVDD) is set by writing the avdd[5:0] value in the AVDD_SET register using the I²C interface, and can be programmed into non-volatile memory. The default AVDD output voltage is 6.8V.

The negative source-driver supply voltage (NAVDD) is automatically tightly regulated to -AVDD within ±34mV. NAVDD cannot be adjusted independently of AVDD.

The AVDD boost converter is a current-mode converter with two internal switches and internal compensation. The direct output of the converter is HVINP while AVDD is a switched-output version. The NAVDD converter is a current-mode converter with one internal switch, an external diode and internal compensation.

Gate-Driver Power Supplies

The positive gate-driver power supply (V_{GON}) is a regulated charge-pump tripler and generates up to +20.2V. Note also that the maximum output voltage is $3 \times AVDD - R_{ONTOTAL} \times I_{VGON} \times K$, where $R_{ONTOTAL}$ is typically 30Ω and K is a factor 0.75. In cases where a doubler charge pump is sufficient, set the `cp_2stage` bit and leave pins FC1- and FC1+ unconnected in order to increase efficiency.

The negative gate-driver power supply ($V_{G_{OFF}}$) generates a maximum negative voltage of -18.2V and requires external diodes and capacitors. The V_{GON} and $V_{G_{OFF}}$ blocks switch at the same frequency as the AVDD and NAVDD converters.

Both supplies are capable of output currents up to 15mA, assuming sufficient headroom. The V_{GON} and $V_{G_{OFF}}$ regulation voltages are set by writing the `vgon[5:0]` and `vgoff[5:0]` values in the register map using the I²C interface, and can be stored in the non-volatile section of the register map.

Sequencing

The power-on and power-off sequences are controlled by the `seq_set[2:0]` bits in the `VCOM_L` register. The setting should be written before the sequence is to be executed and should not be changed during the turn-on or turn-off sequences. The sequence options are as follows:

Table 1. Available Sequences

Sequence No.	SEQUENCE SET BITS			POWER-ON				POWER-OFF (REVERSE-ORDER OF POWER-ON)				NOTES
	<code>seq_set2</code>	<code>seq_set1</code>	<code>seq_set0</code>	1st	2nd after t1 ms	3rd after t2 ms	4th after t3 ms	1st	2nd after t3 ms	3rd after t2 ms	4th after t1 ms	
1	0	0	0	AVDD	NAVDD	$V_{G_{OFF}}$	V_{GON}/V_{COM}	V_{GON}/V_{COM}	$V_{G_{OFF}}$	NAVDD	AVDD	
2	0	0	1	AVDD	NAVDD	V_{GON}	$V_{G_{OFF}}/V_{COM}$	$V_{G_{OFF}}/V_{COM}$	V_{GON}	NAVDD	AVDD	
3	0	1	0	NAVDD	AVDD	$V_{G_{OFF}}$	V_{GON}/V_{COM}	V_{GON}/V_{COM}	$V_{G_{OFF}}$	AVDD	NAVDD	Default setting
4	0	1	1	NAVDD	AVDD	V_{GON}	$V_{G_{OFF}}/V_{COM}$	$V_{G_{OFF}}/V_{COM}$	V_{GON}	AVDD	NAVDD	
5	1	0	0	NAVDD	$V_{G_{OFF}}$	AVDD	V_{GON}/V_{COM}	V_{GON}/V_{COM}	AVDD	$V_{G_{OFF}}$	NAVDD	
6	1	0	1	$V_{G_{OFF}}$	V_{GON}	NAVDD	AVDD/ V_{COM}	AVDD/ V_{COM}	NAVDD	V_{GON}	$V_{G_{OFF}}$	
7	1	1	0	AVDD/ NAVDD	$V_{G_{OFF}}$	V_{GON}/V_{COM}	-	V_{GON}/V_{COM}	$V_{G_{OFF}}$	AVDD/ NAVDD	-	
8	1	1	1	AVDD/ NAVDD	V_{GON}	$V_{G_{OFF}}/V_{COM}$	-	$V_{G_{OFF}}/V_{COM}$	V_{GON}	AVDD/ NAVDD	-	

The times in the above table are determined by the `delayt1`, `delayt2` and `delayt3` settings in the `DELAY-VCOM_LSB` register. The fastest power-up is obtained by setting the delays to 0.

The output voltages are not monitored during off sequencing; each output is turned off in turn using the programmed delays. When the delays are set to zero, outputs are turned off in sequence with 1ms delays. A sequence can be stored in non-volatile memory by writing to the `burn_otp_reg` register.

The V18 linear regulator is powered down 200ms after the power-down sequence is complete. After this time, the device is in shut-down mode and can be restarted by setting the EN input high.

Sequencing Diagram

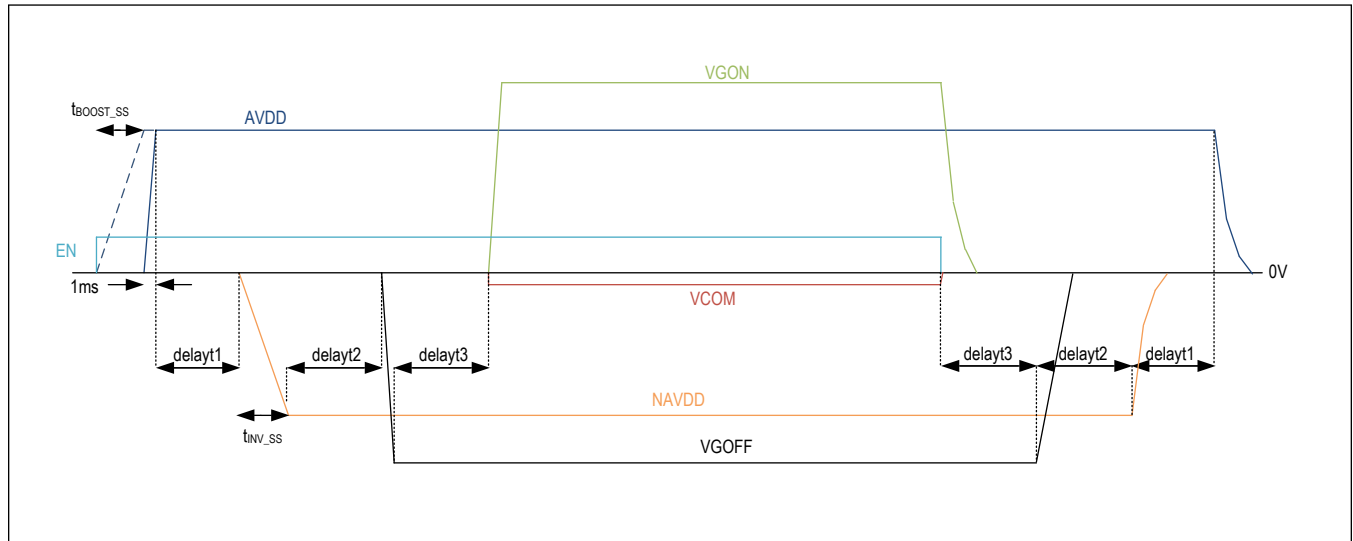

Figure 1. Sequencing Example (Sequence 1, Not to Scale)

VCOM Buffer

The VCOM output voltage is programmed using I²C to a value between -2.49V and +1V. The 9-bit value can also be stored in non-volatile memory. The most-significant bits of the VCOM voltage setting are in the VCOM25 register while the least-significant bit is the vcom25_0 bit in the DELAY-DELAYVCOM_LSB register.

The VCOM buffer can output peak currents up to ±120mA. If the VCOM output voltage deviates from the set value by more than 0.25V, a VCOM fault is detected and flagged with the vcom_flt bit in the FAULT2 register. When this fault is detected, the VCOM buffer continues to function—it is not automatically disabled. Note that a fault condition can lead to high power dissipation in the VCOM buffer and could lead to thermal shutdown of the entire device. If the VCOM buffer is continuously in current limit for more than the time set by tfault[1:0], it is disabled together with the AVDD, NAVDD, VG_H and VG_L outputs to avoid damage to the IC. Also in this case the vcom_flt bit is set.

The maximum capacitive load on the VCOM output is 10nF. If higher capacitance loads are used, a series resistor should be employed to maintain stability.

To calculate the value to write to the VCOM25 register use the following equation:

$$VCOM25 = \frac{V_{COM} + 2.49}{0.00683}$$

The correspondence between the VCOM set value and the VCOM voltage is shown in table 2.

Table 2. VCOM Settings

VCOM25 REGISTER VALUE	VCOM VOLTAGE (V)
0x1FF	1
0x1FE	0.9932
...	...
0x16E	+0.0098
0x16D	+0.003
0x16C	-0.0039
...	...

Table 2. VCOM Settings (continued)

0x002	-2.4763
0x001	-2.4832
0x000	-2.49

VCOMN Negative Power Supply

A linear regulator is implemented to derive a regulated -3.5V for the VCOM buffer from the NAVDD supply. The npn transistor connected to the VCB pin acts as the pass transistor of the regulator. The peak output current of the regulator is the same as the peak negative drive current from the VCOM output, or at least 120mA. The device senses the voltage at VCOMN and regulates it to -3.5V by driving VCB. The peak drive current for the base of the external npn is at least 5mA.

Limiting the Range of VCOM Voltage

When temperature compensation is not enabled, it is possible to limit the excursion of VCOM to a range between the values set in the VCOM_MIN and VCOM_MAX registers. If an attempt is made to write a value outside the set range to VCOM25, the VCOM output voltage is not updated and the I²C interface issues a NACK.

VCOM Temperature Compensation

The VCOM output voltage can be compensated for temperature changes using a temperature-sensitive component (e.g. an NTC thermistor) connected to the TEMP input or an internal temperature sensor. Select the sensor to be used with the int_sensor bit in the CONFIG register (the default configuration is to use the external sensor). The TEMP pin is forced to 625mV and the current drawn from it is mirrored on the R_{REF} pin. The voltage generated due to the resistor on R_{REF} is fed to the internal 8-bit ADC, which has a reference voltage of 1.25V. The input to the ADC is therefore as follows:

$$V_{ADC} = \frac{0.625 \times R_{RREF}}{R_{TEMP}}$$

With reference to [Figure 2](#): $R_{TEMP} = (R_{NTC} \parallel R1) + R2$

The highly non-linear NTC characteristic can be modified depending on which temperature (cold, room, or hot) necessitates the highest resolution. As an example in [Figure 2](#), a reference resistor is connected to R_{REF} while a combination of the NTC and two low-TC resistors R1 and R2 are connected to TEMP. In this way, an ADC reading that is steeper at higher temperatures is obtained, enhancing the resolution of the ADC there. When temperature compensation is enabled, the value of the voltage on the R_{REF} pin is available in the TEMP (0x01) register.

Temperature compensation is enabled by setting the T_comp_en bit in the DELAY-VCOM_LSB register. When T_comp_en is high, the voltage on the R_{REF} pin is measured and the VCOM output voltage is updated at a rate of 1Hz. At start-up, even with temperature compensation enabled, there is a delay before compensation becomes active due to the time needed to sample the temperature. For this reason, the device always starts up with the VCOM25 voltage value on VCOM.

The VCOM value at 25°C is the value written in the VCOM25 register together with the LSB from DELAY-VCOM_LSB register. This value serves as the reference for all other VCOM values. The 5-bit values in the VCOM_L, and VCOM_H1 registers represent the change in VCOM from the VCOM25 value at the temperature represented by an ADC reading of VTEMP_L and VTEMP_H1. The value in the VCOM_H2 register represents the positive shift in VCOM from VCOM_H1. The VCOM_L value represents a negative shift in VCOM while VCOM_H1 and VCOM_H2 represent positive shifts.

NTC Connection Diagram

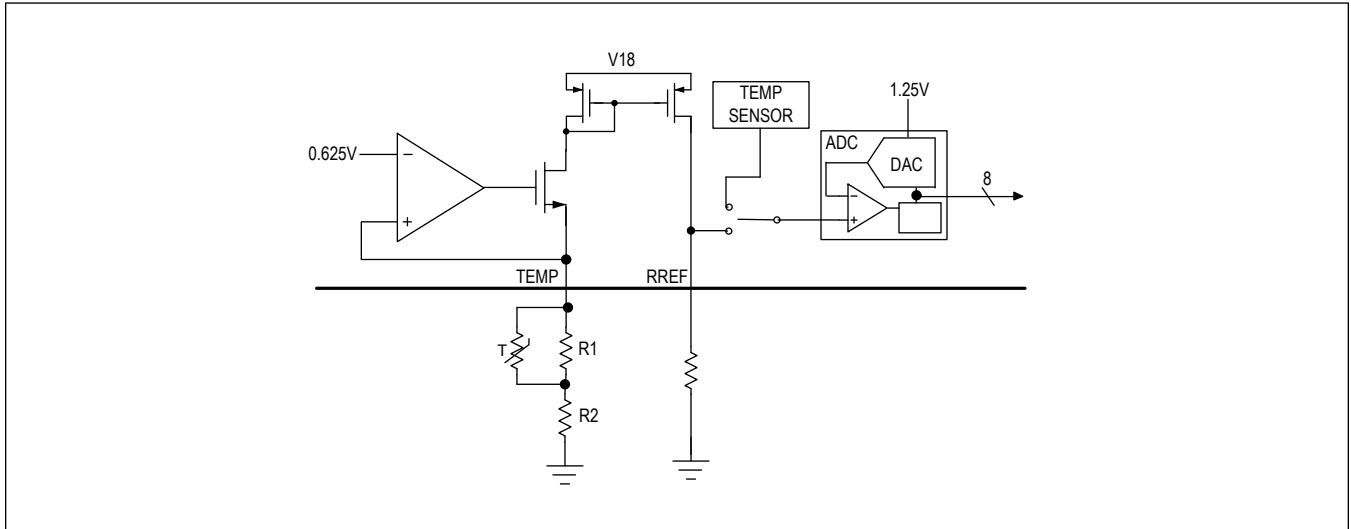

Figure 2. Possible NTC Connection

Internal Temperature Sensor

The internal temperature sensor senses the junction temperature of the IC which may be significantly different from the ambient temperature. To use the internal sensor, set the int_sensor bit in the CONFIG register to 1. The internal temperature sensor has a temperature coefficient of 2mV/°C and a nominal output voltage of 620mV at 25°C.

When the internal temperature sensor is selected, it is connected directly to the ADC input at RREF.

Temperature Compensation Curve

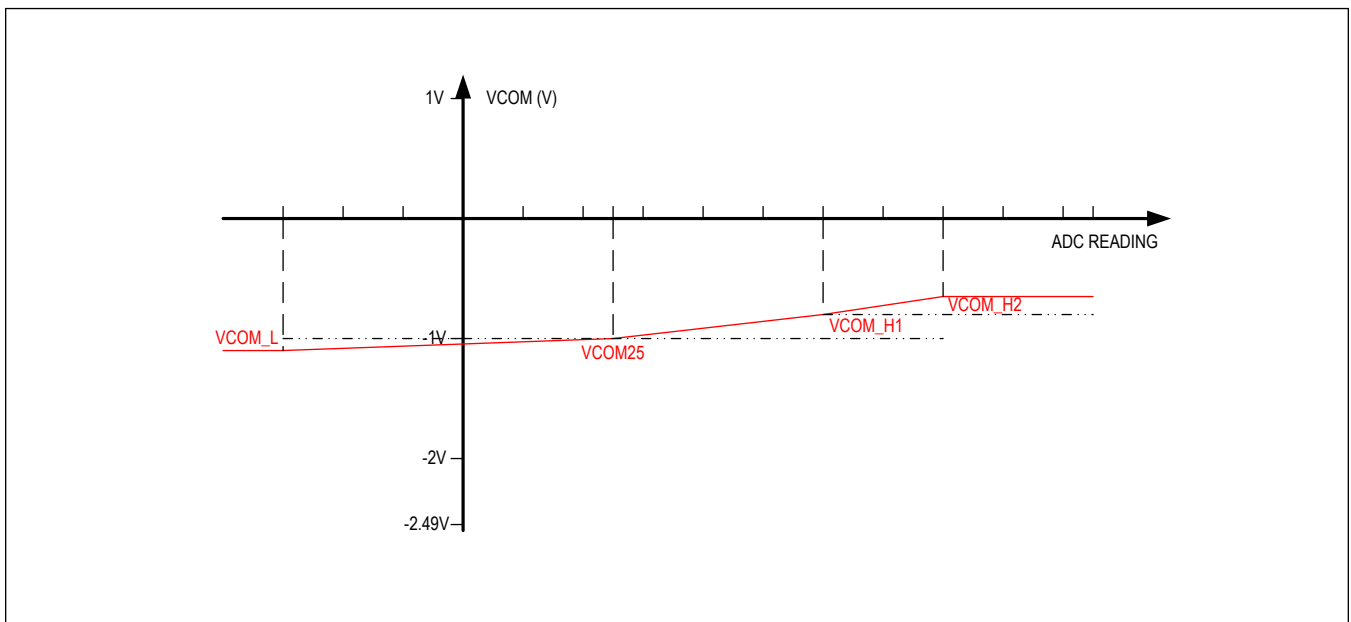

Figure 3. Temperature Compensation Curve

Fault Handling

The reaction to faults is dependent on whether the device is in I²C or stand-alone mode.

In I²C mode, the following faults, if not masked, cause the FLTB pin to assert low: avdd_uv, navdd_uv, vgon_uv, vgoff_uv, vcom_fit, nv_fit, th_shdn, vin_uvlo, and par_err. The th_warn fault is masked by default and must be explicitly enabled using the th_warn_mask bit.

In stand-alone mode the FLTB pin outputs a pulse train of varying duty cycle depending on the detected fault as shown in [Table 3](#).

Table 3. FLTB Duty Cycle in Stand-Alone Mode

DUTY-CYCLE	FAULT
75%	VG _{ON} or VG _{OFF} fault
50%	AVDD, NAVDD or HVINP fault
25%	VCOM fault
0% (continuously low)	NV fault or thermal shutdown

The frequency at the FLTB pin is 1kHz when indicating a fault. If multiple faults are present, the highest-priority fault is indicated. The list above is in order of priority with the highest priority listed last.

Undervoltage Faults on the Source, Gate and VCOM Outputs

When an undervoltage is detected on any of the AVDD, NAVDD, VG_{ON}, or VG_{OFF} outputs, all of the outputs are turned off and the appropriate fault bit is set in the FAULT1 register. At the same time, the FLTB pin asserts low. Depending on the setting of the retry[1:0] bits, the subsequent behavior of the device is as follows:

- retry = 01, 10 or 11: After 0.95s or 1.9s a retry is performed where all outputs are turned on in the appropriate sequence. If the fault is still present, the output will be disabled again after tfault[1:0]. A total of three retries are performed, after which no further retry attempts are performed (the device can be restarted by toggling power or the EN pin or by using the RESTART command). If retry = 11 retries continue until the fault is removed and normal function can resume.
- retry = 00: No retry is attempted (the device can be restarted by toggling power or the EN pin or by using the RESTART command).

If a short-circuit is encountered during start-up, device operation is halted, all outputs are disabled, and the subsequent behavior depends on the setting of retry[1:0] as described above. The short-circuit checks on VG_{ON} and VG_{OFF} are enabled 1ms after the pins are enabled.

During retry, faults are no longer monitored and the fault or faults which caused retry are indicated using the corresponding fault bits. During retry, the FLTB pin asserts low unless the fault which caused the retry is masked.

Overvoltage Faults on the Source and Gate Outputs

When an overvoltage fault occurs on any of the outputs, the fault is indicated on the FLTB pin and the specific fault can be determined by reading the appropriate register. Overvoltage faults are cleared after a register is read if the fault is no longer present. All outputs continue to be active during any overvoltage.

Further Faults

The other faults detected by the MAX25222 are as follows:

- FLTB pin stuck low or high. This is detected when the voltage on FLTB does not agree with the expected value. It is indicated by the flt_fit bit in the FLTMASK2 register.
- Bandgap reference out of range. The two internal references are constantly compared; if they differ by more than ±11%, both the hvinp_uv (FAULT2 register) and hvinp_ov (FAULT1 register) bits are asserted simultaneously.
- Communication parity error (when enabled by setting the par_en bit in the REG_CTRL register). This error causes the par_err bit in register FAULT2 to be asserted.
- VCOM DAC fault. This bit in the FLTMASK2 register is the direct output of the VCOM DAC midway comparator used to

detect a stuck DAC output. This bit does not cause FLTB to assert low and thus must be polled by the user. It is not latched, but instead reflects the output of the comparator directly.

Thermal Warning and Shutdown

When the junction temperature reaches 125°C, the thermal warning bit is set. The device takes no further action.

If the device junction temperature reaches 160°C, all outputs are turned off immediately. When the junction temperature drops by 15°C, the outputs are re-enabled using the stored sequence.

NV Memory

The MAX25222 includes five blocks of one-time-programmable memory. The user can store the block of volatile registers from 0x07 to 0x15 in non-volatile memory which is in turn mapped to register locations 0x17 to 0x25. Note that before the non-volatile memory has been programmed, a read from the locations 0x17 to 0x25 yields the result 0xFF.

The contents of the non-volatile memory are protected by a single-error correction/double-error detection (SEDED) redundant code while data transfer from non-volatile memory to registers 0x07 to 0x15 is protected by a parity check. If the parity check fails, a retry is performed two times. If all three attempts are unsuccessful, the device does not start up, the `nv_flg` bit is set, and the FLTB pin is asserted low. If the SEDED check fails, the device does not start up, the `nv_flg` bit is set, and the FLTB pin is asserted low.

If there are no errors, the outputs are turned on with the stored values and in the stored sequence.

To store the contents of registers 0x07 to 0x15 to non-volatile memory a voltage source of 8.5V \pm 2% capable of supplying more than 25mA should be connected to the `VPROG` pin. When the `VPROG` voltage is stable an I²C NV write command can be performed by writing to the `burn_otp_reg` register. If the NV write is unsuccessful (because the `VPROG` voltage was out of range or because of a general memory error) the `nv_flg` bit is set, FLTB pin goes low. After an NV write command is executed, the `nv_flg` bit should be checked. If `nv_flg` is high another NV write can be attempted.

Connect `VPROG` to GND if non-volatile memory is not used.

Ensure that temperature compensation is disabled when programming VCOM.

Auto-Refresh Function

When the refresh bit in register CONFIG is set, the device reads from the non-volatile registers at intervals of 1s and writes the data into the corresponding volatile registers. This avoids the effect of possible corruption of the volatile registers. Auto-refresh reads are subject to error correction in the same way as the initial read after device power-up.

When programming the non-volatile memory, the auto-refresh function should be enabled immediately before performing the `burn_otp_reg` write. See the section *Using the NV Memory* in [Applications Information](#).

BURN, REBOOT and RESTART Commands

The BURN and REBOOT commands are used to store the contents of registers 0x07 to 0x15 in non-volatile memory or to fetch the contents of non-volatile memory and load them into registers 0x07 to 0x15, respectively. The RESTART command is used to restart the device from a latched-fault mode. When a RESTART command is performed, all fault bits are cleared.

A BURN command is performed by writing to register address 0x78 (`burn_otp_reg`).

A REBOOT command is performed by writing to register address 0x79 (`reboot_otp_reg`).

A RESTART command is performed by writing to register address 0x7A (`soft_restart`).

When parity checking is enabled and one of these user commands is sent to the device, the third byte should be such as to have even parity over the 3 bytes sent.

I²C Interface

The MAX25222 features an I²C, 2-wire serial interface consisting of a serial-data line (SDA) and a serial-clock line (SCL). SDA and SCL facilitate communication between the IC and the master at clock rates up to 400kHz. The master, typically a microcontroller, generates SCL and initiates data transfer on the bus.

The Slave ID of the MAX25222 depends on the connection of the ADD pin according to Table 4.

A master device communicates with the MAX25222 by transmitting the correct Slave ID with appended R/W bit, followed by the register address and data word (for a write transaction only). Each transmit sequence is framed by a START (S) or Repeated START (Sr) condition, and a STOP (P) condition. Each word transmitted over the bus is 8 bits long and is always followed by an acknowledge clock pulse.

The IC's SDA line operates as both an input and an open-drain output. A pullup resistor greater than 1k Ω is required on the SDA bus. In general, the resistor should be selected as a function of bus capacitance such that the rise time on the bus is not greater than 120ns. The IC's SCL line operates as an input only. A pullup resistor greater than 1k Ω is required on SCL if there are multiple masters on the bus, or if the master in a single-master system has an open-drain SCL output. In general, for the SCL-line resistor selection, the same recommendations as for SDA apply. Series resistors in line with SDA and SCL are optional. The SCL and SDA inputs suppress noise spikes to assure proper device operation even on a noisy bus.

I²C Slave Addresses

Table 4. I²C Slave Addresses

ADD PIN CONNECTION	DEVICE ADDRESS							WRITE ADDRESS	READ ADDRESS
	A6	A5	A4	A3	A2	A1	A0		
GND	0	1	0	0	0	0	1	0x42	0x43
V18	0	1	0	1	0	0	1	0x52	0x53

Parity Checking

Even parity checking for write transactions can be enabled by setting the `par_en` bit in `REG_CTRL` to 1. The parity bit is the most-significant bit of the register address byte and should be set to attain even parity. The parity check is performed over all 3 bytes received by the device: the slave address, the register address, and the data payload. Burst-mode write is not supported when parity checking is enabled; a complete I²C transaction is needed to write to each single register. When a parity bit error is detected the `par_err` bit is set, the I²C interface issues a NACK and no write is performed.

When writing any of the BURN, REBOOT, and RESTART commands, parity must be adjusted by changing the third or payload byte; the command byte must not be changed.

Register Map

MAX25222

ADDRESS	NAME	MSB							LSB
USER REGISTERS									
0x00	DEVICE[7:0]	–	–	dev_id[5:0]					
0x01	TEMP[7:0]	temp[7:0]							
0x02	REG_CTRL[7:0]	par_en	start	–	–	–	rev_id[2:0]		
0x03	FLTMASK1[7:0]	hvinp_ov_mask	avdd_uv_mask	navdd_ov_mask	navdd_uv_mask	vgon_ov_mask	vgon_uv_mask	vgoff_ov_mask	vgoff_uv_mask
0x04	FLTMASK2[7:0]	flt_flt	par_err_mask	vin_uvlo_mask	hvinp_uv_mask	dac_flt	–	vcom_flt_mask	th_warn_mask
0x05	FAULT1[7:0]	hvinp_ov	avdd_uv	navdd_ov	navdd_uv	vgon_ov	vgon_uv	vgoff_ov	vgoff_uv
0x06	FAULT2[7:0]	v18oor	par_err	vin_uvlo	hvinp_uv	th_shdn	nv_flt	vcom_flt	th_warn
0x07	CONFIG[7:0]	int_sensor	refresh	en_ss	fSW	tretry[1:0]		tfault[1:0]	
0x08	DELAY-VCOM_LSB[7:0]	delayt1[1:0]		delayt2[1:0]		delayt3[1:0]		T_comp_en	vcom25_0
0x09	VCOM25[7:0]	vcom25[7:0]							
0x0A	VCOM_L[7:0]	seq_set[2:0]			vcom_l[4:0]				
0x0B	VCOM_H1[7:0]	–	–	–	vcom_h1[4:0]				
0x0C	VCOM_H2[7:0]	–	–	–	vcom_h2[4:0]				
0x0D	VTEMP25[7:0]	vtemp25[7:0]							
0x0E	VTEMP_L[7:0]	vtemp_l[7:0]							
0x0F	VTEMP_H1[7:0]	vtemp_h1[7:0]							
0x10	VTEMP_H2[7:0]	vtemp_h2[7:0]							
0x11	VCOM_MIN[7:0]	vcom_min[7:0]							
0x12	VCOM_MAX[7:0]	vcom_max[7:0]							
0x13	AVDD_SET[7:0]	–	–	avdd[5:0]					
0x14	VGON[7:0]	–	cp_2stage	vgon[5:0]					
0x15	VGOFF[7:0]	–	–	vgoff[5:0]					
0x17	NV_CONFIG[7:0]	nv_int_sensor	nv_refresh	nv_en_ss	nv_fSW	nv_retry[1:0]		nv_tfault[1:0]	
0x18	NV_DELAY-VCOM_LSB[7:0]	nv_delayt1[1:0]		nv_delayt2[1:0]		nv_delayt3[1:0]		nv_T_comp_en	nv_vcom25_0
0x19	NV_VCOM25[7:0]	nv_vcom25[7:0]							
0x1A	NV_VCOM_L[7:0]	nv_seq_set[2:0]			nv_vcom_l[4:0]				
0x1B	NV_VCOM_H1[7:0]	–	–	–	nv_vcom_h1[4:0]				
0x1C	NV_VCOM_H2[7:0]	–	–	–	nv_vcom_h2[4:0]				
0x1D	NV_VTEMP25[7:0]	nv_vtemp25[7:0]							
0x1E	NV_VTEMP_L[7:0]	nv_vtemp_l[7:0]							
0x1F	NV_TEMP_H1[7:0]	nv_vtemp_h1[7:0]							

ADDRESS	NAME	MSB					LSB
0x20	NV_TEMP_H2[7:0]						nv_vtemp_h2[7:0]
0x21	NV_VCOM_MIN[7:0]						nv_vcom_min[7:0]
0x22	NV_VCOM_MAX[7:0]						nv_vcom_max[7:0]
0x23	NV_AVDD_SET[7:0]	–	–				nv_avdd[5:0]
0x24	NV_VGON[7:0]	–	nv_cp_2 stage				nv_vgon[5:0]
0x25	NV_VGOFF[7:0]	–	–				nv_vgoff[5:0]
USER COMMANDS							
0x78	burn_otp_reg[7:0]						burn_otp[7:0]
0x79	reboot_otp_reg[7:0]						reboot_otp[7:0]
0x7A	soft_restart[7:0]						soft_restart[7:0]

Register Details

DEVICE (0x00)

BIT	7	6	5	4	3	2	1	0
Field	–	–	dev_id[5:0]					
Reset	–	–						
Access Type	–	–	Read Only					
BITFIELD	BITS		DESCRIPTION					
dev_id	5:0		Device ID. Reads 0x22					

TEMP (0x01)

BIT	7	6	5	4	3	2	1	0
Field	temp[7:0]							
Reset	0x0							
Access Type	Read Only							
BITFIELD	BITS		DESCRIPTION					
temp	7:0		Voltage reading from R _{REF} pin.					

REG_CTRL (0x02)

BIT	7	6	5	4	3	2	1	0
Field	par_en	start	–	–	–	rev_id[2:0]		
Reset	0x0	0x0	–	–	–	0x1		
Access Type	Write, Read	Write, Read	–	–	–	Read Only		
BITFIELD	BITS		DESCRIPTION					
par_en	7		Parity enable bit. When 1 this bit enables parity checking on write transactions to the device.					
start	6		Enable bit. When this bit is set to 1 the turn-on sequence set using the seq_set bits is executed.					

BITFIELD	BITS	DESCRIPTION
rev_id	2:0	Revision ID. Reads 0x1.

FLTMASK1 (0x03)

BIT	7	6	5	4	3	2	1	0
Field	hvinp_ov_mask	avdd_uv_mask	navdd_ov_mask	navdd_uv_mask	vgon_ov_mask	vgon_uv_mask	vgoff_ov_mask	vgoff_uv_mask
Reset	0x0	0x0	0x0	0x0	0x0	0x0	0x0	0x0
Access Type	Write, Read	Write, Read	Write, Read	Write, Read	Write, Read	Write, Read	Write, Read	Write, Read

BITFIELD	BITS	DESCRIPTION
hvinp_ov_mask	7	When 1 this bit prevents an overvoltage on AVDD from asserting FLTB low.
avdd_uv_mask	6	When 1 this bit prevents an undervoltage on AVDD from asserting FLTB low.
navdd_ov_mask	5	When 1 this bit prevents an overvoltage on NAVDD from asserting FLTB low.
navdd_uv_mask	4	When 1 this bit prevents an undervoltage on NAVDD from asserting FLTB low.
vgon_ov_mask	3	When 1 this bit prevents an overvoltage on VGON from asserting FLTB low.
vgon_uv_mask	2	When 1 this bit prevents an undervoltage on VGON from asserting FLTB low.
vgoff_ov_mask	1	When 1 this bit prevents an overvoltage on VGOFF from asserting FLTB low.
vgoff_uv_mask	0	When 1 this bit prevents an undervoltage on VGOFF from asserting FLTB low.

FLTMASK2 (0x04)

BIT	7	6	5	4	3	2	1	0
Field	flt_flt	par_err_mask	vin_uvlo_mask	hvinp_uv_mask	dac_flt	–	vcom_flt_mask	th_warn_mask
Reset	0x0	0x0	0x0	0x0	0x0	–	0x0	0x1
Access Type	Read Only	Write, Read	Write, Read	Write, Read	Read Only	–	Write, Read	Write, Read

BITFIELD	BITS	DESCRIPTION
flt_flt	7	When 1 this bit indicates that the FLTB pin is stuck high or low.
par_err_mask	6	When 1 prevents parity errors from asserting the FLTB pin.
vin_uvlo_mask	5	When 1 this bit prevents an undervoltage on IN from asserting the FLTB pin.
hvinp_uv_mask	4	Mask bit for hvinp_uv diagnostic. When 1 an undervoltage on HVINP does not cause FLTB to assert.
dac_flt	3	Output of VCOM DAC midway comparator used to detect a stuck DAC output. Does not cause FLTB to assert low. This bit is not latched but reflects the output of the comparator directly.
vcom_flt_mask	1	When 1 this bit prevents a fault on VCOM from asserting FLTB low.
th_warn_mask	0	When 1 this bit prevents an overtemperature warning from asserting FLTB low.

FAULT1 (0x05)

BIT	7	6	5	4	3	2	1	0
Field	hvinp_ov	avdd_uv	navdd_ov	navdd_uv	vgon_ov	vgon_uv	vgoff_ov	vgoff_uv
Reset	0x0	0x0	0x0	0x0	0x0	0x0	0x0	0x0
Access Type	Read Clears All	Read Clears All	Read Clears All	Read Clears All	Read Clears All	Read Clears All	Read Clears All	Read Clears All

BITFIELD	BITS	DESCRIPTION
hvinp_ov	7	When 1 this bit indicates an overvoltage on AVDD.
avdd_uv	6	When 1 this bit indicates an undervoltage on AVDD.
navdd_ov	5	When 1 this bit indicates an overvoltage on NAVDD.
navdd_uv	4	When 1 this bit indicates an undervoltage on NAVDD.
vgon_ov	3	When 1 this bit indicates an overvoltage on VG _{ON} .
vgon_uv	2	When 1 this bit indicates an undervoltage on VG _{ON} .
vgoff_ov	1	When 1 this bit indicates an overvoltage on VG _{OFF} .
vgoff_uv	0	When 1 this bit indicates an undervoltage on VG _{OFF} .

FAULT2 (0x06)

BIT	7	6	5	4	3	2	1	0
Field	v18oor	par_err	vin_uvlo	hvinp_uv	th_shdn	nv_ft	vcom_ft	th_warn
Reset	0x0	0x0	0x0	0x0	0x0	0x0	0x0	0x0
Access Type	Read Clears All	Read Clears All	Read Clears All	Read Clears All	Read Clears All	Read Clears All	Read Clears All	Read Clears All

BITFIELD	BITS	DESCRIPTION
v18oor	7	Indicates that the 1.8V output is out of range, either above its overvoltage level or below its undervoltage level.
par_err	6	Indicates that a parity error was detected on an I ² C transaction.
vin_uvlo	5	Indicates an undervoltage condition on the IN pin. When this happens the device turns off all outputs and waits for IN to return above the IN UVLO level, after which the outputs are re-enabled in the programmed sequence.
hvinp_uv	4	When 1 this bit indicates an undervoltage on the boost output, HVINP.
th_shdn	3	When 1 this bit indicates an overtemperature shutdown.
nv_ft	2	Non-volatile memory failure - unsuccessful transfer of the contents of NV memory to working memory or more than one error detected.
vcom_ft	1	When 1 indicates a fault on the VCOM output either due to it being 0.25V away from its set value (unfiltered) or because the VCOM buffer was in current limit for a time t_{fault} .
th_warn	0	When 1 this bit indicates a thermal warning.

CONFIG (0x07)

BIT	7	6	5	4	3	2	1	0
Field	int_sensor	refresh	en_ss	fSW	tretry[1:0]		tfault[1:0]	
Reset	0x0	0x0	0x0	0x0	0x1		0x0	
Access Type	Write, Read	Write, Read	Write, Read	Write, Read	Write, Read		Write, Read	

BITFIELD	BITS	DESCRIPTION	DECODE
int_sensor	7	Set this bit to 1 to use the internal temperature sensor.	
refresh	6	When this bit is 1 the contents of the NV registers are automatically copied to the volatile registers every second.	0x0: Refresh disabled. 0x1: Refresh enabled.
en_ss	5	Enable spread-spectrum by setting this bit to 1.	
fSW	4	Sets switching frequency.	0x0: 2.1MHz 0x1: 420kHz
tretry	3:2	Sets retry time after a fault.	0x0: Retry disabled 0x1: Retry after 0.95s, total 3 retries. 0x2: Retry after 1.9s, total 3 retries. 0x3: Retry after 1.9s
tfault	1:0	Sets fault delay time.	0x0: 15ms 0x1: 30ms 0x2: 60ms 0x3: 90ms

DELAY-VCOM_LSB (0x08)

BIT	7	6	5	4	3	2	1	0
Field	delayt1[1:0]		delayt2[1:0]		delayt3[1:0]		T_comp_en	vcom25_0
Reset	0x2		0x2		0x2		0x0	0x0
Access Type	Write, Read		Write, Read		Write, Read		Write, Read	Write, Read

BITFIELD	BITS	DESCRIPTION
delayt1	7:6	Set delay t1 in the start-up sequence. Choose between 0, 5ms, 10ms and 15ms.
delayt2	5:4	Set delay t2 in the start-up sequence. Choose between 0, 5ms, 10ms and 15ms.
delayt3	3:2	Set delay t3 in the start-up sequence. Choose between 0, 5ms, 10ms and 15ms.
T_comp_en	1	When 1 this bit enables temperature compensation of the output of the VCOM amplifier.
vcom25_0	0	LSB of VCOM setting at 25°C.

VCOM25 (0x09)

BIT	7	6	5	4	3	2	1	0
Field	vcom25[7:0]							
Reset	0x0							
Access Type	Write, Read							

BITFIELD	BITS	DESCRIPTION
vcom25	7:0	VCOM setting at 25°C.

VCOM_L (0x0A)

BIT	7	6	5	4	3	2	1	0
Field	seq_set[2:0]			vcom_l[4:0]				
Reset	0x2			0x00				
Access Type	Write, Read			Write, Read				

BITFIELD	BITS	DESCRIPTION	DECODE
seq_set	7:5	Sequence selection bits.	0x0: Sequence 1. 0x1: Sequence 2. 0x2: Sequence 3. 0x3: Sequence 4. 0x4: Sequence 5. 0x5: Sequence 6. 0x6: Sequence 7. 0x7: Sequence 8.
vcom_l	4:0	Delta VCOM at the temperature corresponding to VTEMP_L. This value sets the difference between the VCOM value at 25°C and that at VTEMP_L.	

VCOM_H1 (0x0B)

BIT	7	6	5	4	3	2	1	0
Field	–	–	–	vcom_h1[4:0]				
Reset	–	–	–	0x00				
Access Type	–	–	–	Write, Read				

BITFIELD	BITS	DESCRIPTION
vcom_h1	4:0	Delta VCOM at VTEMP_H1. This value sets the difference between the VCOM value at 25°C and that at VTEMP_H1.

VCOM_H2 (0x0C)

BIT	7	6	5	4	3	2	1	0
Field	–	–	–	vcom_h2[4:0]				
Reset	–	–	–	0x0				
Access Type	–	–	–	Write, Read				

BITFIELD	BITS	DESCRIPTION
vcom_h2	4:0	Delta VCOM at VTEMP_H2. This value sets the difference between the VCOM value at VTEMP_H1 and that at VTEMP_H2.

VTEMP25 (0x0D)

BIT	7	6	5	4	3	2	1	0
Field	vtemp25[7:0]							
Reset	0x0							
Access Type	Write, Read							

BITFIELD	BITS	DESCRIPTION
vtemp25	7:0	Voltage at TEMP pin at 25°C.

VTEMP_L (0x0E)

BIT	7	6	5	4	3	2	1	0
Field	vtemp_l[7:0]							
Reset	0x0							
Access Type	Write, Read							

BITFIELD	BITS	DESCRIPTION
vtemp_l	7:0	Voltage at TEMP pin corresponding to low-temperature breakpoint in VCOM compensation curve.

VTEMP_H1 (0x0F)

BIT	7	6	5	4	3	2	1	0
Field	vtemp_h1[7:0]							
Reset	0x0							
Access Type	Write, Read							

BITFIELD	BITS	DESCRIPTION
vtemp_h1	7:0	Voltage at TEMP pin corresponding to first high-temperature breakpoint in VCOM compensation curve.

VTEMP_H2 (0x10)

BIT	7	6	5	4	3	2	1	0
Field	vtemp_h2[7:0]							
Reset	0x0							
Access Type	Write, Read							

BITFIELD	BITS	DESCRIPTION
vtemp_h2	7:0	Voltage at TEMP pin corresponding to second high-temperature breakpoint in VCOM compensation curve.

VCOM_MIN (0x11)

BIT	7	6	5	4	3	2	1	0
Field	vcom_min[7:0]							
Reset	0x0							
Access Type	Write, Read							

BITFIELD	BITS	DESCRIPTION
vcom_min	7:0	Lower limit for VCOM setting.

VCOM_MAX (0x12)

BIT	7	6	5	4	3	2	1	0
Field	vcom_max[7:0]							
Reset	0xFF							
Access Type	Write, Read							

BITFIELD	BITS	DESCRIPTION
vcom_max	7:0	Upper limit for VCOM setting.

AVDD_SET (0x13)

BIT	7	6	5	4	3	2	1	0
Field	–	–	avdd[5:0]					
Reset	–	–	0x1A					
Access Type	–	–	Write, Read					

BITFIELD	BITS	DESCRIPTION	DECODE
avdd	5:0	Sets AVDD and NAVDD voltages.	0x0: 4.2 0x1: 4.3 0x2: 4.4 0x3: 4.5 0x4: 4.6 0x5: 4.7 0x6: 4.8 0x7: 4.9 0x8: 5 0x9: 5.1 0xA: 5.2 0xB: 5.3 0xC: 5.4 0xD: 5.5 0xE: 5.6 0xF: 5.7 0x10: 5.8 0x11: 5.9 0x12: 6 0x13: 6.1 0x14: 6.2 0x15: 6.3 0x16: 6.4 0x17: 6.5 0x18: 6.6 0x19: 6.7 0x1A: 6.8 0x1B: 6.9 0x1C: 7V 0x1D: 7.1 0x1E: 7.2 0x1F: 7.3 0x20: 7.4 0x21: 7.5 0x22: 7.6 0x23: 7.7 0x24: 7.8 0x25: 7.9 0x26: 8 0x27: 8.1 0x28: 8.2 0x29: 8.3 0x2A: 8.4 0x2B: 8.5 0x2C: 8.6 0x2D: 8.7 0x2E: 8.8 0x2F: 8.9 0x30: 9 0x31: 9.1 0x32: 9.2 0x33: 9.3 0x34: 9.4 0x35: 9.5 0x36: 9.6 0x37: 9.7 0x38: 9.8

BITFIELD	BITS	DESCRIPTION	DECODE
			0x39: 9.9 0x3A: 10 0x3B: 10.1 0x3C: 10.2 0x3D: 10.3 0x3E: 10.4 0x3F: 10.5

VGON (0x14)

BIT	7	6	5	4	3	2	1	0
Field	–	cp_2stage	vgon[5:0]					
Reset	–	0x0	0x16					
Access Type	–	Write, Read	Write, Read					

BITFIELD	BITS	DESCRIPTION	DECODE
cp_2stage	6	Set this bit to 1 when using a two-stage charge-pump.	

BITFIELD	BITS	DESCRIPTION	DECODE
vgon	5:0	Sets V _{GON} voltage.	0x0: 7.6 0x1: 7.8 0x2: 8 0x3: 8.2 0x4: 8.4 0x5: 8.6 0x6: 8.8 0x7: 9 0x8: 9.2 0x9: 9.4 0xA: 9.6 0xB: 9.8 0xC: 10 0xD: 10.2 0xE: 10.4 0xF: 10.6 0x10: 10.8 0x11: 11 0x12: 11.2 0x13: 11.4 0x14: 11.6 0x15: 11.8 0x16: 12 0x17: 12.2 0x18: 12.4 0x19: 12.6 0x1A: 12.8 0x1B: 13 0x1C: 13.2 0x1D: 13.4 0x1E: 13.6 0x1F: 13.8 0x20: 14 0x21: 14.2 0x22: 14.4 0x23: 14.6 0x24: 14.8 0x25: 15 0x26: 15.2 0x27: 15.4 0x28: 15.6 0x29: 15.8 0x2A: 16 0x2B: 16.2 0x2C: 16.4 0x2D: 16.6 0x2E: 16.8 0x2F: 17 0x30: 17.2 0x31: 17.4 0x32: 17.6 0x33: 17.8 0x34: 18 0x35: 18.2 0x36: 18.4 0x37: 18.6 0x38: 18.8

BITFIELD	BITS	DESCRIPTION	DECODE
			0x39: 19 0x3A: 19.2 0x3B: 19.4 0x3C: 19.6 0x3D: 19.8 0x3E: 20 0x3F: 20.2

VGOFF (0x15)

BIT	7	6	5	4	3	2	1	0
Field	–	–	vgoff[5:0]					
Reset	–	–	0x16					
Access Type	–	–	Write, Read					

BITFIELD	BITS	DESCRIPTION	DECODE
vgoff	5:0	Sets V _{G_{OFF}} voltage.	0x0: -5.6 0x1: -5.8 0x2: -6 0x3: -6.2 0x4: -6.4 0x5: -6.6 0x6: -6.8 0x7: -7 0x8: -7.2 0x9: -7.4 0xA: -7.6 0xB: -7.8 0xC: -8 0xD: -8.2 0xE: -8.4 0xF: -8.6 0x10: -8.8 0x11: -9 0x12: -9.2 0x13: -9.4 0x14: -9.6 0x15: -9.8 0x16: -10 0x17: -10.2 0x18: -10.4 0x19: -10.6 0x1A: -10.8 0x1B: -11 0x1C: -11.2 0x1D: -11.4 0x1E: -11.6 0x1F: -11.8 0x20: -12 0x21: -12.2 0x22: -12.4 0x23: -12.6 0x24: -12.8 0x25: -13 0x26: -13.2 0x27: -13.4 0x28: -13.6 0x29: -13.8 0x2A: -14 0x2B: -14.2 0x2C: -14.4 0x2D: -14.6 0x2E: -14.8 0x2F: -15 0x30: -15.2 0x31: -15.4 0x32: -15.6 0x33: -15.8 0x34: -16 0x35: -16.2 0x36: -16.4 0x37: -16.6 0x38: -16.8

BITFIELD	BITS	DESCRIPTION	DECODE
			0x39: -17 0x3A: -17.2 0x3B: -17.4 0x3C: -17.6 0x3D: -17.8 0x3E: -18 0x3F: -18.2

NV_CONFIG (0x17)

Non-volatile configuration register

BIT	7	6	5	4	3	2	1	0
Field	nv_int_sensor	nv_refresh	nv_en_ss	nv_fSW	nv_retry[1:0]		nv_tfault[1:0]	
Reset								
Access Type	Read Only	Read Only	Read Only	Read Only	Read Only		Read Only	

BITFIELD	BITS	DESCRIPTION	DECODE
nv_int_sensor	7	When this bit is 1 the internal temperature sensor is used.	
nv_refresh	6	When this bit is 1 the contents of the NV registers are automatically copied to the volatile registers every second.	
nv_en_ss	5	When this bit is 1 spread-spectrum is enabled.	
nv_fSW	4	Sets switching frequency.	0x0: 2.2MHz 0x1: 440kHz
nv_retry	3:2	Sets retry time after a fault.	
nv_tfault	1:0	Sets retry time after a fault.	

NV_DELAY-VCOM_LSB (0x18)

BIT	7	6	5	4	3	2	1	0
Field	nv_delayt1[1:0]		nv_delayt2[1:0]		nv_delayt3[1:0]		nv_T_comp_en	nv_vcom25_0
Reset							0x0	
Access Type	Read Only		Read Only		Read Only		Read Only	Read Only

BITFIELD	BITS	DESCRIPTION
nv_delayt1	7:6	Set delay t1 in the start-up sequence. Choose between 0, 5ms, 10ms and 15ms.
nv_delayt2	5:4	Set delay t2 in the start-up sequence. Choose between 0, 5ms, 10ms and 15ms.
nv_delayt3	3:2	Set delay t3 in the start-up sequence. Choose between 0, 5ms, 10ms and 15ms.
nv_T_comp_en	1	When 1 this bit enables temperature compensation of output of the VCOM amplifier.
nv_vcom25_0	0	When 1 this bit enables temperature compensation of output of the VCOM amplifier.

NV_VCOM25 (0x19)

BIT	7	6	5	4	3	2	1	0
Field	nv_vcom25[7:0]							
Reset								
Access Type	Read Only							

BITFIELD	BITS	DESCRIPTION
nv_vcom25	7:0	VCOM setting at 25°C.

NV_VCOM_L (0x1A)

BIT	7	6	5	4	3	2	1	0
Field	nv_seq_set[2:0]			nv_vcom_l[4:0]				
Reset								
Access Type	Read Only				Read Only			

BITFIELD	BITS	DESCRIPTION
nv_seq_set	7:5	Sequence selection bits.
nv_vcom_l	4:0	Delta VCOM at the temperature corresponding to VTEMP_L. This value sets the difference between the VCOM value at 25°C and that at VTEMP_L.

NV_VCOM_H1 (0x1B)

BIT	7	6	5	4	3	2	1	0
Field	–	–	–	nv_vcom_h1[4:0]				
Reset	–	–	–					
Access Type	–	–	–	Read Only				

BITFIELD	BITS	DESCRIPTION
nv_vcom_h1	4:0	Delta VCOM at VTEMP_H1. This value sets the difference between the VCOM value at 25°C and that at VTEMP_H1.

NV_VCOM_H2 (0x1C)

BIT	7	6	5	4	3	2	1	0
Field	–	–	–	nv_vcom_h2[4:0]				
Reset	–	–	–					
Access Type	–	–	–	Read Only				

BITFIELD	BITS	DESCRIPTION
nv_vcom_h2	4:0	Delta VCOM at VTEMP_H2. This value sets the difference between the VCOM value at VTEMP_H1 and that at VTEMP_H2.

NV_VTEMP25 (0x1D)

BIT	7	6	5	4	3	2	1	0
Field	nv_vtemp25[7:0]							
Reset								
Access Type	Read Only							

BITFIELD	BITS	DESCRIPTION
nv_vtemp25	7:0	Voltage at TEMP pin at 25°C.

NV_VTEMP_L (0x1E)

BIT	7	6	5	4	3	2	1	0
Field	nv_vtemp_l[7:0]							
Reset								
Access Type	Read Only							

BITFIELD	BITS	DESCRIPTION
nv_vtemp_l	7:0	Voltage at TEMP pin corresponding to low-temperature breakpoint in VCOM compensation curve.

NV_TEMP_H1 (0x1F)

BIT	7	6	5	4	3	2	1	0
Field	nv_vtemp_h1[7:0]							
Reset								
Access Type	Read Only							

BITFIELD	BITS	DESCRIPTION
nv_vtemp_h1	7:0	Voltage at TEMP pin corresponding to first high-temperature breakpoint in VCOM compensation curve.

NV_TEMP_H2 (0x20)

BIT	7	6	5	4	3	2	1	0
Field	nv_vtemp_h2[7:0]							
Reset								
Access Type	Read Only							

BITFIELD	BITS	DESCRIPTION
nv_vtemp_h2	7:0	Voltage at TEMP pin corresponding to second high-temperature breakpoint in VCOM compensation curve.

NV_VCOM_MIN (0x21)

BIT	7	6	5	4	3	2	1	0
Field	nv_vcom_min[7:0]							
Reset								
Access Type	Read Only							

BITFIELD	BITS	DESCRIPTION
nv_vcom_min	7:0	Lower limit for VCOM setting.

NV_VCOM_MAX (0x22)

BIT	7	6	5	4	3	2	1	0
Field	nv_vcom_max[7:0]							
Reset								
Access Type	Read Only							

BITFIELD	BITS	DESCRIPTION
nv_vcom_max	7:0	Upper limit for VCOM setting.

NV_AVDD_SET (0x23)

BIT	7	6	5	4	3	2	1	0
Field	–	–	nv_avdd[5:0]					
Reset	–	–						
Access Type	–	–	Read Only					

BITFIELD	BITS	DESCRIPTION
nv_avdd	5:0	Sets AVDD and NAVDD voltages. See table for register 0x13.

NV_VGON (0x24)

BIT	7	6	5	4	3	2	1	0
Field	–	nv_cp_2stage	nv_vgon[5:0]					
Reset	–							
Access Type	–	Read Only	Read Only					

BITFIELD	BITS	DESCRIPTION
nv_cp_2stage	6	When this bit is set to 1 a two-stage charge-pump is used.
nv_vgon	5:0	Sets VG _{ON} voltage. See table for register 0x14.

NV_VGOFF (0x25)

BIT	7	6	5	4	3	2	1	0
Field	–	–	nv_vgoff[5:0]					
Reset	–	–						
Access Type	–	–	Read Only					

BITFIELD	BITS	DESCRIPTION
nv_vgoff	5:0	Sets VGOFF voltage. See table for register 0x15.

burn_otp_reg (0x78)

BIT	7	6	5	4	3	2	1	0
Field	burn_otp[7:0]							
Reset	0x0							
Access Type	Write Only							

BITFIELD	BITS	DESCRIPTION
burn_otp	7:0	Command to copy the contents of registers 0x07-0x15 to the non-volatile registers 0x17-0x25.

reboot_otp_reg (0x79)

BIT	7	6	5	4	3	2	1	0
Field	reboot_otp[7:0]							
Reset								
Access Type	Write Only							

BITFIELD	BITS	DESCRIPTION
reboot_otp	7:0	Command to copy the contents of the non-volatile registers 0x17-0x15 to the working registers 0x17-0x25.

soft_restart (0x7A)

BIT	7	6	5	4	3	2	1	0
Field	soft_restart[7:0]							
Reset	0x00							
Access Type	Write Only							

BITFIELD	BITS	DESCRIPTION
soft_restart	7:0	Command used to re-start the device from a latched fault mode. All faults are cleared when this command is executed.

Applications Information

Boost Converter

Boost Converter Inductor Selection

Three key inductor parameters must be specified for operation with the device: Inductance value (L), inductor saturation current (I_{SAT}), and DC resistance (R_{DC}). To determine the inductance value, first select the ratio of inductor peak-to-peak ripple current to average output current (LIR). Higher LIR values mean higher RMS inductor current and therefore higher I^2R losses. To achieve a lower LIR value, a high-valued inductor, which may be physically larger, must be used. A good compromise between size and loss is to select a 30% to 60% peak-to-peak ripple current to average-current ratio (LIR from 0.3 to 0.6). If extremely thin high-resistance inductors are used, as is common for LCD-panel applications, the best LIR may lie between 0.5 and 1.0. The value of the inductor is determined below.

$$L = \frac{V_{IN} \times D}{LIR \times I_{IN} \times f_{SW}}$$

using:

$$I_{IN} = \frac{V_{OUT} \times I_{OUT}}{\eta \times V_{IN}}$$

$$D = 1 - \frac{V_{IN}}{V_{OUT}}$$

where V_{IN} is the input voltage, V_{OUT} is the output voltage, I_{OUT} is the output current, I_{IN} is the calculated average boost input current, η is the efficiency of the boost converter, D is the duty cycle, and f_{SW} is either 420kHz or 2.1MHz (the selected switching frequency of the boost converter). The efficiency of the boost converter can be estimated from the *Typical Operating Characteristics* and accounts for losses in the internal switch, inductor, and capacitors.

The inductor's saturation rating must exceed the maximum current-limit of 2.3A.

Boost Output Filter Capacitor Selection

The primary criterion for selecting the output filter capacitor is low effective series resistance (ESR). The product of the peak inductor current and the output filter capacitor's ESR determine the amplitude of the high-frequency ripple seen on the output voltage. For stability, the boost output-filter capacitor should have a value of 10 μ F or greater when using 2.1MHz switching.

To avoid a large drop on HVINP when AVDD is enabled, the capacitance on the HVINP node should be at least three times larger than that on AVDD.

Boost Input Filter Capacitor

Sufficient input capacitance must be used to avoid input voltage drop when transients are encountered on the AVDD or NAVDD outputs and when the AVDD switch is closed. If the IN voltage drops below 2.57V, the device is likely to reset so input capacitance must prevent this. The total value of capacitance depends on the expected transients and the series resistance in the IN connection. A good starting point is a total input capacitance of 2 x 22 μ F ceramic capacitors in parallel with 2 x 10 μ F ceramic capacitors. Depending on the particular application circumstances more or less capacitance may be needed.

Input capacitance requirements are significantly relaxed when an input voltage of 5V is used.

Setting the AVDD Voltage

The AVDD output voltage is set by writing a 6-bit value to the AVDD_SET register.

The NAVDD converter outputs a negative voltage whose absolute value is the same as AVDD.

NAVDD Inverting Regulator

NAVDD Regulator Inductor Selection

The inductor value for the NEG regulator can be selected using the formula below.

$$L = \frac{V_{\text{NAVDD}} \times (1 - D)}{\text{LIR} \times I_{\text{NAVDD}} \times f_{\text{SW}}}$$

where V_{NAVDD} is the output voltage, I_{NAVDD} the output current, LIR the desired inductor ripple ratio, and f_{SW} the switching frequency.

Calculate the duty-cycle D using:

$$D = \frac{V_{\text{NAVDD}}}{V_{\text{IN}} + V_{\text{NAVDD}}}$$

The inductor's saturation current rating must exceed the maximum current-limit of 2.25A.

NAVDD External Diode Selection

Select a diode with a peak current rating of at least the LXN current limit (I_{LIMNH}) for use with the NAVDD output. The diode breakdown-voltage rating should exceed the sum of the maximum INN voltage and the absolute value of the NAVDD voltage. A Schottky diode improves the overall efficiency of the converter but should be selected to have low leakage at the maximum operating temperature.

NAVDD Output Capacitor Selection

The primary criterion for selecting the output filter capacitor is low ESR and capacitance value, as the NAVDD capacitor provides the load current when the internal switch is on. The voltage ripple on the NAVDD output has two components:

1. Ripple to due ESR which is the product of the peak inductor current and the output filter capacitor's ESR
2. Ripple due to bulk capacitance that can be determined as follows.

$$\Delta V_{\text{BULK}} = \frac{I_{\text{NAVDD}} \times \frac{D}{f_{\text{SW}}}}{C_{\text{NAVDD}}}$$

For stability, the NAVDD output capacitor should have a value of 10 μ F or greater when using 2.1MHz switching frequency.

Setting the V_{GO_N} and V_{GO_{FF}} Output Voltages

The internal positive charge pump can output a voltage approximately three times AVDD. If a voltage of twice the HVINP voltage is sufficient leave the FC1+ and FC1- pins unconnected and set the cp_2stage bit.

For V_{GO_{FF}}, the number of charge-pump stages should be chosen to ensure sufficient output voltage while maintaining the V_{GO_{FF}} voltage within its permitted operating range.

The V_{GO_N} output voltage is set by writing a 6-bit value to the vgon[5:0] field in the V_{GO_N} register.

The V_{GO_{FF}} voltage is set by writing a 6-bit value to the vgo[5:0] field in the V_{GO_{FF}} register.

VCOM Block**VCB Transistor**

Select an external npn transistor with a minimum current gain of 30. When designing the PCB, ensure that the parasitic capacitance between the base and collector of the npn is minimized to avoid oscillation. Note that high continuous DC current on VCOM causes very high power dissipation in the npn device and a device with low thermal resistance should therefore be selected.

VCOM Temperature Compensation Example

Assume that an NTC with 10k Ω resistance at 25 $^{\circ}$ C is connected from TEMP to GND and that the R_{REF} resistor is of value 2400 Ω . At various temperatures, the following voltages will be observed on R_{REF} and the ADC measurement result

will be as follows:

Table 5. ADC Result vs Temperature

TEMPERATURE	NTC RESISTANCE	R _{REF} VOLTAGE	ADC RESULT	DESIRED VCOM VOLTAGE
-30°C	113kΩ	13mV	0x02	-1.09V
25°C	10kΩ	150mV	0x1F	-1V
60°C	3kΩ	500mV	0x66	-0.98V
85°C	1.5kΩ	1V	0xCD	-0.91V

The rightmost column of the previous table indicates the desired VCOM output voltage at each temperature, which will be the inflection points in the temperature compensation curve. The following values are written to the relevant registers (remembering that each LSB of the VCOM setting represents 6.83mV):

Table 6. VCOM Setting Example

REGISTER	FIELD	SETTING	NOTES
DELAYVCOM_LSB[7:0]	vcom25_0	0	9-bit value is 011011010 or 0xDA which corresponds to -1V
VCOM25	vcom25[7:0]	0x6D	
VCOM_L	vcom_l[4:0]	0x0D	Represents shift of -89mV from VCOM25
VCOM_H1	vcom_h1[4:0]	0x03	Represents shift of +20mV from VCOM25
VCOM_H2	vcom_h2[4:0]	0x0A	Represents shift of +68mV from VCOM_H1
VTEMP25	vtemp25[7:0]	0x1F	ADC result at 25°C
VTEMP_L	vtemp_l[7:0]	0x02	ADC result at -30°C
VTEMP_H1	vtemp_h1[7:0]	0x66	ADC result at 60°C
VTEMP_H2	vtemp_h2[7:0]	0xCD	ADC result at 85°C

With these settings, the VCOM output voltage at 25°C is -1V, while at the temperature represented by 13mV at the R_{REF} pin the VCOM voltage decreases to -1.09V as set by the VCOM_L register. Similarly, the VCOM_H1 and VCOM_H2 values are output on VCOM when the TEMP voltage is 500mV and 1V, respectively. In between these values the device interpolates the correct VCOM voltage value with a resolution of 6.83mV. The complete curve is shown in [Figure 4](#).

When setting the values VTEMP_{xx} and VCOM_{xx}, it is important to avoid values which can cause wraparound in the temperature compensation algorithm thus possibly leading to sudden changes in the value of VCOM.

Sample VCOM Temperature Compensation Curve

Figure 4. Sample VCOM Temperature Compensation Curve

Using the NV Memory

Follow the sequence below to perform non-volatile programming of the device when the auto-refresh function is not used:

1. Apply a voltage between 3.3V and 5V to the IN and INN pins with the device in I²C mode
2. Write the desired values to be stored in OTP to the registers from 0x07 to 0x15
3. Apply 8.5V to V_{PROG}
4. Optionally wait to ensure the 8.5V at V_{PROG} is stable
5. Send burn_otp_reg (write any value to 0x78) command. If parity is enabled ensure the overall parity is even by altering the final byte if necessary.
6. Wait 20ms
7. If the nv_fit bit is 0, the write was successful, go to next step. If nv_fit = 1, perform re-try (steps 5,6).
8. Send reboot_otp (write any value to 0x79) command.

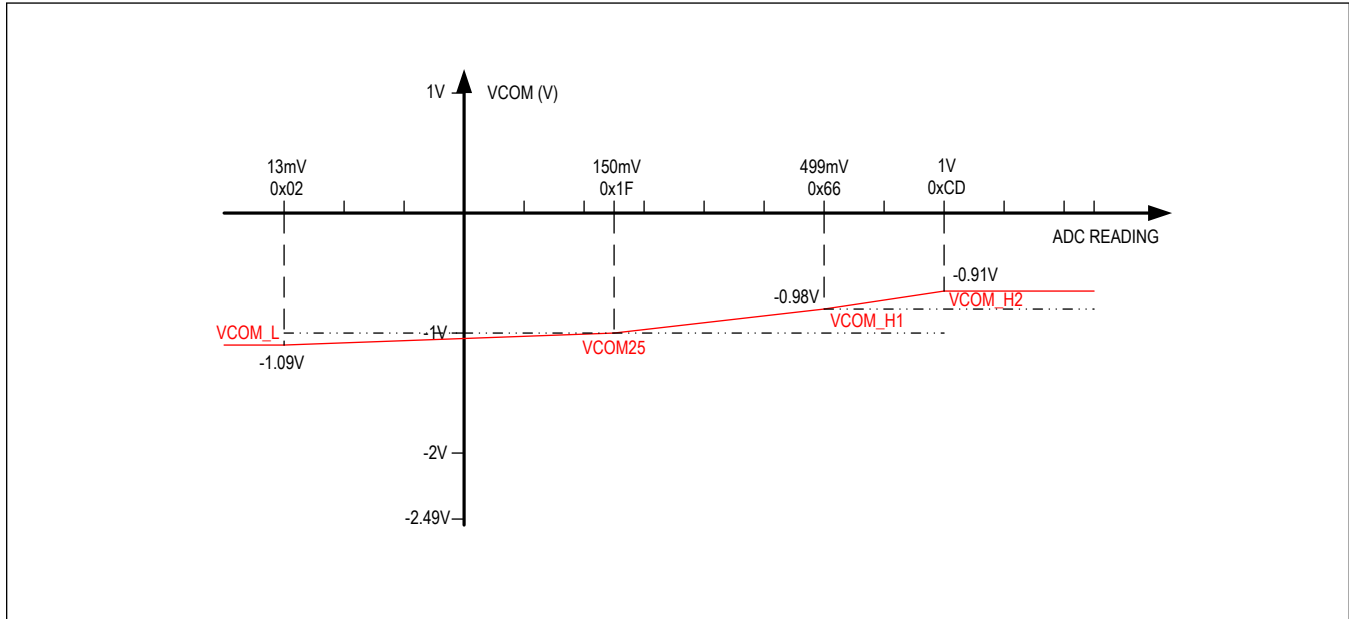
Special care is required when performing non-volatile programming with the auto-refresh feature enabled. In such cases follow the sequence below when at least one calibration has already been performed:

1. Apply a voltage between 3.3V and 5V to the IN and INN pins
2. Write the desired values to be stored in NV memory to the registers from 0x07 to 0x15 (keep auto-refresh bit disabled until here)
3. Enable the auto-refresh feature
4. Start polling one of the registers from 0x07 to 0x15 which has changed its value until that value gets refreshed to the older one (auto-refresh is active)
5. The following steps from #6 to #10 must be completed within 1s
6. Write the desired values to be stored in OTP to the registers from 0x07 to 0x15 (including auto-refresh bit).
7. Apply 8.5V to V_{PROG}
8. Optionally wait to ensure the 8.5V at V_{PROG} is stable

9. Send `burn_otp_reg` (write any value to 0x78) command. If parity is enabled ensure the overall parity is even by altering the final byte if necessary
10. Wait 20ms
11. If the `nv_fit` bit is 0, the write was successful, go to next step. If `nv_fit` = 1, perform retry from step 2.
12. Send `reboot_otp` (write any value to 0x79) command

The non-volatile memory can be written to a total of 5 times.

Layout Considerations

The MAX25222 uses high-frequency switching converters to generate the voltages for TFT-LCDs. Take proper care while laying out the circuit board to ensure correct operation. The switching-converter portions of the circuit have nodes with very fast voltage changes that could lead to undesirable effects on the sensitive parts of the circuit as well as electromagnetic interference (EMI). Follow the guidelines below to reduce noise as much as possible:

- Connect the bypass capacitors on IN and INN as close as possible to the device and connect the capacitor ground to the analog ground plane using vias close to the capacitor terminal. Ensure that the power connection to IN and INN uses a very wide trace or complete board layer to avoid input undervoltage problems.
- Connect the GND pin of the device to the analog ground plane using a via close to GND. Lay the analog ground plane on the inner layer, preferably next to the top layer. Use the analog ground plane to cover the entire area under critical signal components for the power converter.
- Have a power-ground plane for the switching-converter power circuit under the power components (i.e., input filter capacitor, output filter capacitor, inductor, MOSFET, rectifier diode, and current-sense resistor). Connect PGND to the power-ground plane closest to PGND. Connect all other ground connections to the power ground plane using vias close to the terminals.
- Minimize the copper area of all switching nodes to avoid EMI. Minimize the loop areas for the AVDD and NAVDD converters by placing all components close to the LXP and LXN pins. Place the input and output capacitor grounds close to each other. In the case of AVDD the input/output capacitor grounds should also connect directly to the PGND pin.
- Connect GND, CPGND and PGND at the exposed pad of the device.
- Refer to the MAX25222 evaluation kit (EV kit) data sheet for a sample layout.

In addition, when using an external NTC temperature sensor for temperature compensation connect the grounded end directly to the grounded end of the RREF resistor. This avoids possible differences in ground potential between different points on the circuit board.

Typical Application Circuits

Applications Diagram

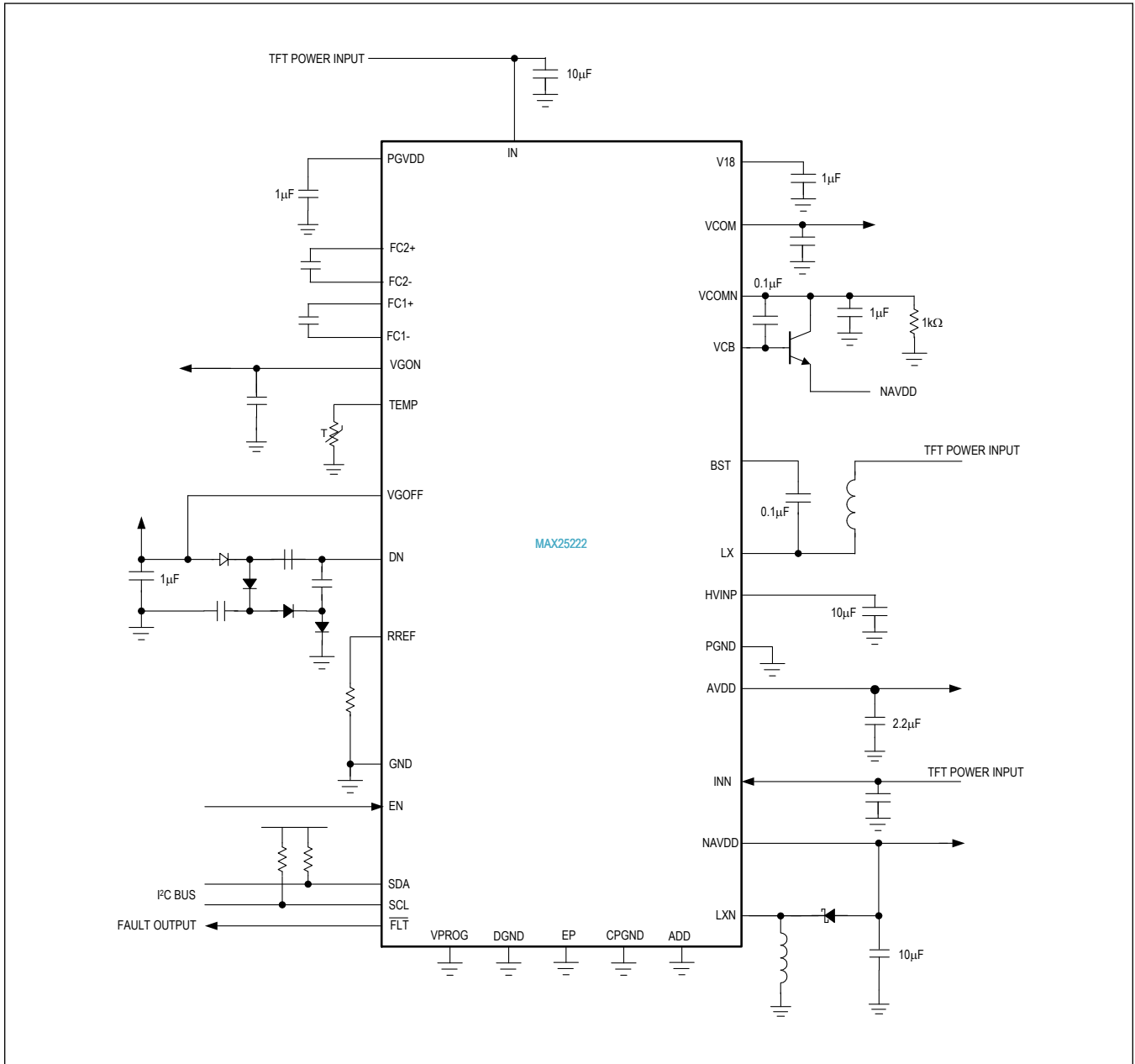

Ordering Information

Part Number	Temp Range	Pin-Package	Features
MAX25222ATJ/V+	-40 to +125°C	32 TQFN-EP	ASIL device with VCOM buffer
MAX25222ATJ/VY+*	-40 to +125°C	32 SWTQFN-EP	ASIL device with VCOM buffer

+ Denotes a lead(Pb)-free/RoHS-compliant package.

/V denotes an automotive qualified part.

Y = Side-wettable package.

T Denotes tape-and-reel.

*Future product - contact factory for availability.

MAX25222

Automotive 4-Channel TFT-LCD Power Supply
with VCOM Buffer and ASIL B Features

Revision History

REVISION NUMBER	REVISION DATE	DESCRIPTION	PAGES CHANGED
0	9/20	Initial release	—

For pricing, delivery, and ordering information, please visit Maxim Integrated's online storefront at <https://www.maximintegrated.com/en/storefront/storefront.html>.

Maxim Integrated cannot assume responsibility for use of any circuitry other than circuitry entirely embodied in a Maxim Integrated product. No circuit patent licenses are implied. Maxim Integrated reserves the right to change the circuitry and specifications without notice at any time. The parametric values (min and max limits) shown in the Electrical Characteristics table are guaranteed. Other parametric values quoted in this data sheet are provided for guidance.