



MAX19541/MAX19542 Evaluation Kits

General Description

The MAX19541/MAX19542 evaluation kits (EV kits) are fully assembled and tested printed-circuit boards (PCBs) that contain all the components necessary to evaluate the performance of the MAX19541 (125MSPS) and MAX19541/MAX19542 (170MSPS) 12-bit analog-to-digital converters (ADCs). The MAX19541/MAX19542 accept differential analog inputs; however, the EV kits generate this signal from a user-provided, single-ended signal source. The digital outputs produced by the ADC are CMOS compatible and can be easily captured with a user-provided, high-speed logic analyzer or data-acquisition system. The EV kits operate from 1.8V and 3.3V power supplies and include circuitry that generates a clock signal from a user-provided AC signal.

Features

- ◆ Up to 170MSPS Sampling Rate Using the MAX19542
- ◆ Up to 125MSPS Sampling Rate Using the MAX19541
- ◆ Low-Voltage and Low-Power Operation
- ◆ Fully Differential Input Signal Configuration
- ◆ On-Board Output Buffers
- ◆ Fully Assembled and Tested

Ordering Information

PART	TEMP RANGE	IC PACKAGE
MAX19541EVKIT+	0°C to +70°C*	68 QFN-EP**
MAX19542EVKIT+	0°C to +70°C*	68 QFN-EP**

+Denotes a lead-free and RoHS-compliant EV kit.

*This limited temperature range applies to the EV kit PCB only. The MAX19541/MAX19542 IC temperature range is -40°C to +85°C.

**EP = Exposed paddle.

Component List

DESIGNATION	QTY	DESCRIPTION
C1, C2, C3, C5–C27	26	0.1μF ±10%, 10V X5R ceramic capacitors (0402) TDK C1005X5R1A104K
C4	0	Not installed, ceramic capacitor (0402)
C28, C29, C30	3	0.22μF ±10%, 6.3V X5R ceramic capacitors (0402) TDK C1005X5R0J224K
C31–C34	4	47μF ±10%, 10V tantalum capacitors (C case) AVX TAJC476K010
C35–C38	4	10μF ±20%, 6.3V X5R ceramic capacitors (0805) TDK C2012X5R0J106M
C39–C42	4	1.0μF ±10%, 10V X5R ceramic capacitors (0603) TDK C1608X5R1A105K
C43	1	0.01μF ±20%, 25V X7R ceramic capacitor (0402) TDK C1005X7R1E103M
C44, C45	0	Not installed, shorted by PC trace (0603)

INP, CLK, RESET	3	SMA PC board vertical-mount connectors
INN	0	Not installed, vertical-mount SMA connector
J1, J2	2	Dual-row 40-pin headers
JU1–JU6, JU8	7	3-pin headers
JU7	1	Dual-row 8-pin header
R1, R2, R11, R12, R14, R15, R22	0	Not installed, resistors (0603)
R3–R7	5	49.9Ω ±1% resistors (0603)
R8, R9	2	510Ω ±5% resistors (0603)
R10, R13	2	0Ω resistors (0603)
R16, R17	2	24.9Ω ±0.1% resistors (0603) IRC PFC-W0603RLF-02-24R9-B Panasonic ERA3HB24R9V
R18, R19	2	24.9Ω ±1% resistors (0603)
R20	1	100kΩ, 12-turn, 1/4in potentiometer
R21	1	13kΩ ±1% resistor (0603)
R23–R26	0	Not installed, shorted by PC trace (0603)

Evaluate: MAX19541/MAX19542

MAX19541/MAX19542 Evaluation Kits

Component List (continued)

DESIGNATION	QTY	DESCRIPTION
RA1–RA4	4	100Ω ±5% resistor arrays (1206) Panasonic EXB-2HV-101J
RA5–RA8	4	22Ω ±5% resistor arrays (1206) Panasonic EXB-2HV-220J
T1, T2	2	1:1 800MHz RF transformers Mini-Circuits ADT1-1WT+
TP1, TP2, TP3	3	Test points (black)
U1	1	See the <i>EV Kit-Specific Component List</i>
U2	1	3.3V ECL differential receiver (8-pin SO) ON Semiconductor MC100LVEL16DG

DESIGNATION	QTY	DESCRIPTION
U3, U4	2	Low-voltage, 16-bit flip-flops (48-pin TSSOP) Pericom PI74ALVTC16374AE
U5	1	Dual two-input exclusive-OR gate (8-pin VSSOP) TI SN74AUC2G86DCURE4
—	1	PCB: MAX19541/MAX19542 Evaluation Kit+

EV Kit-Specific Component list

EV KIT PART NUMBER	REFERENCE DESIGNATOR	DESCRIPTION
MAX19541EVKIT+	U1	MAX19541EGK+ (68-pin QFN with EP, 10mm x 10mm x 0.9mm)
MAX19542EVKIT+		MAX19542EGK+ (68-pin QFN with EP, 10mm x 10mm x 0.9mm)

Component Suppliers

SUPPLIER	PHONE	FAX	WEBSITE
AVX Corp.	843-946-0238	843-626-3123	www.avxcorp.com
IRC, Inc.	361-992-7900	361-992-3377	www.irctt.com
Panasonic Corp.	714-373-7183	714-373-7939	www.panasonic.com
TDK Corp.	847-803-6100	847-390-4405	www.component.tdk.com

Note: Indicate that you are using the MAX19541/MAX19542 when contacting these component suppliers.

Quick Start

Recommended Equipment

- DC power supplies:

Analog (AVCC)	1.8V, 1A
Clock (CVCC)	3.3V, 500mA
Buffers (BVCC)	1.8V, 500mA
Digital (OVCC)	1.8V, 1A
- Signal generator with low phase noise for clock input signal (e.g., HP 8662A, HP 8644B)
- Signal generator for analog input signal (e.g., HP 8662A, HP 8644B)

- Logic analyzer or data-acquisition system (e.g., HP 16500C with high-speed state card such as the HP 16517A)
- Digital voltmeter

Procedure

The MAX19541/MAX19542 EV kits are fully assembled and tested surface-mount boards. Follow the steps below for board operation. **Caution: Do not turn on power supplies or enable signal generators until all connections are completed:**

- Verify that shunts are installed in the following locations:
 - JU1 (1-2)—Divide-by-two disabled
 - JU2 (2-3)—Parallel mode selected

MAX19541/MAX19542 Evaluation Kits

Evaluate: MAX19541/MAX19542

- c) JU3 (2-3)—Demux parallel mode selected if JU2 is pulled high
 - d) JU4 (2-3)—Two's-complement output selected
 - e) JU5 (1-2)—Noninverted DCLKP selected
 - f) JU6 (2-3)—Noninverted DCLKN selected
 - g) JU7 (3-4)—Internal reference enabled
- 2) Connect the clock signal generator to the SMA connector labeled CLK.
 - 3) Connect the analog input signal generator to the SMA connector labeled INP.
 - 4) Connect the logic analyzer's high-speed state card probe connectors to header J1 (CMOS-compatible signals); see Table 5 for header connections.
 - 5) Connect a 1.8V, 1A power supply to AVCC. Connect the ground terminal of this supply to the GND pad closest to the AVCC pad.
 - 6) Connect a 3.3V, 500mA power supply to CVCC. Connect the ground terminal of this supply to the GND pad closest to the CVCC pad.
 - 7) Connect a 1.8V, 500mA power supply to BVCC. Connect the ground terminal of this supply to the GND pad closest to the BVCC pad.
 - 8) Connect a 1.8V, 1A power supply to OVCC. Connect the ground terminal of this supply to the GND pad closest to the OVCC pad.
 - 9) Turn on all the power supplies.
 - 10) Enable the signal generators. Set the clock signal generator to output a 170MHz signal, with a 2.4V_{P-P} amplitude. Set the analog input signal generator to output the desired frequency with an amplitude $\leq 2V_{P-P}$. For coherent sampling, the signal generators should be synchronized.
 - 11) Enable the logic analyzer.
 - 12) Collect data using the logic analyzer.

Detailed Description

The MAX19541/MAX19542 EV kits are fully assembled and tested PCBs that contain all the components necessary to evaluate the performance of the MAX19541/MAX19542. The MAX19541/MAX19542 can be evaluated with a maximum clock frequency (f_{CLK}) of 170MHz.

The MAX19541/MAX19542 accept differential inputs. Applications that only have a single-ended signal source available can use the on-board transformer (T2) to convert a single-ended signal to a differential signal.

Output buffers (U3 and U4) buffer the digital output signals of the MAX19541/MAX19542 to higher capacitive

load signals that can be captured by a wide variety of logic analyzers. The buffered CMOS outputs can be accessed at headers J1 and J2.

Each EV kit is designed as a four-layer PCB to optimize the performance of the MAX19541/MAX19542. Separate analog, digital, clock, and buffer power planes minimize noise coupling between analog and digital signals; 50 Ω coplanar transmission lines are used for analog and clock inputs. The trace lengths of the 50 Ω CMOS lines are matched to within a few thousandths of an inch to minimize layout-dependent delays.

Power Supplies

The MAX19541/MAX19542 EV kits require separate analog, digital, clock, and buffer power supplies for best performance. Two separated 1.8V power supplies are used to power the analog and digital portions of the MAX19541/MAX19542. The on-board clock circuitry is powered by another 3.3V power supply, and a 1.8V power supply is used to power the output buffers (U3 and U4) on the EV kits.

Clock

The MAX19541/MAX19542 require a differential clock signal. However, if only a single-ended clock signal source is available, the EV kit's on-board level translator helps to convert a single-ended clock to the required differential signal. An on-board clock-shaping circuit generates a differential clock signal from an AC-coupled sine-wave signal applied to the clock input SMA connector CLK. The input signal amplitude should not exceed 2.6V_{P-P}. The frequency of the clock signal should not exceed 170MHz. The frequency of the sinusoidal input clock signal determines the sampling frequency (f_{CLK}) of the ADC. A differential line receiver (U2) processes the input signal to generate the required clock signal.

Clock Divider

The MAX19541/MAX19542 feature an internal divide-by-two clock divider. Use jumper JU1 to enable/disable this feature. See Table 1 for shunt positions.

Table 1. Clock-Divider Shunt Settings (JU1)

SHUNT POSITION	MAX19541/MAX19542 CLKDIV PIN	DESCRIPTION
1-2*	Connected to AVCC	Clock signal divided by 1
2-3	Connected to GND	Clock signal divided by 2

*Default position.

MAX19541/MAX19542 Evaluation Kits

Input Signal

The MAX19541/MAX19542 accept differential analog input signals. However, the EV kits only require a single-ended analog input signal with an amplitude of less than 2V_{p-p} provided by the user. An on-board transformer then takes the single-ended analog input and generates a differential analog signal, which is applied to the ADC's differential input pins.

Optional Input Transformer

The MAX19541/MAX19542 EV kits use a second transformer to enhance THD and SFDR performance at high input frequencies (>100MHz). This transformer helps to reduce the increase of even-order harmonics at high frequencies. To use only the primary transformer, follow the directions below:

- 1) Remove R10 and R13.
- 2) Install a 0.1 μ F capacitor on C4.
- 3) Install a 0 Ω resistor at R22.
- 4) Install an SMA connector on INN.
- 5) Connect the analog signal source to INN instead of INP.

Table 2. Reference Shunt Settings (JU7)

SHUNT POSITION	DESCRIPTION
1-2	Internal Reference Disabled. Apply an external reference voltage to the REFIO pad.
3-4*	Internal Reference Enabled. REFIO is the output of the internal reference.
5-6	Increases FSR through trim potentiometer R20.
7-8	Decreases FSR through trim potentiometer R20.

*Default position.

Reference Voltage

There are two methods to set the full-scale range of the MAX19541/MAX19542. Both EV kits can be configured to use the MAX19541/MAX19542's internal reference, or a stable, low-noise, external reference can be applied to the REFIO pad. Jumper JU7 controls which reference source is used. See Table 2 for shunt settings.

Output Mode

The MAX19541/MAX19541/MAX19542 feature three modes of operation: parallel mode, demux parallel mode, and demux interleaved mode. In each mode of operation, the digital data is output in a different format and is controlled by the ADC's DEMUX and ITL pins. The EV kits incorporate jumpers JU2 and JU3 to control the DEMUX and ITL pins, respectively. See Table 3 for shunt settings.

Table 3. Output-Mode Shunt Settings (JU2 and JU3)

JU2 SHUNT POSITION	DEMUX PIN	JU3 SHUNT POSITION	ITL PIN	OUTPUT MODE	OUTPUT PORT
2-3	Connected to GND	—	—	Parallel mode	Port A
1-2	Connected to AV _{CC}	2-3	Connected to GND	Demux parallel mode	Ports A and B
1-2	Connected to AV _{CC}	1-2	Connected to AV _{CC}	Demux interleaved mode	Ports A and B

MAX19541/MAX19542 Evaluation Kits

Output Format

The digital output coding can be chosen to be either in two's complement or straight offset-binary format by configuring jumper JU4. See Table 4 for shunt settings.

Output Bit Locations

The buffered digital outputs of the ADC are connected to two 40-pin headers (J1 and J2). PCB trace lengths are matched to minimize output skew and improve performance of the device. The buffers are able to drive large capacitive loads, which may be present at the logic analyzer connection. See Table 5 for headers J1 and J2 bit locations.

Table 4. Output-Format Shunt Settings (JU4)

SHUNT POSITION	\bar{T}/B PIN	DESCRIPTION
1-2	Connected to AVCC	Digital data appears in straight offset-binary code.
2-3*	Connected to GND	Digital data appears in two's-complement code.

Table 5. Output Bit Locations (J1 and J2)

PORT A BIT	BUFFERED OUTPUT	LABEL NAME	PORT B BIT	BUFFERED OUTPUT	LABEL NAME	DESCRIPTION
ORA	J1-35	BORA	ORB	J2-35	BORB	Ovrange bit
DA11	J1-31	BDA11	DB11	J2-31	BDB11	Bit 11 (MSB)
DA10	J1-29	BDA10	DB10	J2-29	BDB10	Bits 10–1
DA9	J1-27	BDA9	DB9	J2-27	BDB9	
DA8	J1-25	BDA8	DB9	J2-25	BDB8	
DA7	J1-23	BDA7	DB7	J2-23	BDB7	
DA6	J1-21	BDA6	DB6	J2-21	BDB6	
DA5	J1-19	BDA5	DB5	J2-19	BDB5	
DA4	J1-17	BDA4	DB4	J2-17	BDB4	
DA3	J1-15	BDA3	DB3	J2-15	BDB3	
DA2	J1-13	BDA2	DB2	J2-13	BDB2	
DA1	J1-11	BDA1	DB1	J2-11	BDB1	
DA0	J1-9	BDA0	DB0	J2-9	BDB0	Bit 0 (LSB)
DCLKP	J1-3	CLKA	DCLKN	J2-3	CLKB	Clock output signal

Evaluate: MAX19541/MAX19542

MAX19541/MAX19542 Evaluation Kits

Evaluate: MAX19541/MAX19542

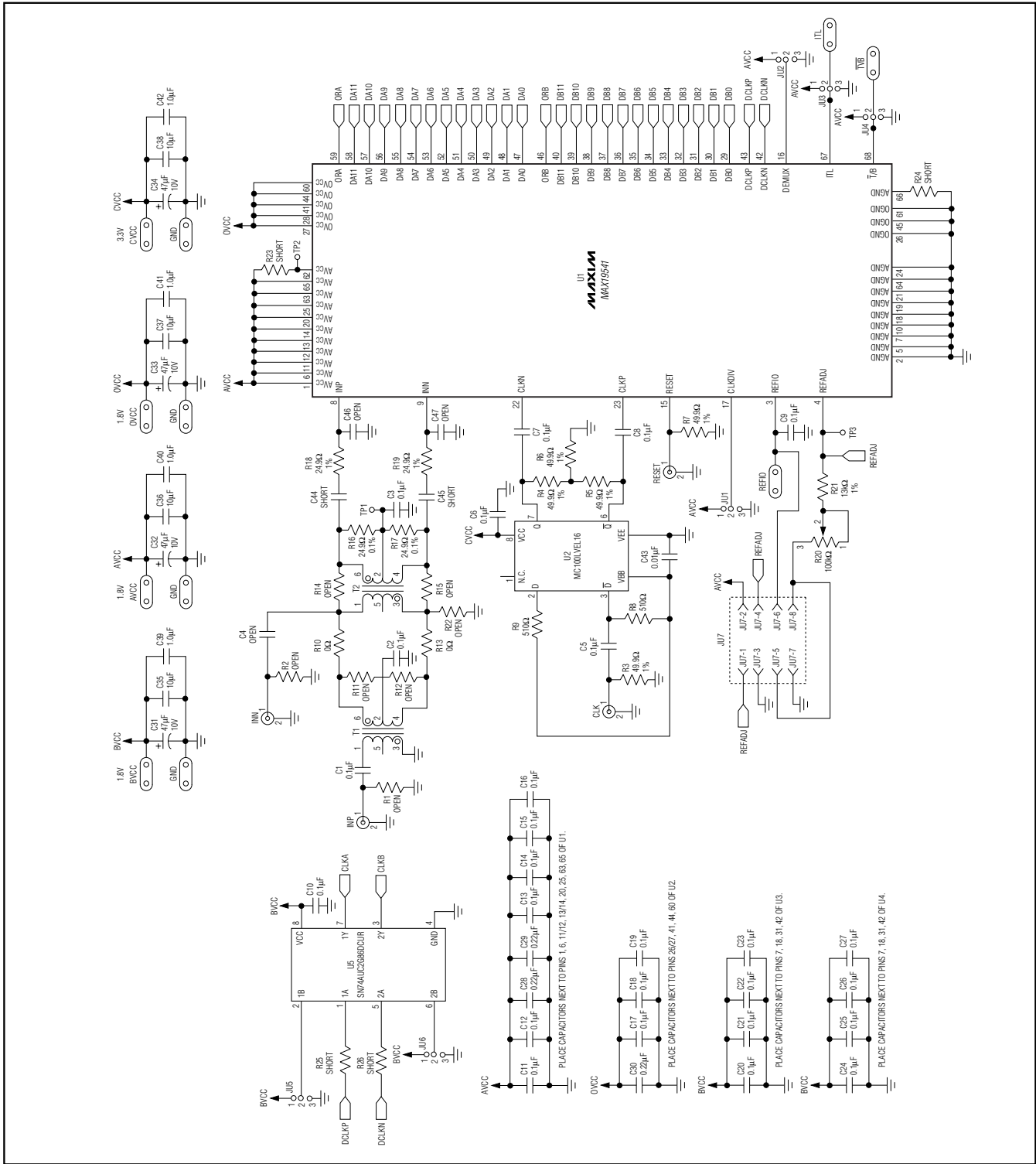

Figure 1a. MAX19541/MAX19542 EV Kits Schematic (Sheet 1 of 3)

MAX19541/MAX19542 Evaluation Kits

Evaluate: MAX19541/MAX19542

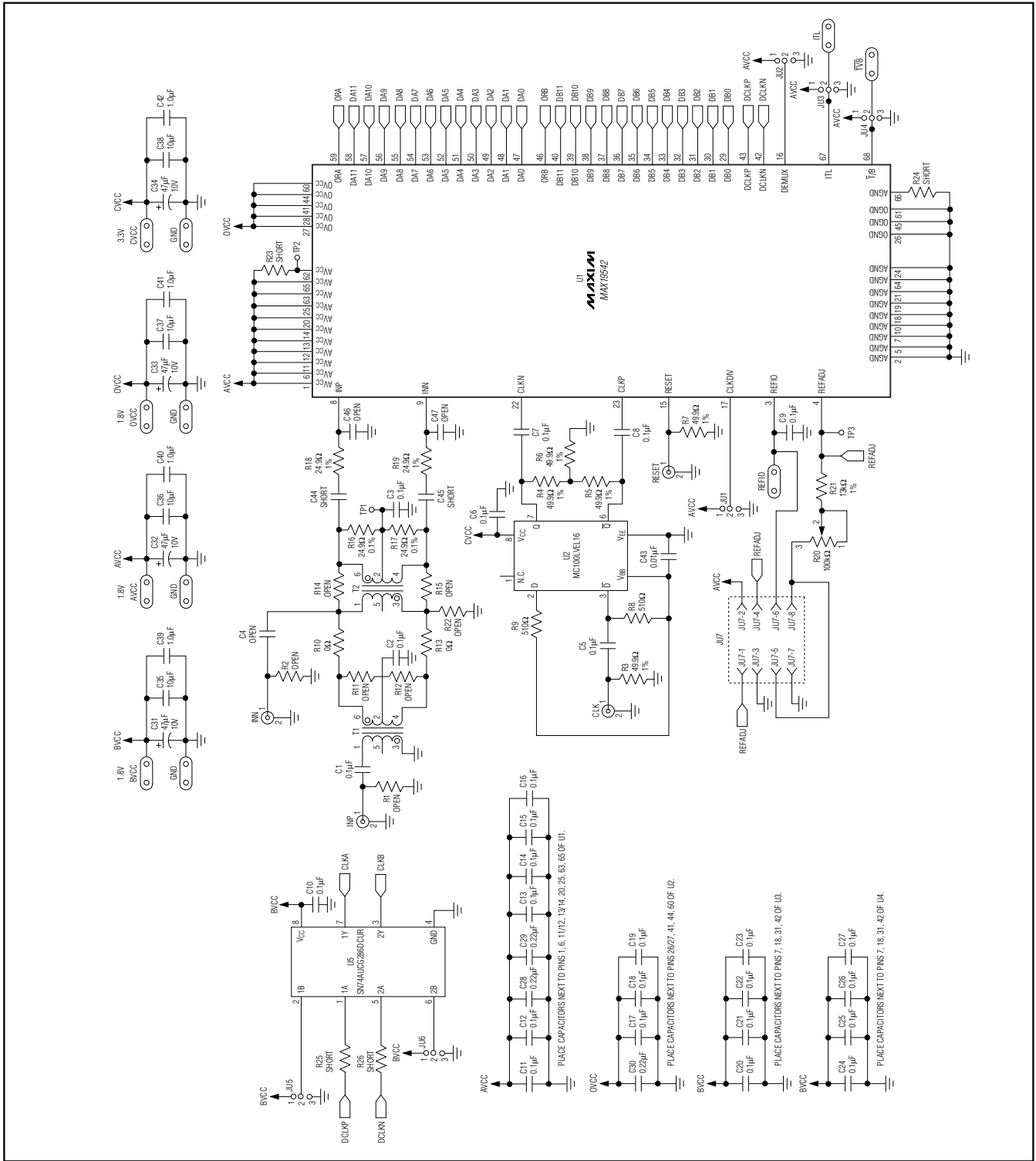

Figure 1b. MAX19541/MAX19542 EV Kits Schematic (Sheet 2 of 3)

MAX19541/MAX19542 Evaluation Kits

Evaluate: MAX19541/MAX19542

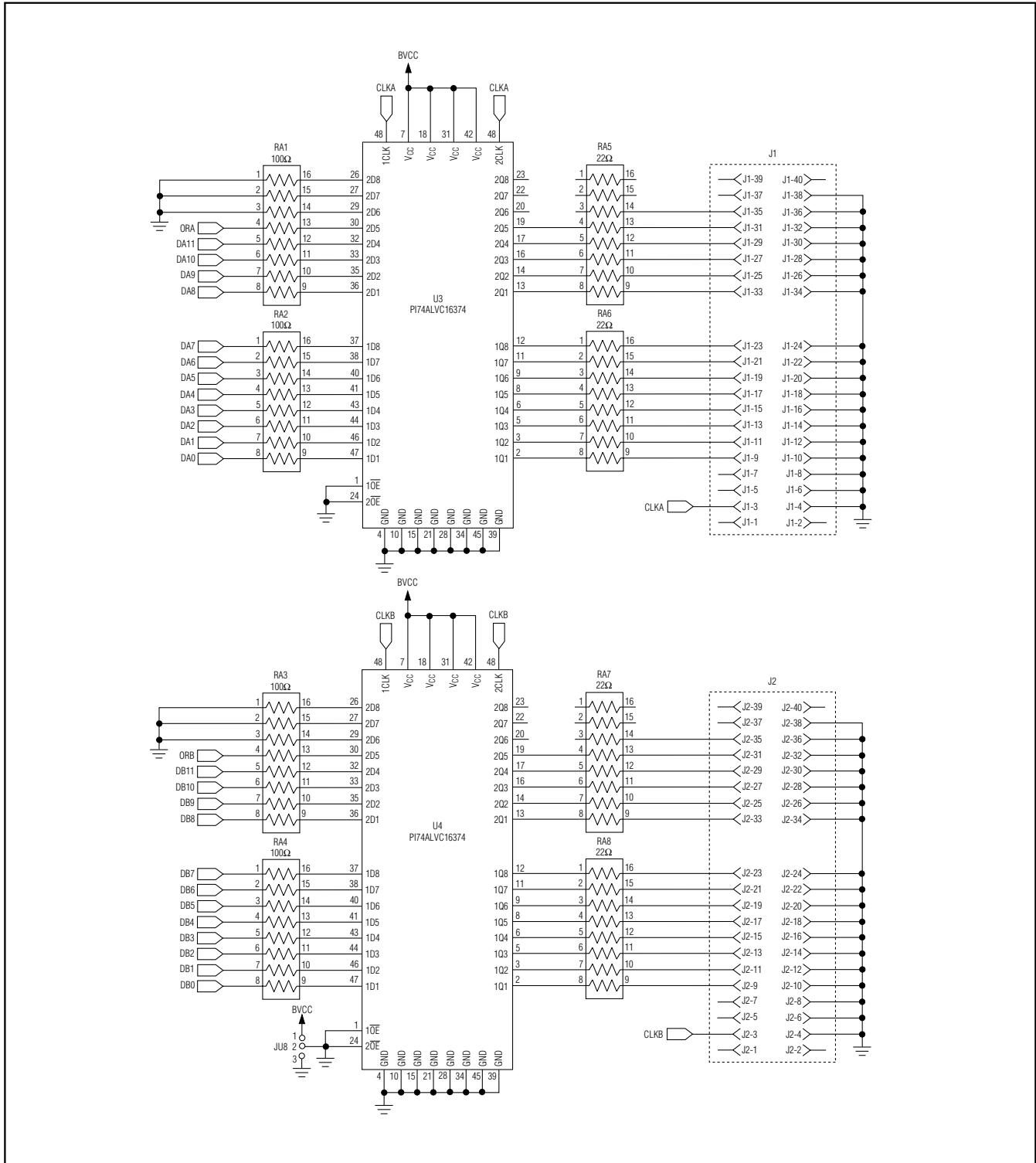

Figure 1c. MAX19541/MAX19542 EV Kits Schematic (Sheet 3 of 3)

MAX19541/MAX19542 Evaluation Kits

Evaluate: MAX19541/MAX19542

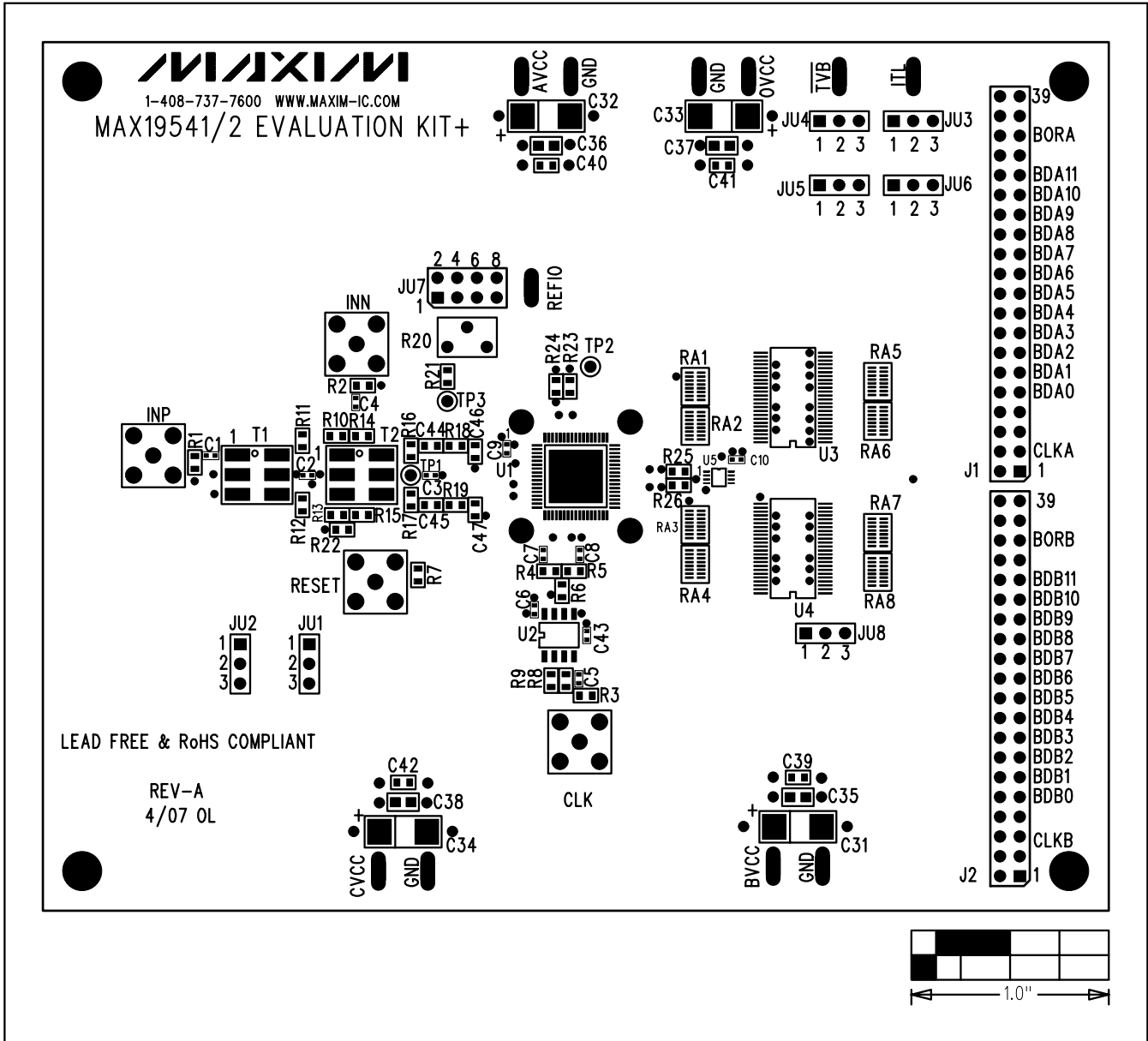

Figure 2. MAX19541/MAX19542 EV Kits Component Placement Guide—Component Side

MAX19541/MAX19542 Evaluation Kits

Evaluate: MAX19541/MAX19542

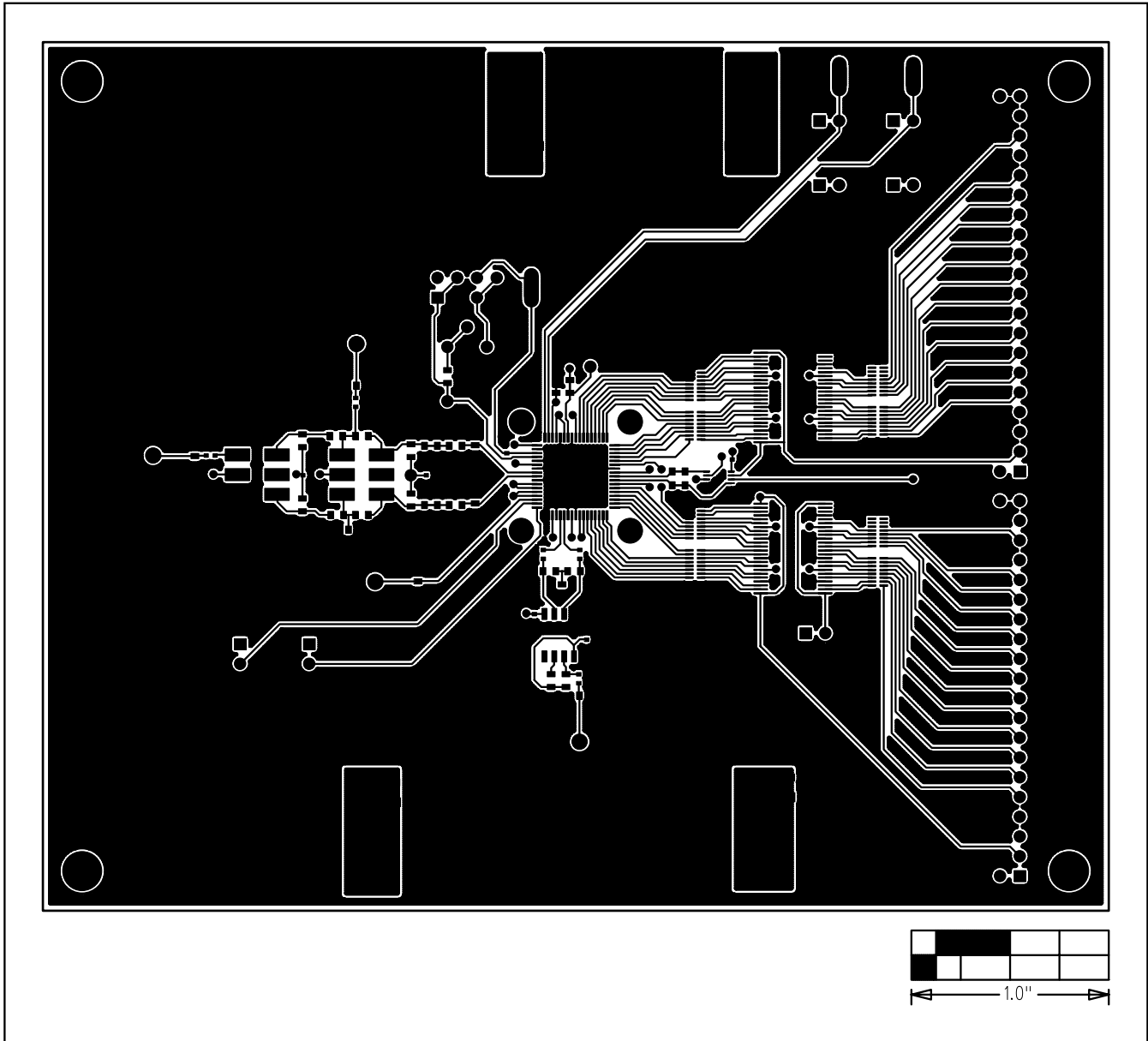

Figure 3. MAX19541/MAX19542 EV Kits PCB Layout—Component Side

MAX19541/MAX19542 Evaluation Kits

Evaluate: MAX19541/MAX19542

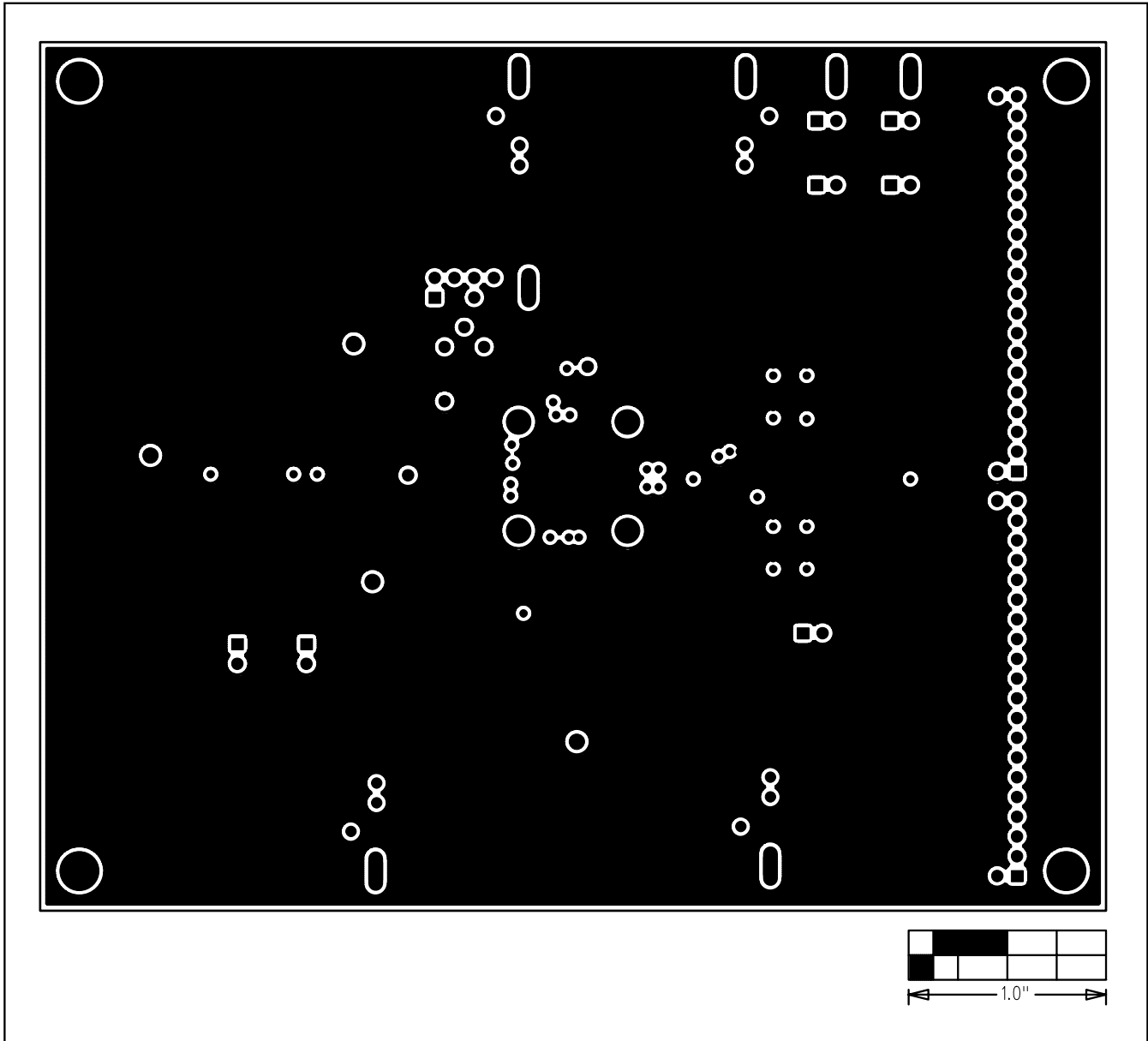

Figure 4. MAX19541/MAX19542 EV Kits PCB Layout—Ground Plane (Inner Layer 2)

MAX19541/MAX19542 Evaluation Kits

Evaluate: MAX19541/MAX19542

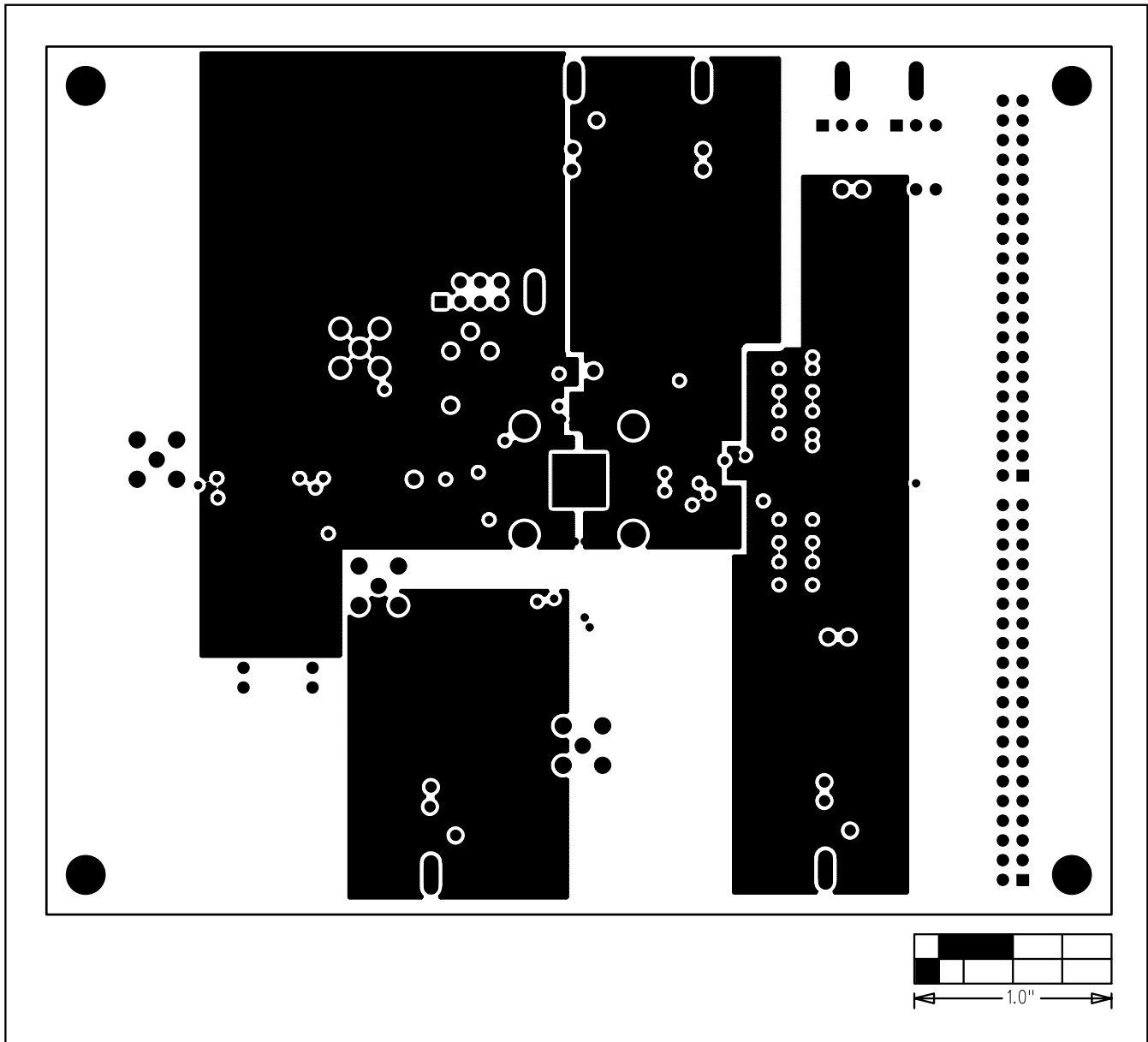

Figure 5. MAX19541/MAX19542 EV Kits PCB Layout—Power Planes (Inner Layer 3)

MAX19541/MAX19542 Evaluation Kits

Evaluate: MAX19541/MAX19542

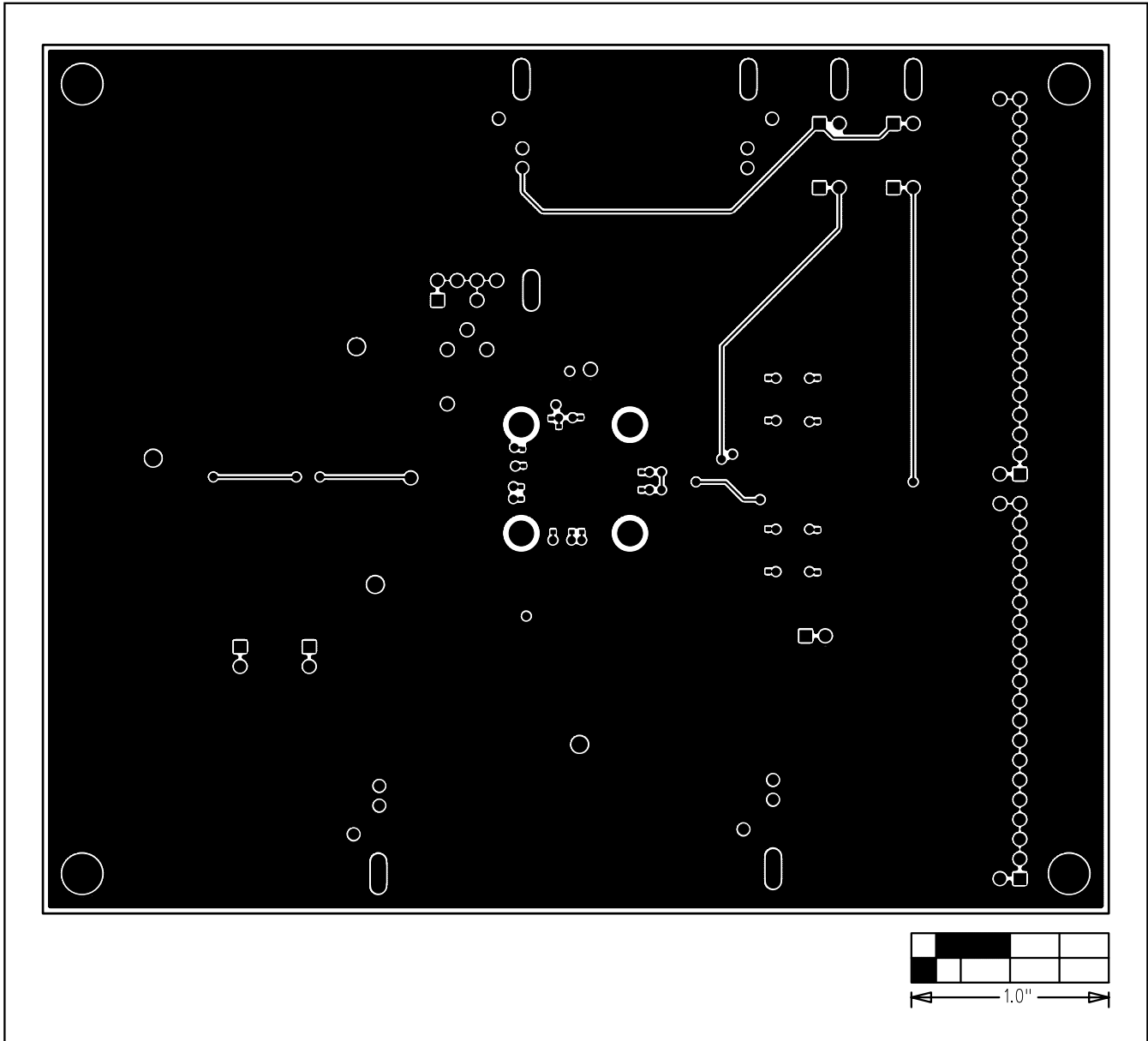

Figure 6. MAX19541/MAX19542 EV Kits PCB Layout—Solder Side

MAX19541/MAX19542 Evaluation Kits

Evaluate: MAX19541/MAX19542

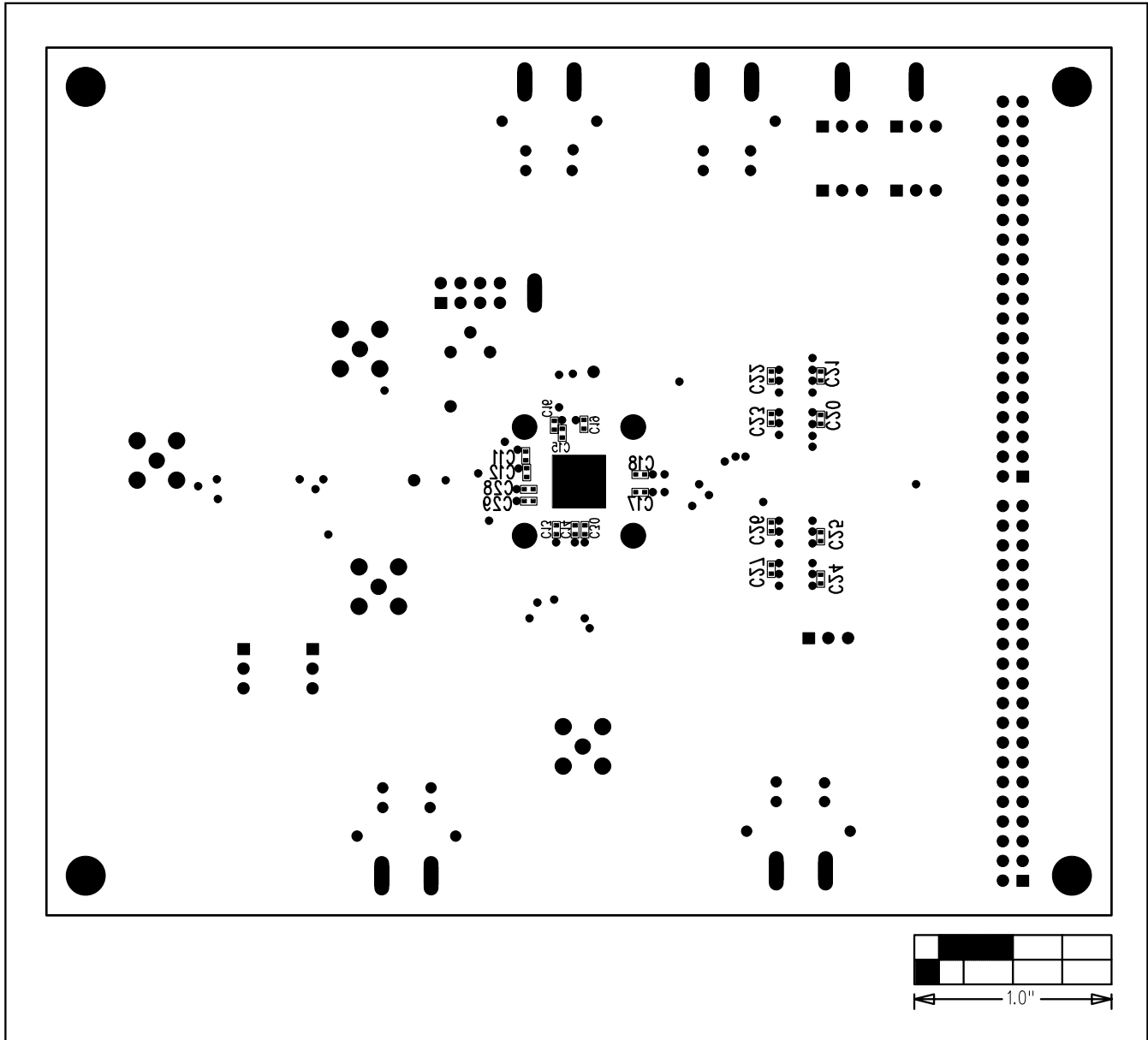

Figure 7. MAX19541/MAX19542 EV Kits Component Placement Guide—Solder Side

Revision History

Pages changed at Rev 1: Title Change—all pages, 1–13

Maxim cannot assume responsibility for use of any circuitry other than circuitry entirely embodied in a Maxim product. No circuit patent licenses are implied. Maxim reserves the right to change the circuitry and specifications without notice at any time.

14 _____ **Maxim Integrated Products, 120 San Gabriel Drive, Sunnyvale, CA 94086 408-737-7600**