

MAX17701EVKITA# Evaluation Kit

Evaluates: MAX17701 in 5V Output-Voltage Application

General Description

The MAX17701EVKITA# (EV kit) provides a proven design to evaluate the MAX17701 high-efficiency, high-voltage, Himalaya synchronous step-down DC-DC supercapacitor charger controller. The EV kit provides constant current (CC) mode and constant voltage (CV) modes to charge supercapacitors. The EV kit is designed to deliver 20A CC mode current (I_{CHGMAX}) and 5V CV mode voltage (V_{OUT}) from a 9V to 60V input supply. The EV kit supports up to continuous 10A load connected in parallel to supercapacitors at the output. The EV kit is optimized for 24V nominal input voltage application. The switching frequency of the EV kit is set at 350kHz (f_{SW}) for optimum efficiency and component size. The EV kit features a safety timer (TMR) to set the maximum allowed constant current (CC) mode charging time. For more details about the IC benefits and features, refer MAX17701 IC data sheet.

Features

- Operates from a 9V to 60V Input Supply
- 20A CC Mode Charging Current
- 5V CV Mode Output Voltage
- 350kHz Switching Frequency
- Resistor-Programmable UVLO Threshold
- Input Short Protection
- CC Mode Safety Timer (TMR)
- Cycle-by-Cycle Overcurrent Limit
- External Clock Synchronization (RT/SYNC)
- Charger Status Flags (FLG1, FLG2)
- Charging Current Monitoring (ISMON)
- Output Overvoltage Protection (OVI)
- IC Overtemperature Protection
- Proven PCB Layout
- Fully Assembled and Tested

Ordering Information appears at end of data sheet.

Quick Start

Recommended Equipment

- MAX17701EVKITA#
- 60V, 20A DC input power supply
- 10A electronic load
- Four digital voltmeters (DVM)
- Digital ammeter (DAM)

Equipment Setup and Test Procedure

The EV kit is fully assembled and tested. Use the following steps to verify board operation:

Caution: Do not turn on power supply until all connections are completed.

- 1) Set electronic load with 10A and disable the electronic load.
- 2) Connect the positive terminal of the electronic load to the VOUT connector and negative terminal of electronic load to the nearest PGND connector.
- 3) Turn on electronic load and discharge supercapacitors till the voltage across the output goes to 0V. Disconnect the electronic load.
- 4) Set the power supply at a voltage between 9V and 60V. Disable the power supply.
- 5) Verify that shunts are installed across pins 1-2 on EN/UVLO jumper (J1), pins 1-2 on ILIM jumper (J2), pins 2-3 on TMR jumper (J3). See [Table 1](#), [Table 2](#), and [Table 3](#) for details.
- 6) Connect the positive terminal of the input power supply to the DCIN connector and the negative terminal to the nearest PGND connector.
- 7) Connect the positive terminal of the electronic load to the VOUT connector in series with DAM and the negative terminal to the nearest PGND connector.
- 8) Connect first DVM (DVM1) between the VOUT connector and nearest PGND connector. Connect second DVM (DVM2) between the ISMON PCB pad and nearest SGND PCB pad.
- 9) Connect third DVM (DVM3) between the FLG1 PCB pad and nearest SGND PCB pad. Connect fourth DVM (DVM4) between the FLG2 PCB pad and nearest SGND PCB pad.

MAX17701EVKITA# Evaluation Kit

Evaluates: MAX17701 in 5V Output-Voltage Application

- 10) Turn on DC power supply.
- 11) The charger starts in CC mode. Observe that the DVM2 displays 1.5V, translates to 20A charging current.
- 12) Verify that the FLG1 voltage displays 0V on DVM3 and FLG2 voltage displays 5V on DVM4, in CC mode.
- 13) The charger enters CV mode when V_{FB} reaches CV threshold (1.219V) and the charging current starts to fall from 20A. Observe that the voltage reading in DVM2 falls from 1.5V to 0.75V in CV mode.
- 14) Verify that both DVM3 and DVM4 displays 0V, in CV mode.
- 15) Verify that the current reading in DAM is 10A in both CC and CV modes.
- 16) The charger continues to regulate the output voltage in CV mode and supercapacitors are fully charged. Verify that the DVM1 displays close to 5V.
- 17) During charging process, verify that the FLG1 voltage displays 0V on DVM3, which shows that there is no fault.
- 18) After testing is completed, switch off the power supply. Remove the electronic load after supercapacitor voltage is discharged to 0V.

Detailed Description

The MAX17701EVKITA# (EV kit) provides charging solution for supercapacitor with CC mode charging current of 20A and CV mode voltage of 5V from a 9V to 60V input supply. The EV kit supports a continuous load current up to 10A at the output. The EV kit features a 350kHz switching frequency for optimum efficiency and component size. The RT/SYNC PCB pad allows an external clock to synchronize the device. The EV kit includes jumper J1 to enable/disable the controller. The FLG1 and FLG2 PCB pads allows to monitor the charger status. The ISMON PCB pad allows to monitor charging current.

Enable/Undervoltage-Lockout (EN/UVLO) Programming

The EV kit offers an adjustable input undervoltage lockout feature. The EN/UVLO pin can be used to set a desired input voltage at which the charger is enabled or disable the charger by pulling down EN/UVLO to SGND/EP. [Figure 1](#) shows the input under voltage lockout setting on the EV kit. The EN/UVLO pin can be used as input undervoltage lockout detector with a typical hysteresis of 160mV. To disable the MAX17701, install a shunt across pins 2–3 on J1. See [Table 1](#) for J1 settings. As shown in

[Figure 1](#), the input at which the charger controller of the IC turns on, can be set with a resistor-divider connected to EN/UVLO from DCIN to PGND. The $V_{DCIN(MIN)}$ is selected as 8.7V for this EV kit.

Choose R1 as follows:

$$R1 \leq (10000 \times V_{DCIN(MIN)})$$

where $V_{DCIN(MIN)}$ is the voltage at which the device is required to turn on.

Calculate the value of R2 using the following equation:

$$R2 = \frac{V_{EN_TH_R} \times R1}{V_{DCIN(MIN)} - V_{EN_TH_R} + (I_{EN-BIAS} \times R1)}$$

where:

$I_{EN-BIAS}$ = Internal bias pullup current on the EN/ULVO pin (3 μ A)

$V_{EN_TH_R}$ = EN/UVLO pin rising threshold voltage (1.25V)

For more details about setting the undervoltage lockout level, refer to the MAX17701 data sheet.

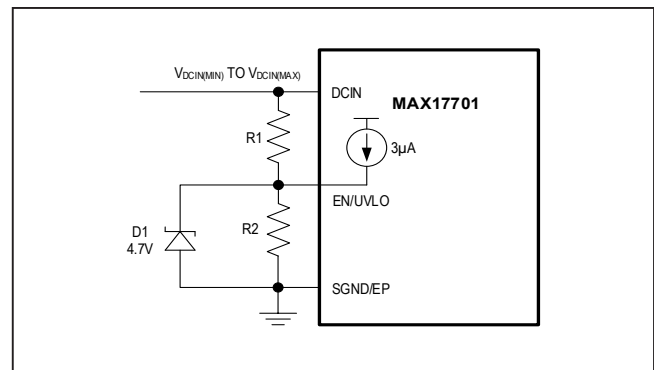

Figure 1. Setting the Input Under Voltage Lockout

Table 1. EN/UVLO Jumper (J1) Settings

JUMPER	SHUNT POSITION	EN/UVLO PIN	MAX17701 OUTPUT
J1	1-2*	Connected to the input UVLO divider midpoint	Enabled, UVLO level is set by the resistor divider from DCIN to SGND/EP
	2-3	Connected to SGND/EP	Disabled

*Default position

CC Mode Charging Current Setting (ILIM)

The EV kit provides the CC mode charge current programming feature. The ILIM PCB pad on the EV kit supports external control of the CC mode charging current (I_{CHGMAX}). See [Table 2](#) for J2 settings. To program the I_{CHGMAX} at 20A, install a jumper across pins 1–2 on J2. In order to control I_{CHGMAX} with an external dynamic input, install a jumper across pins 2-3 on J2 and apply a voltage (V_{ILIM}) between ILIM PCB pad and nearest SGND PCB pad. To program the I_{CHGMAX} at 10A, remove the jumper on J2. The allowable voltage range on V_{ILIM} is 0.15V–1.5V. For more details about the *CC Mode Charging Current Setting*, refer to the MAX17701 IC data sheet.

External Clock Synchronization (RT/SYNC)

The EV kit provides a RT/SYNC PCB pad to synchronize the MAX17701 to an optional external clock. The external synchronization clock frequency must be between 0.9 x f_{SW} and 1.1 x f_{SW}, where f_{SW} is the frequency of operation set by R10. In the presence of a valid external clock for synchronization for 112 cycles of internal switching clock, the MAX17701 starts to sync in with external clock. For more details about external clock synchronization, refer to the MAX17701 IC data sheet.

Charger Timers (TMR)

The EV kit features safety timer to set the timeout in CC mode. The safety timer is adjusted by the value of capacitor between TMR and SGND/EP. The default programmed safety timeout on the EV kit is 118sec. If the charger doesn't enter CV mode within 118 seconds, then the charger enters blanking fault. The charger stays idle for fault blanking time of 472sec before restarting the charging.

Table 2. ILIM Jumper (J2) Settings

JUMPER	SHUNT POSITION	ILIM PIN	I _{CHGMAX}
J2	1-2*	Connected to V _{REF}	20A
	2-3	Connected to ILIM PCB pad	13.33 x V _{ILIM}
	Not installed	Connected to ILIM resistor divider (R8 and R9) mid-point	10A

*Default position

The TMR jumper (J3) supports safety timer enable/disable feature. See [Table 3](#) for J3 settings. In order to disable the safety timer, install a jumper across pins 1–2 on J3. To enable the safety timer setting for 118sec, install a jumper across pins 2–3 on J3. For more details about charger timers, refer to the MAX17701 IC data sheet.

Charger Status Flags (FLG1, FLG2)

The EV kit provides FLG1 and FLG2 PCB pads to indicate the charger status. See [Table 4](#) for charger status flag summary.

For more details about safety timer fault or hardware faults, refer to the MAX17701 IC data sheet.

Hot Plug-In and Long Input Cables

The MAX17701EVKITA# PCB layout provides an electrolytic capacitor (C15 = 68µF/100V). This capacitor limits the peak voltage at the input of the MAX17701 when the DC input source is “hot-plugged” to the EV kit input terminals (DCIN) with long input cables. The equivalent series resistance (ESR) of the electrolytic capacitor dampens the oscillations caused by interaction of the inductance of the long input cables, and the ceramic capacitors at the buck converter input (VIN). An electrolytic capacitor at DCIN prevents the DCIN voltage from being less than -0.3V during input short events by providing damping with ESR.

Table 3. TMR Jumper (J3) Settings

JUMPER	SHUNT POSITION	TMR PIN	SAFETY TIMER SETTING
J3	1-2	Connected to V _{REF}	Disabled
	2-3*	Connected to TMR capacitor (33nF)	Enabled and set at 118 sec

*Default position

Table 4. Charger Status Flags Indications

CHARGER STATUS	V _{FLG2} (V)	V _{FLG1} (V)
Charger Off	5	5
CC Mode	5	0
CV Mode	0	0
Hardware Fault or Safety Timer Timeout	0	5

MAX17701EVKITA# Performance Report

(V_{DCIN} = 24V, V_{OUT} = 5V, I_{CHGMAX} = 20A, I_{LOAD} = 10A, f_{sw} = 350kHz, T_A = +25°C, unless otherwise noted.)

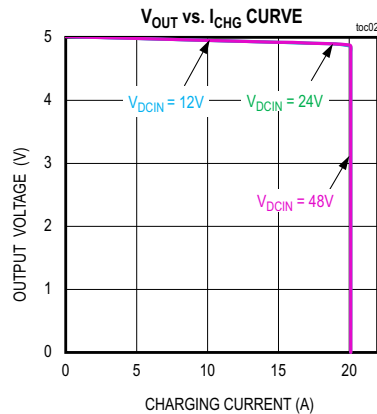
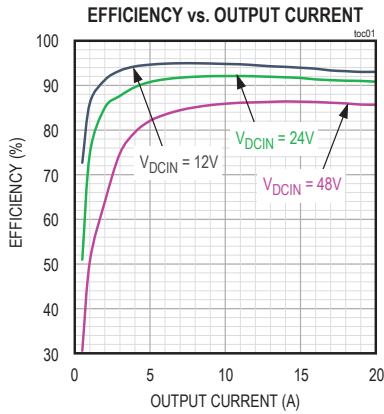

SUPERCAPACITOR CHARGING AT NO LOAD

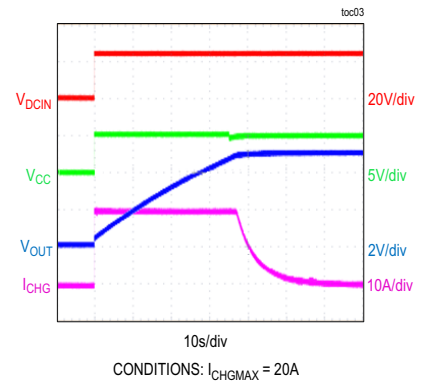

SUPERCAPACITOR CHARGING AT 10A LOAD

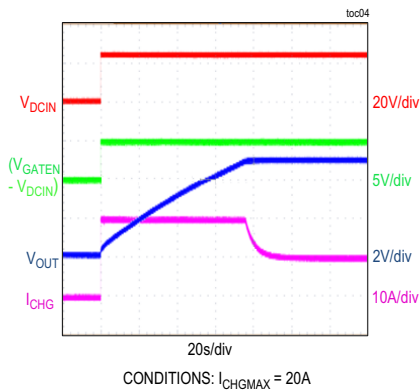

SUPERCAPACITOR CHARGING WITH PRE-BIASED OUTPUT OF 2.5V

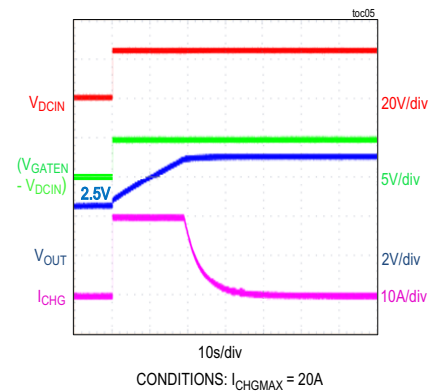

DCIN STARTUP

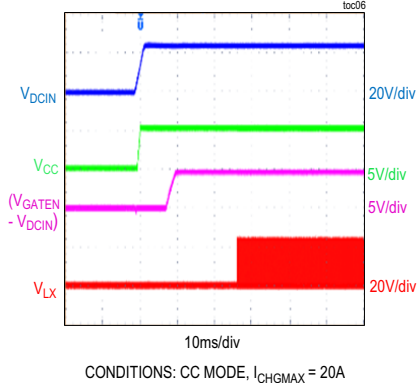

SHUTDOWN THROUGH EN/UVLO

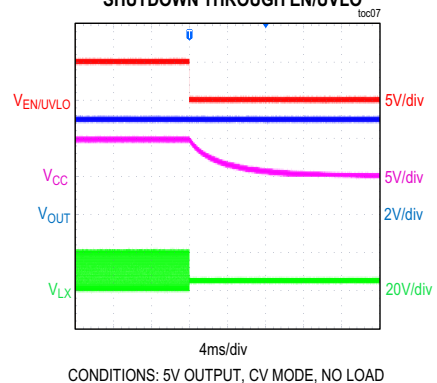

MAX17701EVKITA# Performance Report (continued)

(V_{DCIN} = 24V, V_{OUT} = 5V, I_{CHGMAX} = 20A, I_{LOAD} = 10A, f_{sw} = 350kHz, T_A = +25°C, unless otherwise noted.)

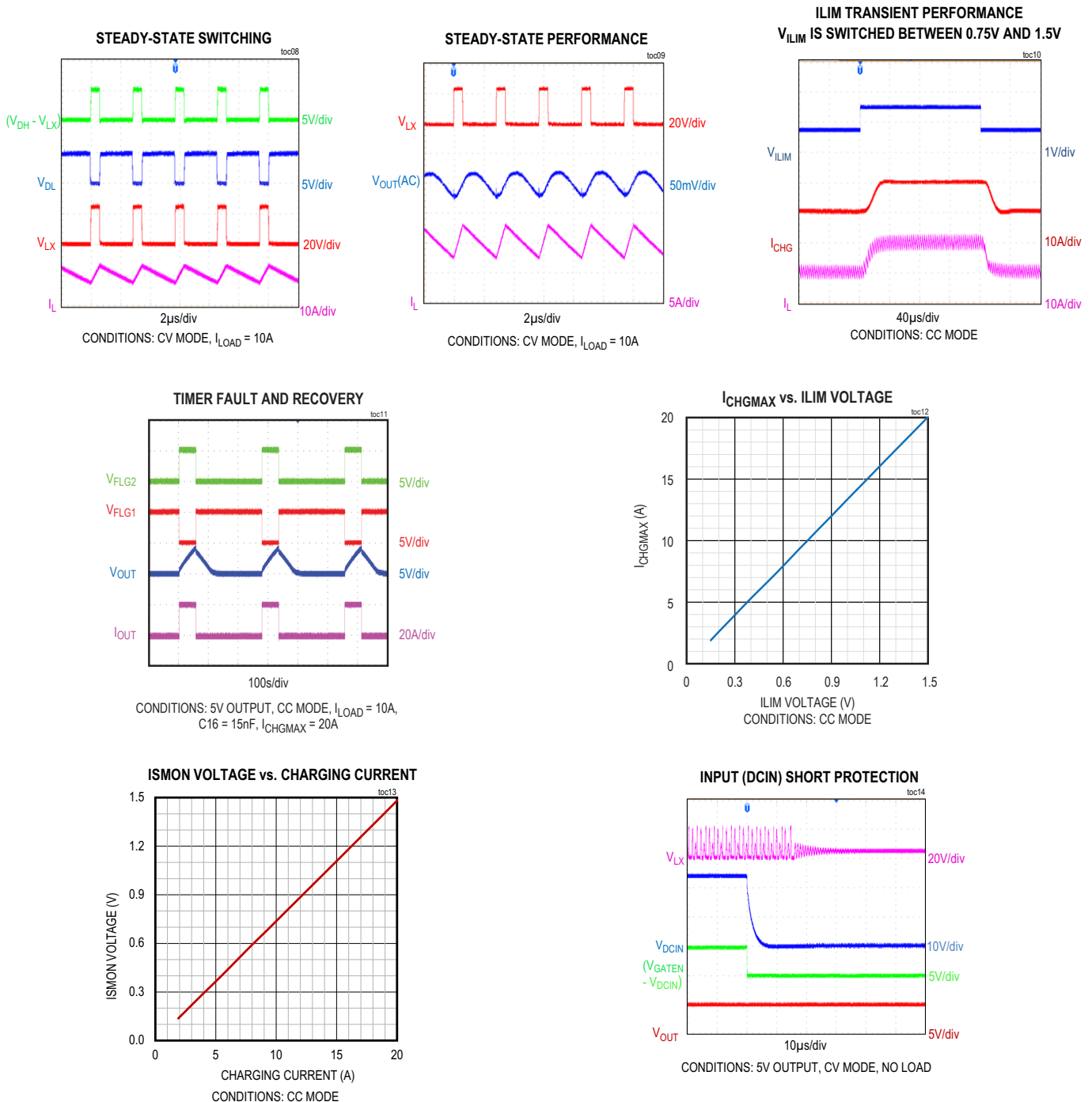

Component Suppliers

SUPPLIER	WEBSITE
Coilcraft, Inc.	www.coilcraft.com
Murata Americas	www.murataamericas.com
Tacate Group	www.tecategroup.com
Panasonic Corp.	www.panasonic.com
TDK	www.tdk.com
Vishay	www.vishay.com
Taiyo Yuden	www.t-yuden.com
Diodes Inc.	www.diodes.com
Yageo Corp.	www.yageo.com
KEMET Corporation	www.kemet.com
SullinsCorp	www.sullinscorp.com
Samsung	www.samsungsem.com
Comchip Technology Corporation	www.comchiptech.com
Keystone	www.keyelco.com

Note: Indicate that you are using the MAX17701 when contacting these component suppliers.

Ordering Information

PART	TYPE
MAX17701EVKITA#	EV Kit

#Denotes RoHS compliance.

MAX17701EVKITA# Bill of Materials

SL. No.	DESIGNATOR	DESCRIPTION	QTY	MANUFACTURER PART NUMBER
1	C1, C9, C10, C19, C20, C22, C25	4.7 μ F, 10%, 100V, X7R, Ceramic capacitor (1206)	7	MURATA GRM31CZ72A475KE11
2	C2, C11, C27, C42, C43	0.1 μ F, 10%, 100V, X7R, Ceramic capacitor (0603)	5	TAIYO YUDEN HMK107B7104KA
3	C3, C13, C28, C40, C53, C54	150pF, 5%, 100V, COG, Ceramic capacitor (0402)	6	TDK C1005C0G2A151J050BA
4	C12, C31, C39	0.1 μ F, 10%, 16V, X7R, Ceramic capacitor (0402)	3	TAIYO YUDEN EMK105B7104KV
5	C14	10pF, 5%, 50V, COG, Ceramic capacitor (0402)	1	KEMET C0402C100J5GACTU
6	C15	ALUMINUM-ELECTROLYTIC; 68UF; 100V; TOL=20%; MODEL=EEV SERIES	1	PANASONIC EEV-FK2A680Q
7	C16	0.033 μ F, 10%, 50V, X7R, Ceramic capacitor (0603)	1	SAMSUNG CL10B333KB8NNNC
8	C17, C41	6800pF, 10%, 25V, X7R, Ceramic capacitor (0402)	2	YAGEO CC0402KRX7R8BB682
9	C18	68pF, 5%, 50V, COG, Ceramic capacitor (0402)	1	KEMET C0402C680J5GAC
10	C21	4.7 μ F, 10%, 16V, X7R, Ceramic capacitor (0805)	1	MURATA GRM21BR71C475KE51
11	C23	1 μ F, 10%, 25V, X7R, Ceramic capacitor (0603)	1	TAIYO YUDEN TMK107B7105KA
12	C24	1000pF, 10%, 16V, X7R, Ceramic Capacitor (0402)	1	SAMSUNG CL05B102K05NNN
13	C26	0.47 μ F, 10%, 16V, X7R, Ceramic capacitor (0603)	1	MURATA GRM188R71C474K
14	C29	2200pF, 5%, 50V, X7R, Ceramic capacitor (0402)	1	MURATA GRM155R71H222JA01
15	C34	220 μ F, TOL=20%, 6.3V, TANTALUM CHIP	1	PANASONIC 6TCE220MI
16	C36, C37	47 μ F, 10%, 10V, X7R, Ceramic capacitor (1210)	2	MURATA GRM32ER71A476KE15
17	C47	2200pF, 10%, 50V, X7R, Ceramic capacitor (0402)	1	TDK CGA2B2X7R1H222K050BA
18	D1	ZENER DIODE VZ=4.7V; IZ=0.005A	1	COMCHIP CZRU52C4V7
19	D2	SCHOTTKY DIODE PIV=100V; IF=1A	1	DIODES INCORPORATED DFLS1100-7
20	L1	INDUCTOR, 2.2 μ H, 32A (10mm x 10mm), 2.8m Ω	1	COILCRAFT XAL1010-222ME
21	Q1	N-CHANNEL POWER MOSFET(PowerPAK® SO-8) PD-(6.25W); I-(95A); V-(100V)	1	VISHAY SIR170DP-T1-RE3
22	Q2, Q3, Q5, Q6	N-CHANNEL POWER MOSFET (PowerPAK® SO-8) PD-(6.25W); I-(60A); V-(80V)	4	VISHAY SIR826ADP-T1-GE3
23	R1	RESISTOR, 86.6K Ω , 1% (0603), 0.1W	1	VISHAY DALE CRCW060386K6FK
24	R2	RESISTOR, 14K Ω , 1% (0603), 0.1W	1	PANASONIC ERJ-3EKF1402
25	R3	RESISTOR, 93.1K Ω , 1% (0402), 0.0625W	1	VISHAY DALE CRCW040293K1FK
26	R4	RESISTOR, 28.7K Ω , 1% (0402), 0.0625W	1	VISHAY DALE CRCW040228K7FK
27	R5, R6	RESISTOR, 330 Ω , 1% (0603), 0.1W	2	VISHAY DALE CRCW0603330RFK
28	R7, R14	RESISTOR, 10K Ω , 1% (0402), 0.1W	2	VISHAY DALE CRCW040210K0FK
29	R8	RESISTOR, 105K Ω , 1% (0402), 0.0625W	1	VISHAY DALE CRCW0402105KFK
30	R9	RESISTOR, 45.3K Ω , 1% (0402), 0.0625W	1	VISHAY DALE CRCW040245K3FK

MAX17701EVKITA# Bill of Materials (continued)

SL. No.	DESIGNATOR	DESCRIPTION	QTY	MANUFACTURER PART NUMBER
31	R11, R15, R28	RESISTOR, 0Ω, 5% (0402), 0.0625W	3	YAGEO PHYCOMP RC0402JR-070RL
32	R12	RESISTOR, 15.4KΩ, 1% (0402), 0.1W	1	PANASONIC ERJ-2RK1542
33	R17-R20	RESISTOR, 1Ω, 1% (0402), 0.0625W	4	VISHAY DALE CRCW04021R00FK
34	R26	RESISTOR, 40.2Ω, 1% (0402), 0.0625W	1	VISHAY DALE CRCW040240R2FK
35	R27	RESISTOR, 0.0025Ω, 1% (2512), 2W	1	VISHAY WSL25122L500FEA18
36	R30	RESISTOR, 52.3KΩ, 1% (0402), 0.0625W	1	VISHAY DALE CRCW040252K3FK
37	R31	RESISTOR, 17.4KΩ, 1% (0402), 0.0625W	1	YAGEO PHYCOMP RC0402FR-0717K4L
38	SUP1, SUP2	SUPERCAPACITOR, 350F, 3V, 4mΩ	2	TECATE GROUP TPLH-3R0/350SS35X61
39	U1	SYNCHRONOUS STEP-DOWN SUPERCAPACITOR CHARGER CONTROLLER(TQFN24-EP 4mm x 4mm)	1	MAX17701ATG+
40	DCIN, PGND, PGND2, VOUT	BANANA JACK (5.2mm DIA X 5.5mm LENGTH)	4	KEY STONE 575-4
41	ILIM_EXT	TEST POINT, PIN DIA=0.1IN; TOTAL LENGTH=0.3IN;	1	KEY STONE 5000
42	J1-J3	3-pin header (0.1" centers)	3	SULLINS PEC03SAAN
43	—	SHUNTS	3	SULLINS STC02SYAN
44	C4-C8, C32, C33, C45, C48-C52	OPEN: CAPACITOR (1206)	0	
45	C30, C46	OPEN: CAPACITOR (0402)	0	
46	C35	OPEN: TANTALUM CAPACITOR (2917)	0	
47	C38, C44	OPEN: CAPACITOR (1210)	0	
48	L2	OPEN: INDUCTOR (10mmx10mm)	0	
49	D3	OPEN: SCHOTTKY DIODE (SMB)	0	
50	R10, R29	OPEN: RESISTOR (0402)	0	

DEFAULT JUMPER TABLE	
JUMPER	SHUNT POSITION
J1, J2	1-2
J3	2-3

MAX17701EVKITA# Schematic

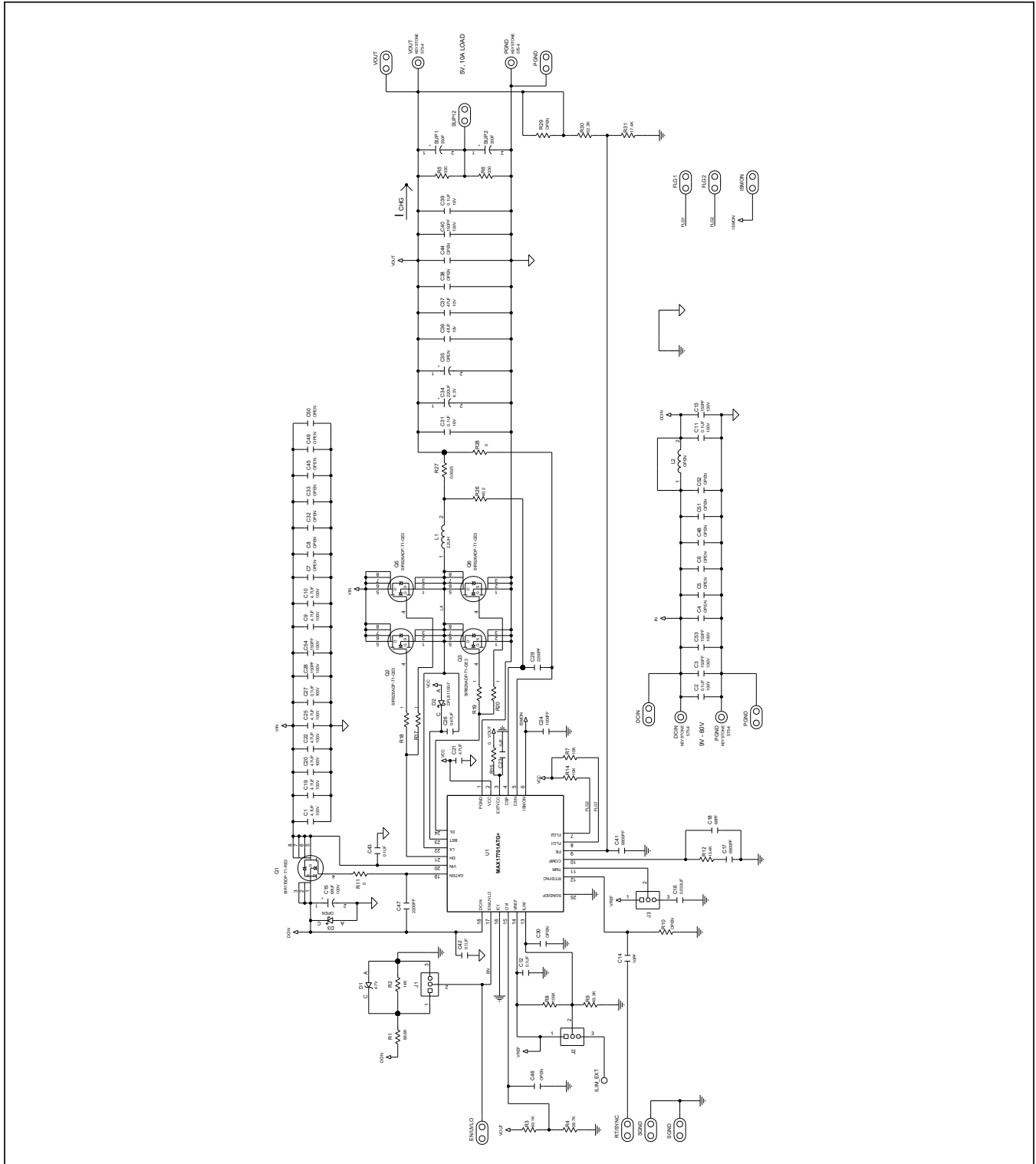

MAX17701EVKITA# PCB Layouts

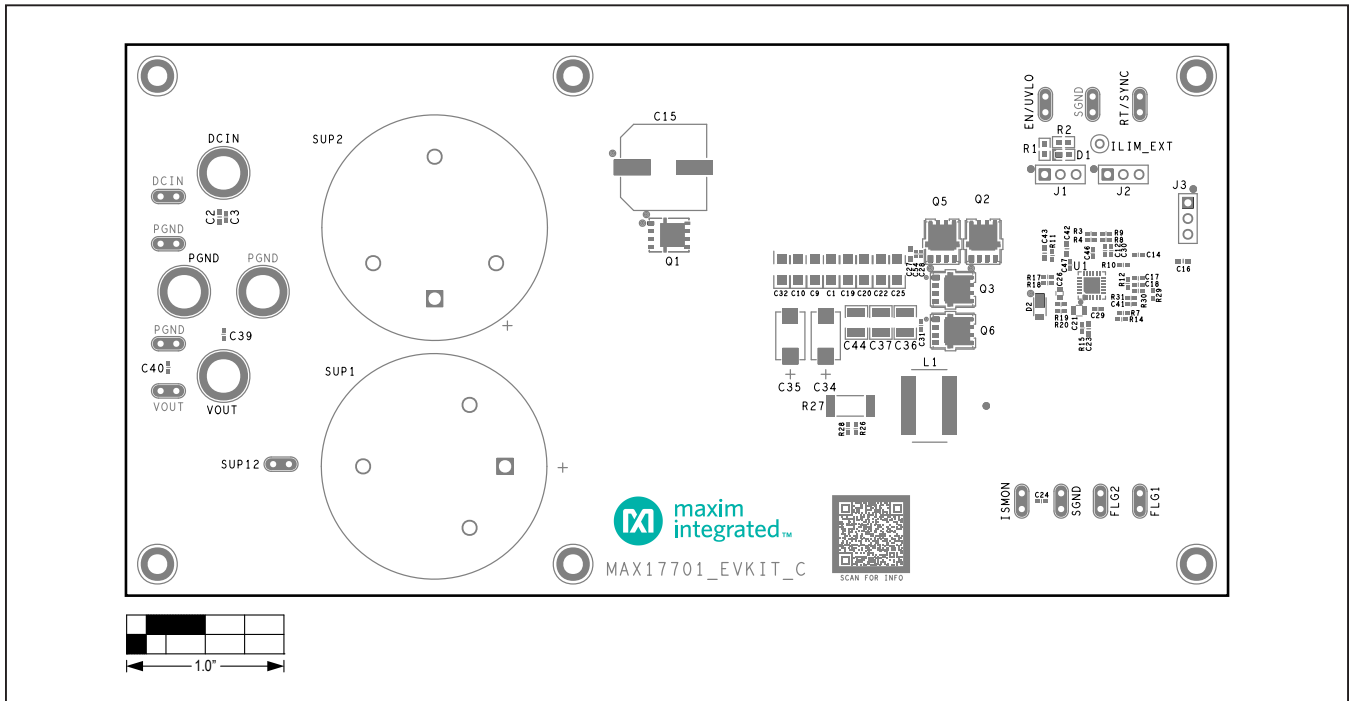

MAX17701EVKITA# EV Kit Component Placement Guide—Top Silkscreen

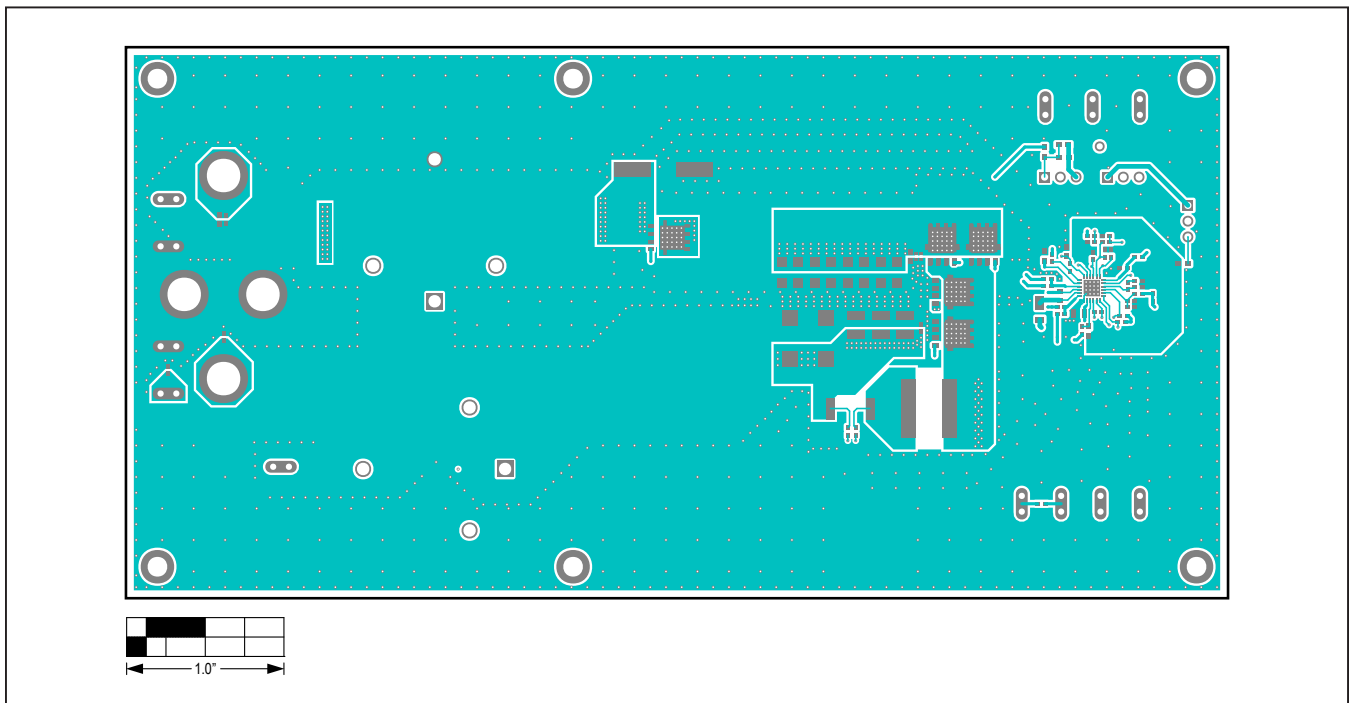

MAX17701EVKITA# EV Kit PCB Layout—Top Layer

MAX17701EVKITA# PCB Layouts (continued)

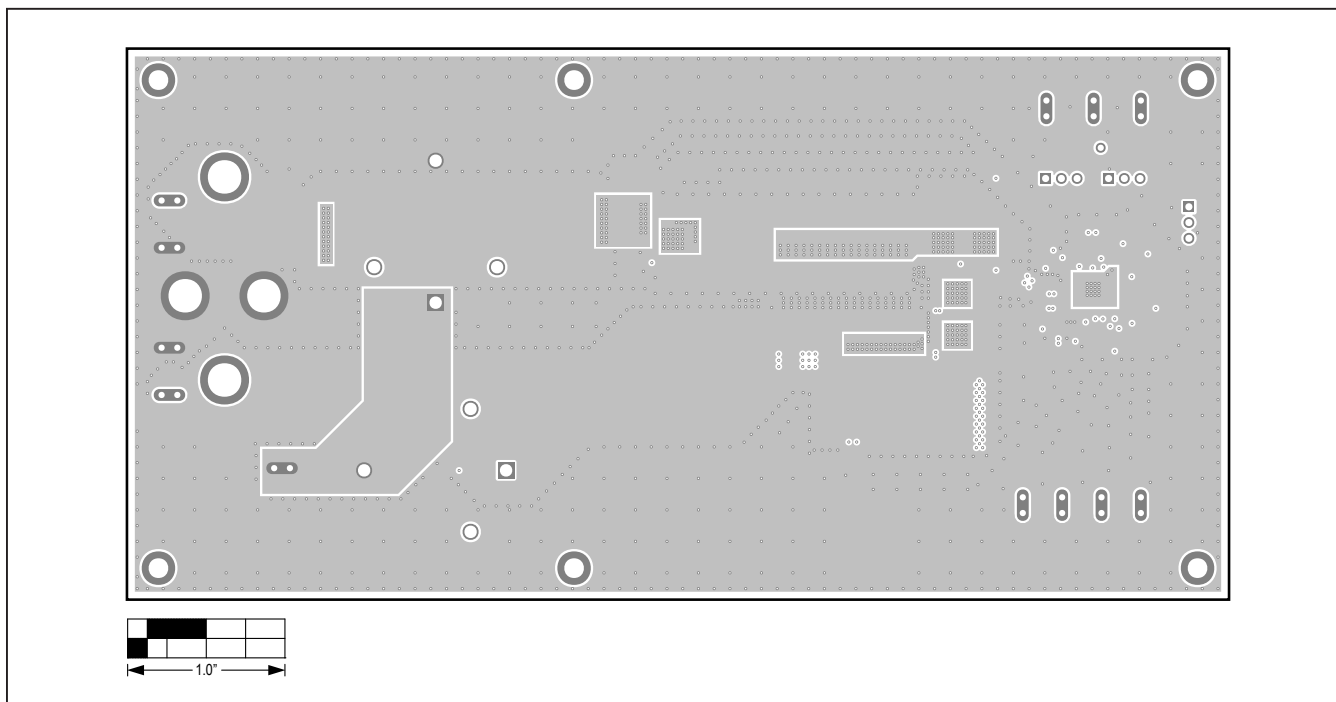

MAX17701EVKITA# EV Kit PCB Layout—Layer 2

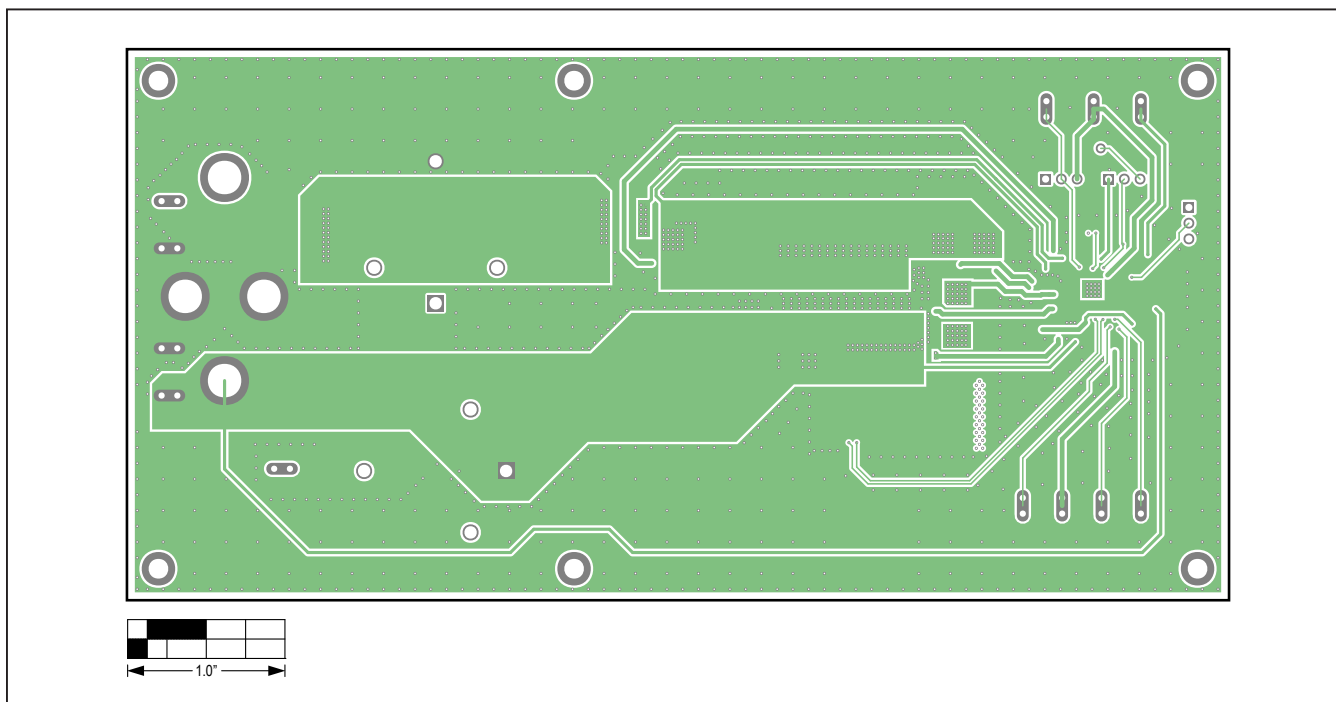

MAX17701EVKITA# EV Kit PCB Layout—Layer 3

MAX17701EVKITA# PCB Layouts (continued)

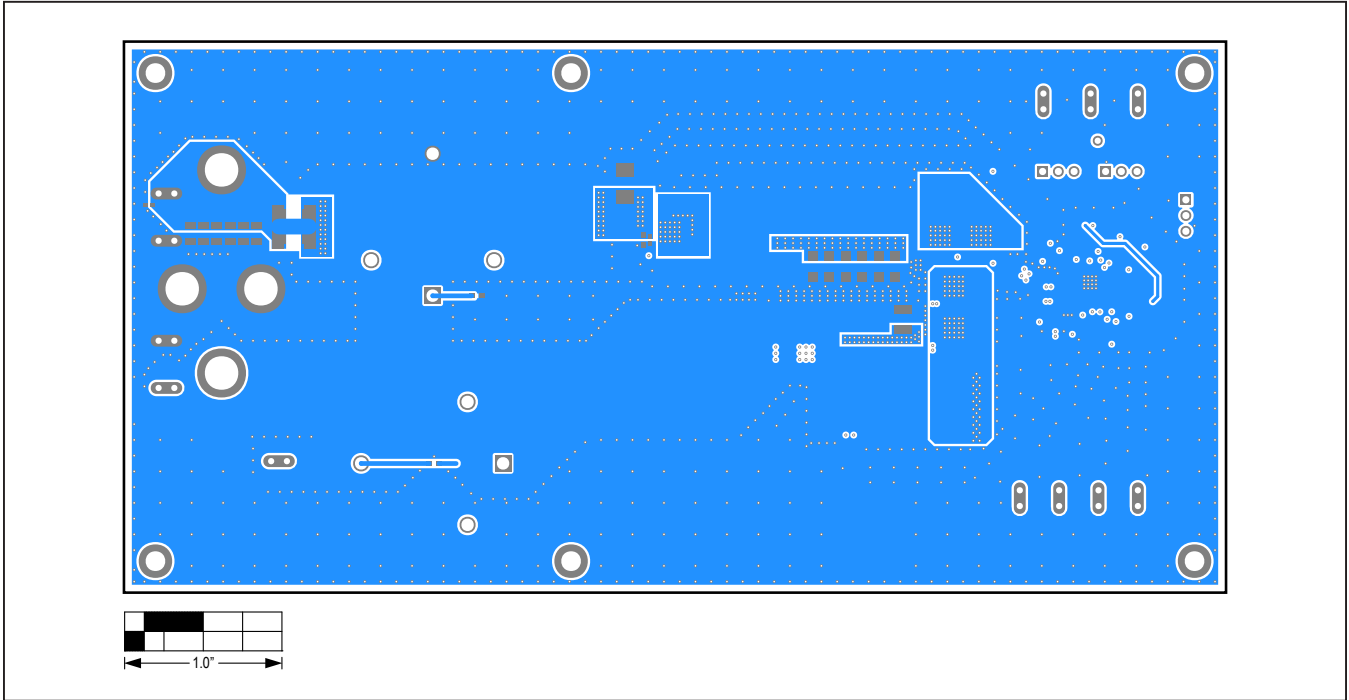

MAX17701EVKITA# EV Kit PCB Layout—Bottom Layer

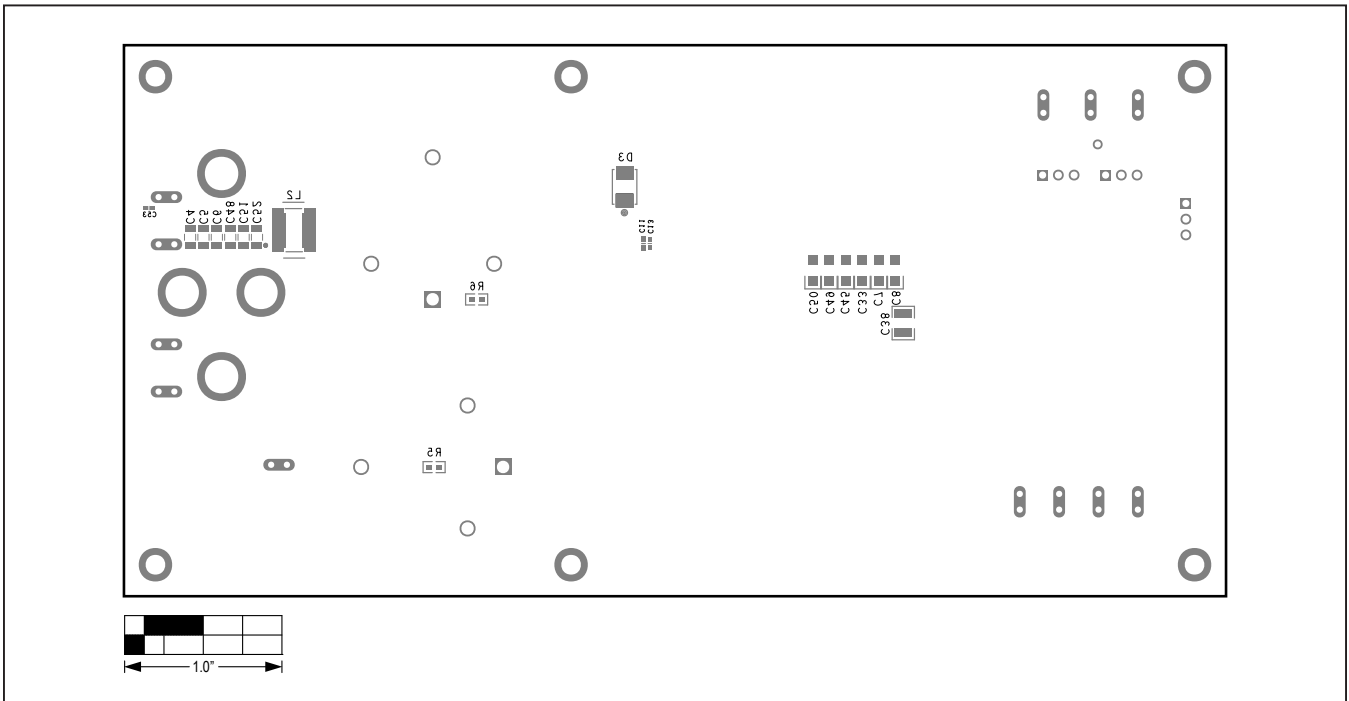

MAX17701EVKITA# EV Kit Component Placement Guide—Bottom Silkscreen

Revision History

REVISION NUMBER	REVISION DATE	DESCRIPTION	PAGES CHANGED
0	7/20	Initial release	—
1	12/20	Updated TOC01, and the <i>Bill of Materials</i> , <i>Schematics</i> , and <i>PCB Layout</i> sections	4–11
2	3/21	Updated <i>Features</i> , <i>Quick Start</i> , <i>Detailed Description</i> , <i>TOC 1</i> , <i>TOC 11</i> , <i>TOC 12</i> , <i>Component Suppliers</i> , <i>MAX17701EVKITA# Bill of Materials</i> , <i>MAX17701EVKITA# Schematic</i> and <i>MAX17701EVKITA# PCB Layouts</i> sections	1–12
3	4/21	Updated <i>MAX17701EVKITA# Schematic Diagram</i>	9

For pricing, delivery, and ordering information, please visit Maxim Integrated's online storefront at <https://www.maximintegrated.com/en/storefront/storefront.html>.

Maxim Integrated cannot assume responsibility for use of any circuitry other than circuitry entirely embodied in a Maxim Integrated product. No circuit patent licenses are implied. Maxim Integrated reserves the right to change the circuitry and specifications without notice at any time.