

MAX16840L Evaluation Kit

Evaluates: MAX16840

General Description

The MAX16840L low-power (5W input) evaluation kit (EV kit) demonstrates the MAX16840 HBLED driver IC used for Solid State Lighting (SSL) applications. The EV kit is configured as a buck-boost topology for 3 to 5 LEDs with an output power of 4W. The device is designed for standard MR16 applications. The typical input power from 12V AC is 5W.

The EV kit is a fully assembled and tested surface-mount PCB designed and optimized to accommodate an MR16 application form factor. The EV kit is compatible with electronic and magnetic transformers.

SSL MR16 lamps face compatibility issues with electronic transformers at low power levels. If the current drawn from an electronic transformer is below a certain level it stops operating, which could cause visible flicker from the lamp. Due to compatibility issues with electronic transformers at low power levels, active power-factor correction (PFC) is not featured in this EV kit.

To improve its compatibility with electronic transformers at low power levels, an input electrolytic capacitor is included on this EV kit. For this reason, it is not dimmable.

Features

- ◆ **Input Voltages Allowed**
 - 9V AC to 13.2V AC from AC Source or from Magnetic Transformers
 - 9V DC to 18V DC
 - Output of Several Electronic Transformers
- ◆ **Drives 3 to 5 Series HBLEDs**
- ◆ **46V Overvoltage Protection**
- ◆ **4W Output Power**
- ◆ **Proven PCB Layout**
- ◆ **Fully Assembled and Tested**

Ordering Information appears at end of data sheet.

Component List

DESIGNATION	QTY	DESCRIPTION
C1	1	330 μ F \pm 20%, 25V electrolytic capacitor Rubycon ZLH series
C2	1	0.22 μ F \pm 10%, 25V X7R ceramic capacitor (0603) Murata GRM188R71E224KA88D
C3, C4	2	10 μ F \pm 10%, 16V X7R ceramic capacitors (1206) Taiyo Yuden EMK316B7106KL-TD
C5	1	0.1 μ F \pm 10%, 50V X7R ceramic capacitor (0603) Murata GRM188R71H104K
C6	1	1nF \pm 5%, 50V C0G X7R ceramic capacitor (0603) Murata GRM1885C1H102JA01D
C7	1	100pF \pm 5%, 50V C0G ceramic capacitor (0603) Murata GRM1885C1H101J
D1	1	Schottky bridge-rectifier diode (HD DIP) Central Semi CBRHDSH1-40L

DESIGNATION	QTY	DESCRIPTION
D2	1	3A, 60V Schottky diode (SMA) Diodes Inc. B360A-13-F
F1	1	1.5A, 63V fuse Littelfuse 0466 1.5NR
L1	1	33 μ H, 1.15A inductor Würth 744778133
Q1	1	Dual npn transistor (SOT363) Central Semi CMKT5088 (Top Mark: K88)
R1	1	0.1 Ω \pm 1%, 1/2W resistor (1210)
R2	1	464k Ω resistor (0603)
R3, R4	2	12k Ω \pm 1% resistors (0603)
R5	1	9.1k Ω \pm 1% resistor (0603)
R6	1	26.1k Ω \pm 1% resistor (0603)
R7	1	0.27 Ω \pm 1%, 1/2W resistor (0603)
U1	1	LED driver with integrated switch (10 TDFN-EP) Maxim MAX16840ATB+ (Top Mark: AWY)
—	1	PCB: MAX16840 EVALUATION KIT#

MAX16840L Evaluation Kit

Evaluates: MAX16840

Component Suppliers

SUPPLIER	PHONE	WEBSITE
Central Semiconductor Corp.	631-435-1110	www.centralsemi.com
Diodes Incorporated	805-446-4800	www.diodes.com
Littelfuse, Inc.	773-628-1000	www.littelfuse.com
Murata Electronics North America, Inc.	770-436-1300	www.murata-northamerica.com
Rubycon Corp.	408-467-3864	www.rubycon.com
Taiyo Yuden	800-348-2496	www.t-yuden.com
Würth Elektronik GmbH & Co. KG	201-768-8800	www.we-online.com

Note: Indicate you are using the MAX16840L EV kit when contacting these component suppliers.

Quick Start

Required Equipment

- MAX16840L EV kit
- AC or DC source
- 3 to 5 series-connected LED strings rated no less than 330mA
- Current probe to measure the LED current (the HBLED should be illuminated)

Procedures

The EV kit is fully assembled and tested. Follow the steps below to verify board operation. **Caution: Do not turn on the power supply until all connections are completed.**

- 1) Connect the AC or DC source to the AC1 and AC2 PCB pads.
- 2) Connect the LED string anode and cathode to the LED+ and LED- PCB pads, respectively.
- 3) Clip the current probe across the LED+ wire to measure the HBLED current.
- 4) Enable the power supply.
- 5) Measure the LED current using the current probe.

Detailed Description of Hardware

The MAX16840L EV kit demonstrates the MAX16840 HBLED driver IC. The device is an average current-mode-control HBLED driver IC for step-down (buck), step-up (boost), and step-up/step-down (buck-boost) topologies in low-voltage SSL applications. The device has an integrated 0.2Ω (max), 48V switching MOSFET, which

allows the device to be used in lighting applications for MR16 and other SSL applications for power levels up to 10W. The IC uses a patent-pending input-current control scheme to achieve PFC. The HBLED driver uses a fixed-frequency average current-mode to control the duty cycle of the integrated switching MOSFET. The device is available in a 10-pin TDFN package with an exposed pad.

The EV kit circuit is configured in a buck-boost topology that operates at the device's fixed 300kHz switching frequency and provides up to 4W of output power for a string of 3 to 5 series HBLEDs connected at the LED+ and LED- PCB pads. The EV kit circuit operates from an AC or DC supply voltage of 9V_{RMS} to 13.2V_{RMS} and from electronic transformers. The EV kit is designed on a proven 2oz copper, two-layer small PCB footprint design that accommodates an MR16 application form factor.

The device uses average current-mode control, with the circuit configured such that the average current flowing into the current-sense resistor (R7) on a cycle-by-cycle (switching frequency) basis is set by the voltage on the REFI pin. The average current per switching cycle flowing into R7 is:

$$I_{AV} = \frac{V_{REF1}}{6.15 \times R3}$$

Circuit components R2, R3, R4, and Q1 are used to control the input current. The average voltage across the input capacitors (C1 and C2) is used to control the current in the current-mirror circuit formed by R2, R3, R4, and Q1. The current flowing into R2 is approximately proportional to the voltage on C1 and C2 and is now reflected on pin 3 of Q1, which sinks the same amount

MAX16840L Evaluation Kit

Evaluates: MAX16840

of current from pin 3 of Q1 as that which flows into R2. Inside the device is a 50 μ A current source. The current flowing into R6 sets the input current or the average current flowing into R7. The circuit tries to keep the input power over the line range of 9V AC to 13.2V AC almost constant, thus achieving LED current regulation in the $\pm 10\%$ range over the input range.

Figure 1 illustrates the current waveform in a 4 LED string when the EV kit is powered from a magnetic transformer with a 12V AC, 60Hz output.

In order to charge electrolytic capacitor C1 at the beginning of each power-line cycle, a peaky current is drawn from the electronic transformer. Notice that the electronic transformer is active (switching) until the peak current is 700mA. When the current goes below this level the electronic transformer stops switching.

Maximum LED+ Voltage

The device features an internal 46V overvoltage protection at the IN pin to protect the internal switching MOSFET from damage if the LED string is open or if the voltage on the LED string is too high. However, when operating the EV kit buck-boost circuit, the LED+ voltage should be limited to 40V.

Electronic and Magnetic Transformer Compatibility

The MR16 board was tested with 4 LEDs for electronic and magnetic transformer compatibility. Table 1 shows the results with the different transformer models tested.

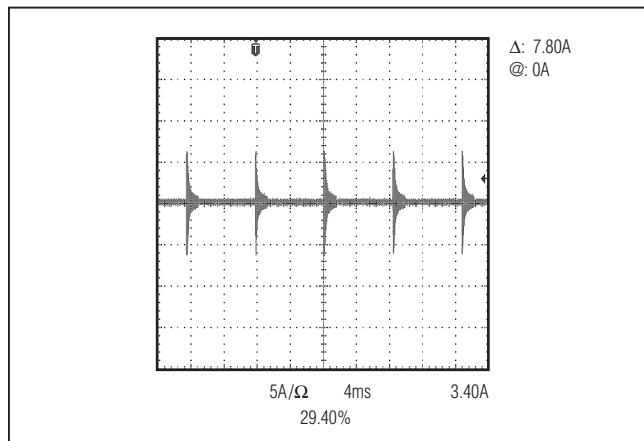

Figure 1. LED Current Waveform Using an Electronic Transformer (Lichtech LET60)

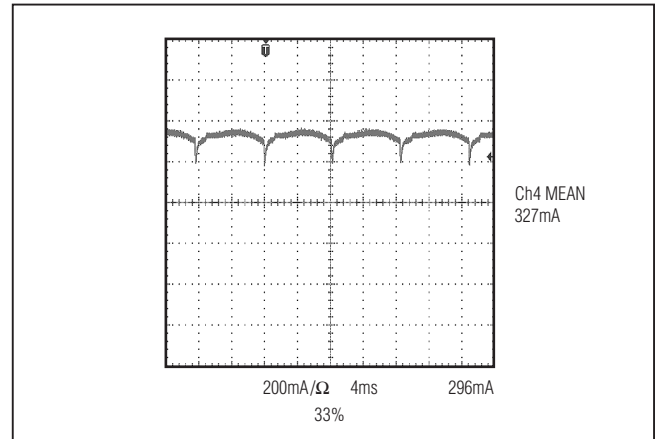

Figure 2. Input Current Waveform Using an Electronic Transformer (Lichtech LET60)

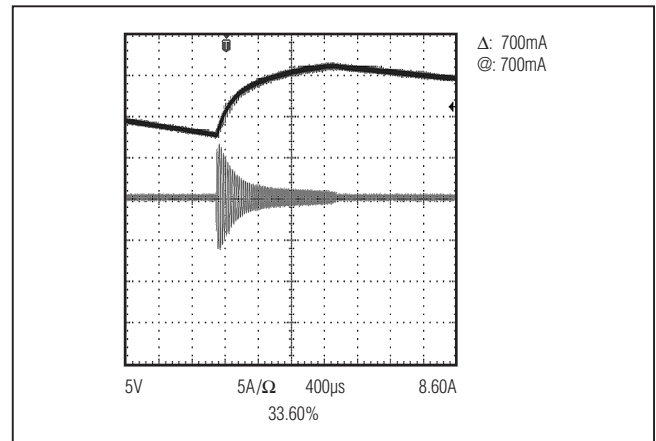

Figure 3. Performance with an Electronic Transformer (Lichtech LET60)
(CH1: Voltage waveform across input electrolytic capacitor C1;
CH4: Input current waveform)

MAX16840L Evaluation Kit

Evaluates: MAX16840

Table 1. Recommended Electronic and Magnetic Transformers

TRANSFORMER	TESTED INPUT VOLTAGE RANGE	PERFORMANCE WITHOUT DIMMER*
Lightech LVT60	108V AC to 132V AC/60Hz	108V AC, 320mA LED current 120V AC, 329mA LED current 132V AC, 332mA LED current
Lightech LET60		108V AC, 323mA LED current 120V AC, 330mA LED current 132V AC, 332mA LED current
Lightech LET75		108V AC, 318mA LED current 120V AC, 331mA LED current 132V AC, 333mA LED current
Lightech LET105		108V AC, 330mA LED current 120V AC, 333mA LED current 132V AC, 333mA LED current
Pony PET-120-12-75		108V AC, 324mA LED current 120V AC, 332mA LED current 132V AC, 333mA LED current
Pony PET-120-12-60		108V AC, 329mA LED current 120V AC, 331mA LED current 132V AC, 333mA LED current
CDN CS60	207V AC to 254V AC/50Hz	207V AC, 318mA LED current 230V AC, 329mA LED current 254V AC, 332mA LED current
GE SET60LS		207V AC, 307mA LED current 230V AC, 325mA LED current 254V AC, 327mA LED current
Nobile EN-60D		207V AC, 317mA LED current 230V AC, 328mA LED current 254V AC, 333mA LED current
Nobile EN-110D		207V AC, 318mA LED current 230V AC, 329mA LED current 254V AC, 332mA LED current
Nobile EN-150D		207V AC, 327mA LED current 230V AC, 335mA LED current 254V AC, 333mA LED current
Nobile EN-250D		207V AC, 316mA LED current 230V AC, 327mA LED current 254V AC, 328mA LED current
NVC ET-60E		207V AC, 322mA LED current 230V AC, 333mA LED current 254V AC, 335mA LED current
NVC ET-50S		207V AC, 319mA LED current 230V AC, 326mA LED current 254V AC, 331mA LED current
Oppla DB602		207V AC, 319mA LED current 230V AC, 329mA LED current 254V AC, 333mA LED current

MAX16840L Evaluation Kit

Evaluates: MAX16840

Table 1. Recommended Electronic and Magnetic Transformers (continued)

TRANSFORMER	TESTED INPUT VOLTAGE RANGE	PERFORMANCE WITHOUT DIMMER*
Osram HTM75	207V AC to 254V AC/50Hz	207V AC, 320mA LED current 230V AC, 333mA LED current 254V AC, 334mA LED current
Osram HTM70		207V AC, 315mA LED current 230V AC, 329mA LED current 254V AC, 332mA LED current
Osram HTM105		207V AC, 310mA LED current 230V AC, 328mA LED current 254V AC, 333mA LED current
Osram HTM150		207V AC, 288mA LED current 230V AC, 320mA LED current 254V AC, 330mA LED current
Osram ECO-ET105		207V AC, 304mA LED current 230V AC, 327mA LED current 254V AC, 330mA LED current
Osram ET-PARROT 105		207V AC, 308mA LED current 230V AC, 331mA LED current 254V AC, 332mA LED current
Osram ET-P 60		207V AC, 308mA LED current 230V AC, 332mA LED current 254V AC, 330mA LED current
Philips Certaline 60W		207V AC, 315mA LED current 230V AC, 331mA LED current 254V AC, 332mA LED current
Philips Certaline 105W		207V AC, 298mA LED current 230V AC, 320mA LED current 254V AC, 328mA LED current
Philips Certaline 150W		207V AC, 284mA LED current 230V AC, 310mA LED current 254V AC, 328mA LED current
Philips ET-E 60		207V AC, 313mA LED current 230V AC, 330mA LED current 254V AC, 332mA LED current
Shreyesh 50WH (Made in India)		207V AC, 288mA LED current 230V AC, 314mA LED current 254V AC, 329mA LED current
TCL ET-60H		207V AC, 320mA LED current 230V AC, 331mA LED current 254V AC, 331mA LED current
Varilight YT70L		207V AC, 322mA LED current 230V AC, 328mA LED current 254V AC, 330mA LED current
Varilight YT150		207V AC, 324mA LED current 230V AC, 332mA LED current 254V AC, 334mA LED current

*No flicker.

MAX16840L Evaluation Kit

Evaluates: MAX16840

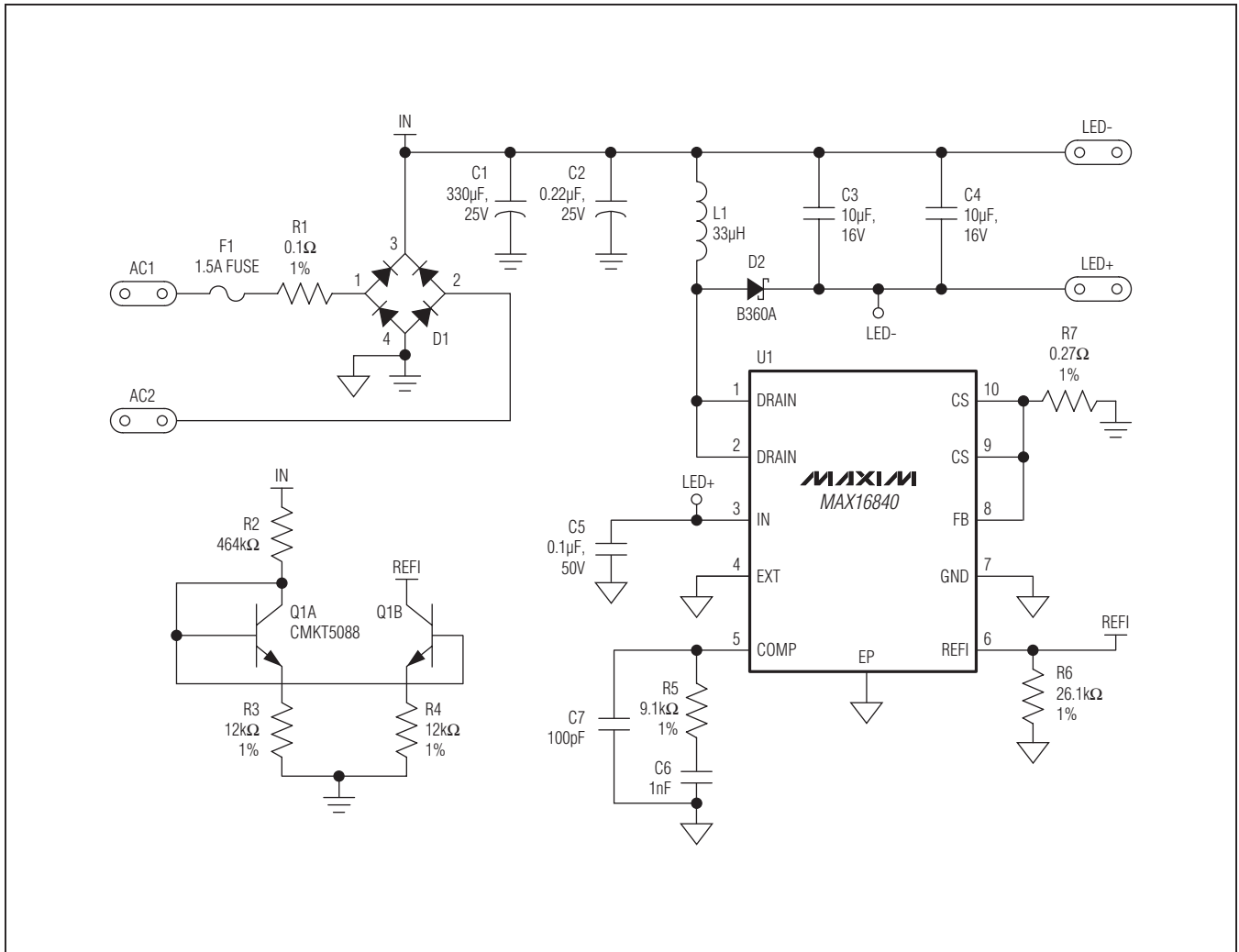

Figure 4. MAX16840L EV Kit Schematic

MAX16840L Evaluation Kit

Evaluates: MAX16840

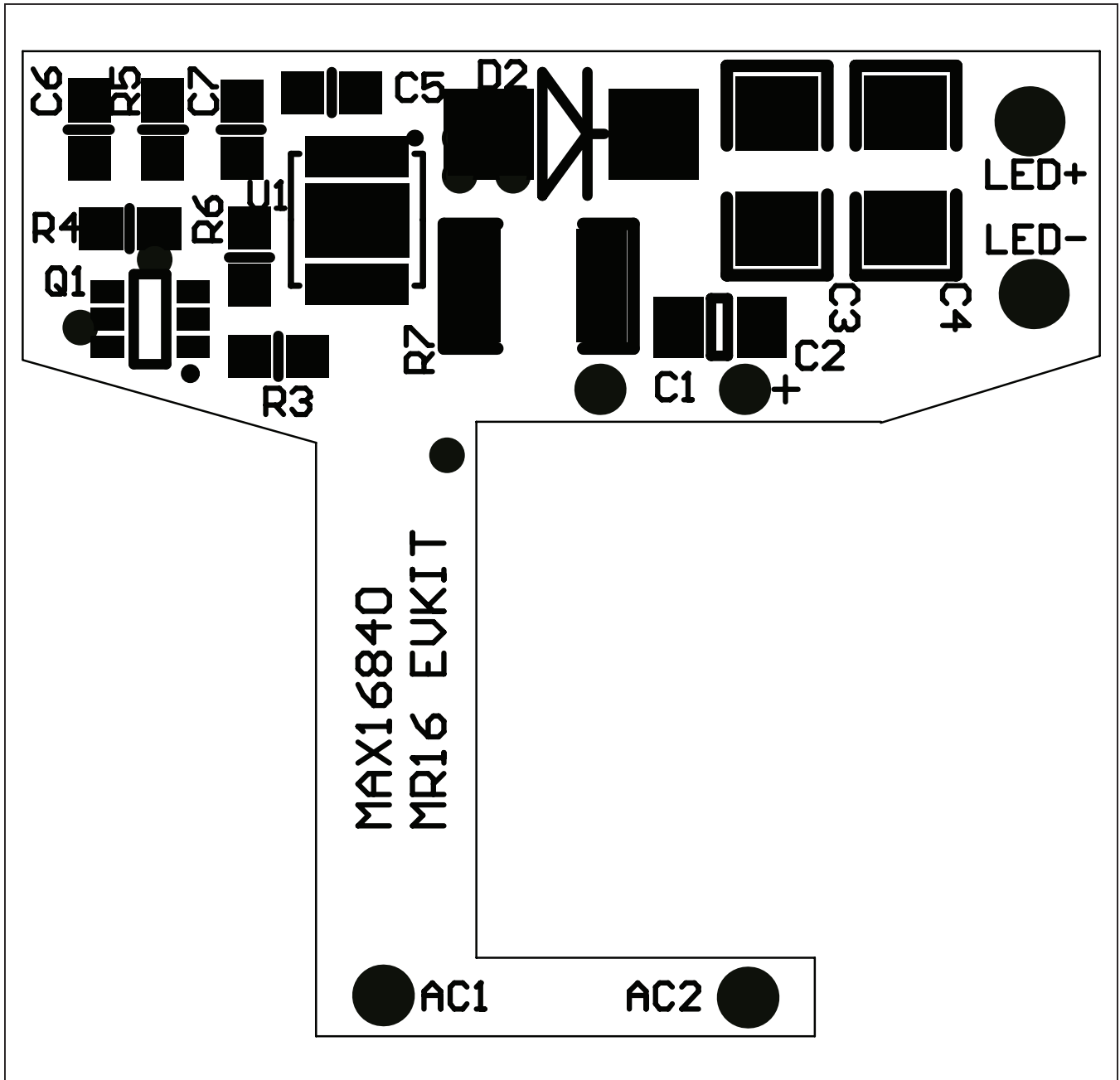

Figure 5. MAX16840L EV Kit Component Placement Guide—Component Side

MAX16840L Evaluation Kit

Evaluates: MAX16840

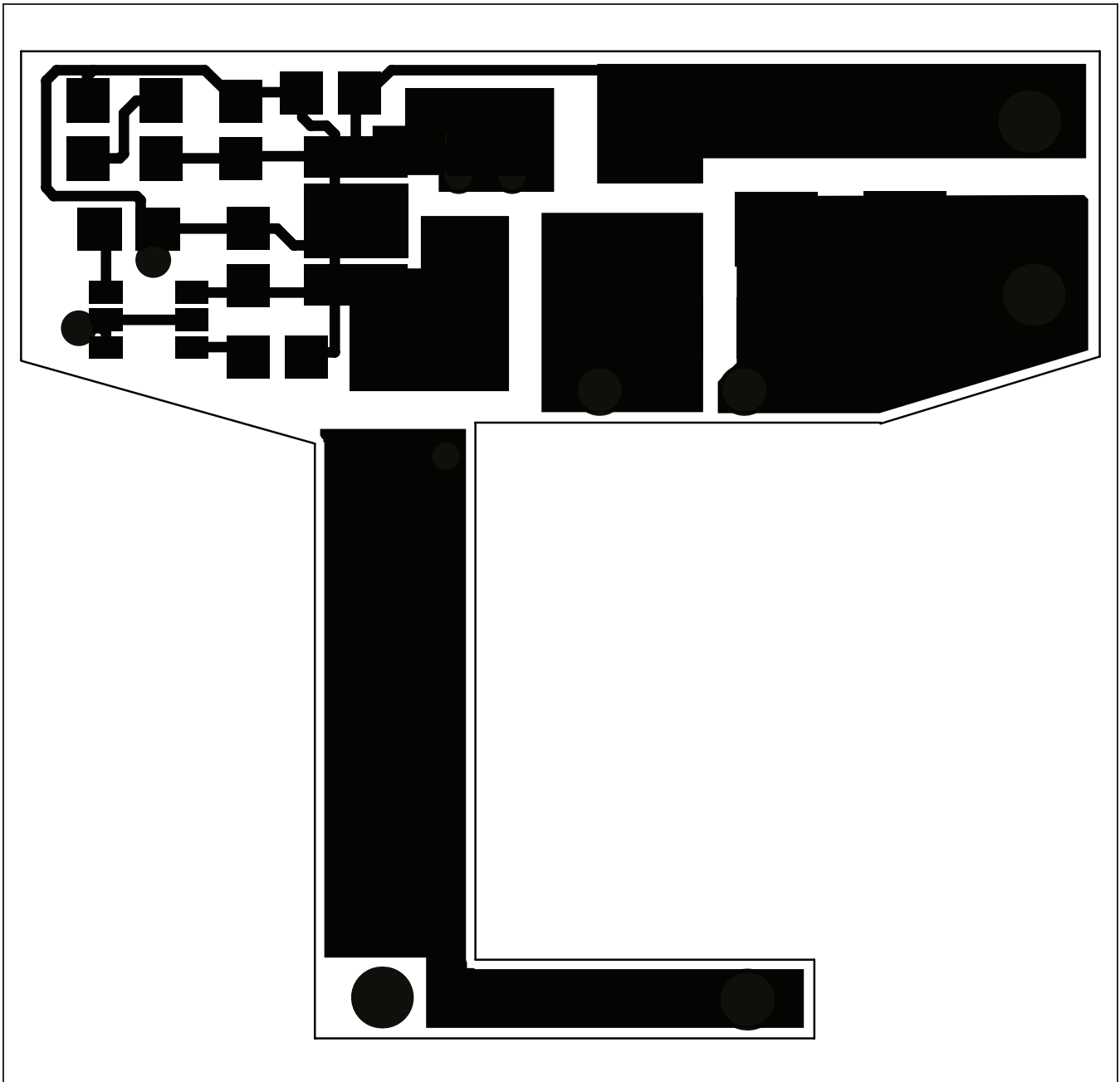

Figure 6. MAX16840L EV Kit PCB Layout—Component Side

MAX16840L Evaluation Kit

Evaluates: MAX16840

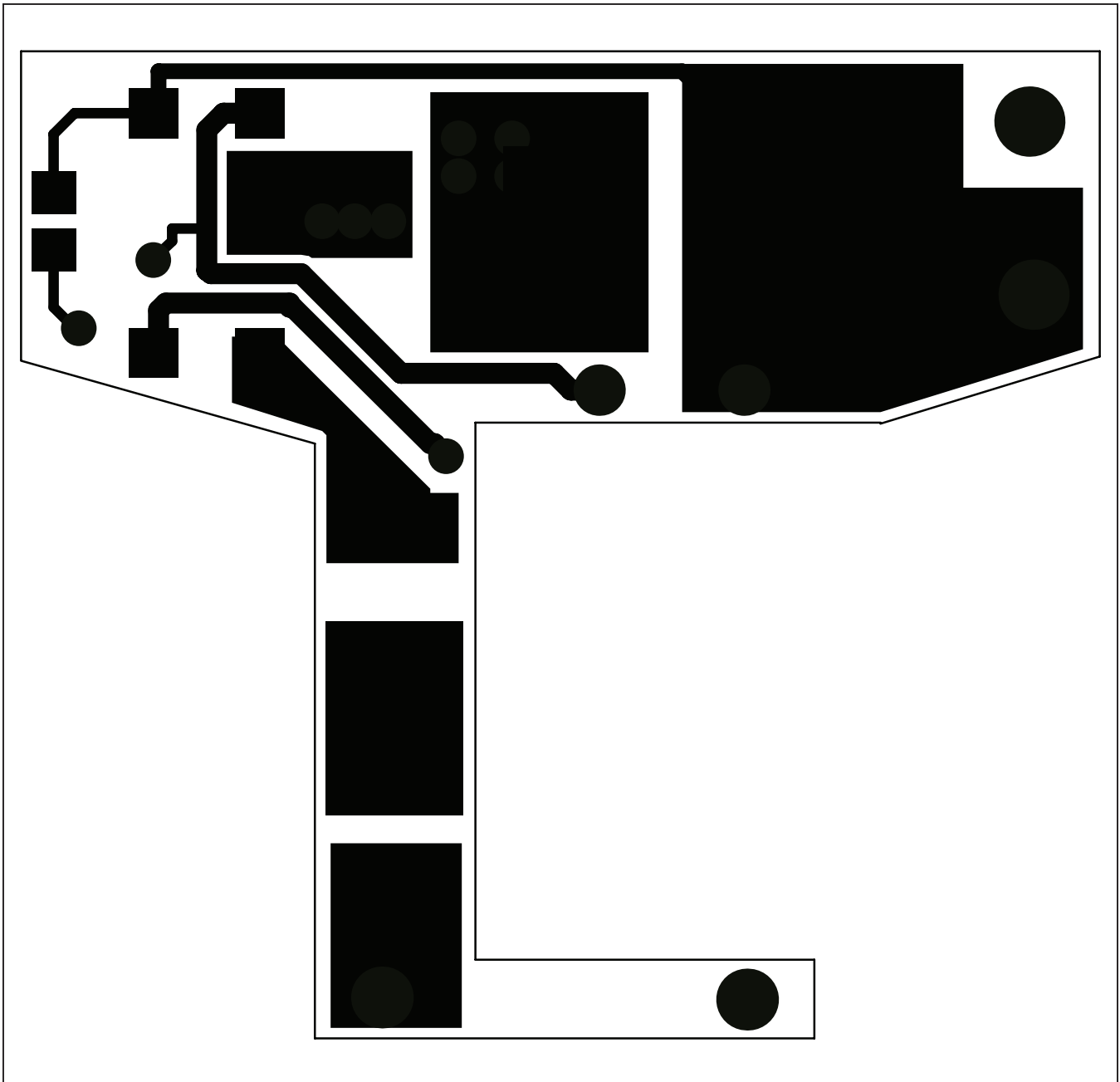

Figure 7. MAX16840L EV Kit PCB Layout—Solder Side

MAX16840L Evaluation Kit

Evaluates: MAX16840

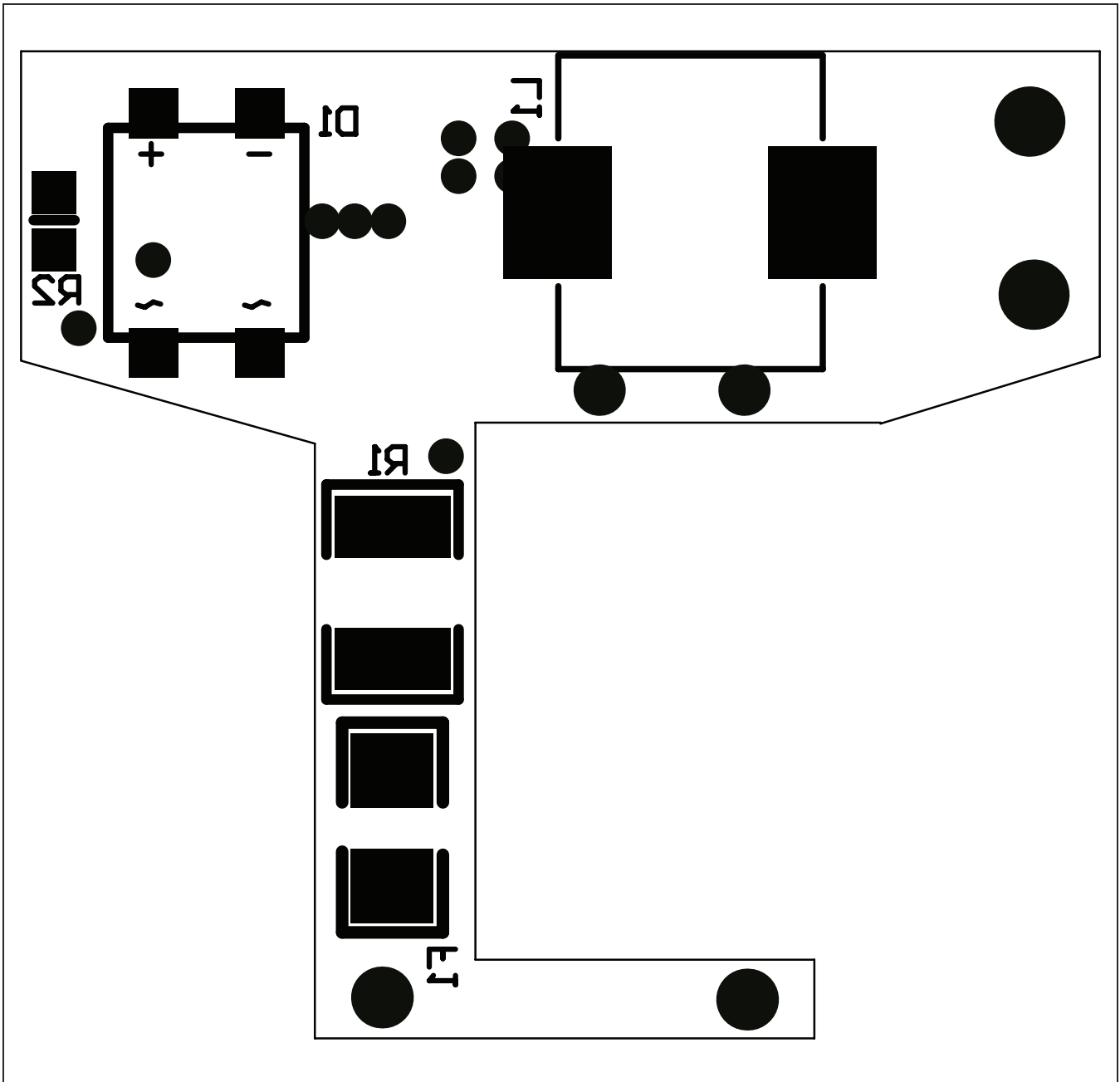

Figure 8. MAX16840L EV Kit Component Placement Guide—Solder Side

MAX16840L Evaluation Kit

Evaluates: MAX16840

Ordering Information

PART	TYPE
MAX16840LEVKIT#	EV Kit

#Denotes RoHS compliant.

MAX16840L Evaluation Kit

Evaluates: MAX16840

Revision History

REVISION NUMBER	REVISION DATE	DESCRIPTION	PAGES CHANGED
0	7/11	Initial release	—

Maxim cannot assume responsibility for use of any circuitry other than circuitry entirely embodied in a Maxim product. No circuit patent licenses are implied. Maxim reserves the right to change the circuitry and specifications without notice at any time.

Maxim Integrated Products, 120 San Gabriel Drive, Sunnyvale, CA 94086 408-737-7600 _____ 12