

6通道、高速逻辑电平转换器

概述

MAX13030E-MAX13035E是6通道、双向电平转换器，能够为多电压系统中的100Mbps数据传输提供电平转换功能。MAX13030E-MAX13035E可理想用于6通道系统的存储卡电平转换以及通用电平转换。外接电源电压 V_{CC} 和 V_L ，分别设置器件两侧的逻辑电平。器件 V_L 侧的逻辑信号在 V_{CC} 侧转换为高压逻辑信号，反之亦然。MAX13035E具有CLK_RET输出功能，返回加载至CLK_VL输入的时钟信号。

MAX13030E-MAX13035E能够在外部驱动器源出电流低至4mA时工作在全速模式。每个I/O通道通过内部30 μ A电流源上拉至 V_{CC} 或 V_L ，允许MAX13030E-MAX13035E采用推挽或漏极开路驱动器来驱动。

MAX13030E-MAX13034E具有使能(EN)输入，该引脚为逻辑低电平时，器件进入低功耗关断模式。MAX13030E-MAX13035E具有自动关断模式，一旦 V_{CC} 低于 V_L 则禁止器件工作。关断期间， V_{CC} 侧I/O和 V_L 侧I/O的状态有具体的器件版本确定(见订购信息/选型指南)。

MAX13030E-MAX13035E的 V_{CC} 范围为+2.2V至+3.6V； V_L 的电压范围为+1.62V至+3.2V，适用于低电压ASIC/PLD与高压系统之间的数据传输。MAX13030E-MAX13035E采用16焊球UCSP (2mm x 2mm)或16引脚TQFN (4mm x 4mm)封装，工作在-40°C至+85°C扩展级温度范围。

应用

SD卡电平转换
MiniSD卡电平转换
MMC电平转换
Transflash卡电平转换
记忆棒电平转换

特性

- ◆ 能够配合4mA或更大的输入驱动器工作
- ◆ 保证100Mbps的数据速率
- ◆ 6路双向通道
- ◆ 时钟返回输出(MAX13035E)
- ◆ 使能输入(MAX13030E-MAX13034E)
- ◆ V_{CC} 侧I/O具有 ± 15 kV ESD保护
- ◆ 电源电压范围： $+1.62\text{V} \leq V_L \leq +3.2\text{V}$ ； $+2.2\text{V} \leq V_{CC} \leq +3.6\text{V}$
- ◆ 16焊球UCSP (2mm x 2mm)或16引脚TQFN (4mm x 4mm)无铅封装

典型工作电路

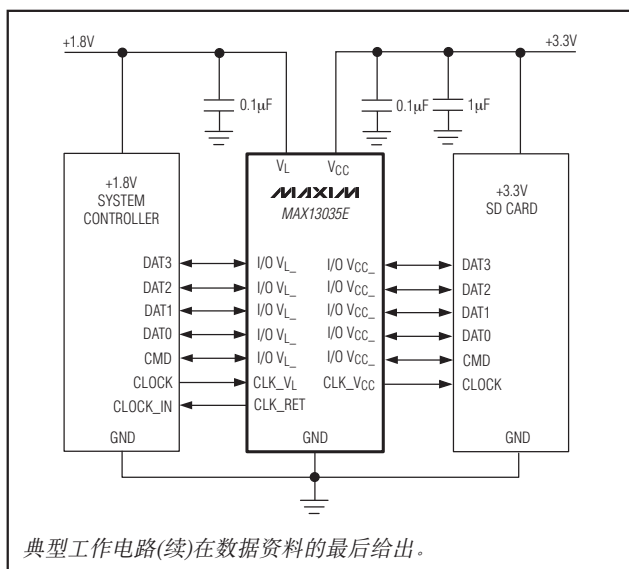

典型工作电路(续)在数据资料的最后给出。

功能框图和引脚配置在数据资料的最后给出。

订购信息/选型指南

PART	PIN-PACKAGE	I/O V_L STATE DURING SHUTDOWN	I/O V_{CC} STATE DURING SHUTDOWN	PKG CODE
MAX13030EEBE+	16 UCSP	High impedance	High impedance	B16-1
MAX13030EETE+	16 TQFN-EP**	High impedance	High impedance	T1644-4

注：所有器件工作于-40°C至+85°C温度范围。

+表示无铅封装。

**EP = 裸焊盘。

订购信息/选型指南(续)在数据资料的最后给出。

6通道、高速逻辑电平转换器

MAX13030E-MAX13035E

ABSOLUTE MAXIMUM RATINGS

(All voltages referenced to GND.)

V _{CC} , V _L	-0.3V to +4V
I/O V _{CC_} , CLK_V _{CC}	-0.3V to (V _{CC} + 0.3V)
I/O V _L , CLK_V _L , CLK_RET	-0.3V to (V _L + 0.3V)
EN	-0.3V to +4V
Short-Circuit Duration I/O V _L , I/O V _{CC_} , CLK_V _{CC} , CLK_V _L , CLK_RET to GND	Continuous
Continuous Power Dissipation (T _A = +70°C)	
16-Bump UCSP (derate 8.2mW/°C)	660mW
16-Pin TQFN (derate 25.0mW/°C)	2000mW

Operating Temperature Range	-40°C to +85°C
Storage Temperature Range	-65°C to +150°C
Junction Temperature	+150°C
Bump Temperature (soldering)	+235°C
Lead Temperature (soldering, 10s)	+300°C

Stresses beyond those listed under "Absolute Maximum Ratings" may cause permanent damage to the device. These are stress ratings only, and functional operation of the device at these or any other conditions beyond those indicated in the operational sections of the specifications is not implied. Exposure to absolute maximum rating conditions for extended periods may affect device reliability.

ELECTRICAL CHARACTERISTICS

(V_{CC} = +2.2V to +3.6V, V_L = +1.62V to +3.2V, EN = V_L, T_A = -40°C to +85°C, unless otherwise noted. Typical values are at V_{CC} = +3.3V, V_L = +1.8V and T_A = +25°C.) (Notes 1, 2)

PARAMETER	SYMBOL	CONDITIONS	MIN	TYP	MAX	UNITS
POWER SUPPLIES						
V _L Supply Range	V _L	(Note 2)	1.62		3.20	V
V _{CC} Supply Range	V _{CC}		2.2		3.6	V
Supply Current from V _{CC}	I _{QVCC}	I/O V _{CC_} = V _{CC} , I/O V _L = V _L		16	25	μA
Supply Current from V _L	I _{QVL}	I/O V _{CC_} = V _{CC} , I/O V _L = V _L		6	10	μA
V _{CC} Shutdown Supply Current	ISHDN-VCC	T _A = +25°C, EN = GND or V _L > V _{CC} + 0.7V, MAX13030E-MAX13034E		2	4	μA
		T _A = +25°C, V _L > V _{CC} + 0.7V, MAX13035E,		2	4	
V _L Shutdown Supply Current	ISHDN-VL	T _A = +25°C, EN = GND or V _L > V _{CC} + 0.7V, MAX13030E-MAX13034E		0.1	4	μA
		T _A = +25°C, V _L > V _{CC} + 0.7V, MAX13035E		0.1	4	
I/O V _{CC_} , I/O V _L , CLK_V _{CC} Tri-State Leakage Current	I _{LEAK}	T _A = +25°C, EN = GND or V _L > V _{CC} + 0.7V		0.1	2	μA
EN Input Leakage Current	I _{LEAK_EN}	T _A = +25°C, MAX13030E-MAX13034E			1	μA
V _L - V _{CC} Shutdown Threshold High	V _{TH_H}	V _{CC} rising	-0.2	0.05V _L	0.7	V
V _L - V _{CC} Shutdown Threshold Low	V _{TH_L}	V _{CC} falling	-0.2	0.1V _L	0.7	V
I/O V _{CC_} Pulldown Resistance During Shutdown	R _{VCC_PD_SD}	EN = GND, MAX13032E/MAX13034E	10	16.5	23	kΩ
I/O V _{CC_} Pullup Resistance During Shutdown	R _{VCC_PU_SD}	EN = GND, MAX13031E	10	16.5	23	kΩ
I/O V _L Pulldown Resistance During Shutdown	R _{VL_PD_SD}	EN = GND, MAX13033E/MAX13034E	10	16.5	23	kΩ

6通道、高速逻辑电平转换器

MAX13030E-MAX13035E

ELECTRICAL CHARACTERISTICS (continued)

($V_{CC} = +2.2V$ to $+3.6V$, $V_L = +1.62V$ to $+3.2V$, $EN = V_L$, $T_A = -40^{\circ}C$ to $+85^{\circ}C$, unless otherwise noted. Typical values are at $V_{CC} = +3.3V$, $V_L = 1.8V$ and $T_A = +25^{\circ}C$.) (Notes 1, 2)

PARAMETER	SYMBOL	CONDITIONS	MIN	TYP	MAX	UNITS
I/O V_L , CLK_ V_L , CLK_RET Pullup Resistance During Shutdown	$R_{VL_PU_SD}$	($V_L > V_{CC} + 0.7V$), MAX13035E	45	75	105	$k\Omega$
I/O V_L , CLK_ V_L , CLK_RET Pullup Current	R_{VL_PU}	$EN = V_{CC}$ or V_L , I/O $V_L = GND$	20			μA
I/O $V_{CC_}$, CLK_ V_{CC} Pullup Current	R_{VCC_PU}	$EN = V_{CC}$ or V_L , I/O $V_{CC_} = GND$	20			μA
I/O V_L to I/O V_{CC} DC Resistance	R_{IOVL_IOVCC}	(Note 3)		3		$k\Omega$
ESD PROTECTION (Note 3)						
I/O $V_{CC_}$, CLK_ V_{CC}		Human Body Model, $C_{VCC} = 1.0\mu F$		± 15		kV
		IEC 61000-4-2 Air-Gap Discharge, $C_{VCC} = 1.0\mu F$		± 12		
		IEC 61000-4-2 Contact Discharge, $C_{VCC} = 1.0\mu F$		± 8		
LOGIC-LEVEL THRESHOLDS						
I/O V_L , CLK_ V_L Input-Voltage High Threshold	V_{IHL}	(Note 4)			$V_L - 0.2$	V
I/O V_L , CLK_ V_L Input-Voltage Low Threshold	V_{ILL}	(Note 4)	0.15			V
I/O $V_{CC_}$, CLK_ V_{CC} Input-Voltage High Threshold	V_{IHC}	(Note 4)			$V_{CC} - 0.4$	V
I/O $V_{CC_}$, CLK_ V_{CC} Input-Voltage Low Threshold	V_{ILC}	(Note 4)	0.2			V
EN Input-Voltage High Threshold	V_{IH}	MAX13030E-MAX13034E			$V_L - 0.4$	V
EN Input-Voltage Low	V_{IL}	MAX13030E-MAX13034E	0.4			V
I/O V_L , CLK_ V_L , CLK_RET Output-Voltage High	V_{OHL}	I/O V_L , CLK_ V_L , CLK_RET source current = $20\mu A$, I/O $V_{CC_} \geq V_{CC} - 0.4V$	$2/3 V_L$			V
I/O V_L , CLK_ V_L , CLK_RET Output-Voltage Low	V_{OLL}	I/O V_L , CLK_ V_L , CLK_RET sink current = $20\mu A$, I/O $V_{CC_} \leq 0.2V$			$1/3 V_L$	V
I/O $V_{CC_}$, CLK_ V_{CC} Output-Voltage High	V_{OHC}	I/O $V_{CC_}$, CLK_ V_{CC} source current = $20\mu A$, I/O $V_L \geq V_L - 0.2V$	$2/3 V_{CC}$			V

6通道、高速逻辑电平转换器

MAX13030E-MAX13035E

ELECTRICAL CHARACTERISTICS (continued)

($V_{CC} = +2.2V$ to $+3.6V$, $V_L = +1.62V$ to $+3.2V$, $EN = V_L$, $T_A = -40^{\circ}C$ to $+85^{\circ}C$, unless otherwise noted. Typical values are at $V_{CC} = +3.3V$, $V_L = 1.8V$ and $T_A = +25^{\circ}C$.) (Notes 1, 2)

PARAMETER	SYMBOL	CONDITIONS	MIN	TYP	MAX	UNITS
I/O $V_{CC_}$, CLK_ V_{CC} Output-Voltage Low	V_{OLC}	I/O $V_{CC_}$, CLK_ V_{CC} sink current = $20\mu A$, I/O $V_L \leq 0.15V$			$1/3 V_{CC}$	V
RISE/FALL TIME ACCELERATOR STAGE (Note 3)						
Accelerator Pulse Duration		On falling edge		3		ns
		On rising edge		3		
V_L -Output-Accelerator Source Impedance		$V_L = 1.62V$		11		Ω
		$V_L = 3.2V$		6		
V_{CC} -Output-Accelerator Source Impedance		$V_{CC} = 2.2V$		9		Ω
		$V_{CC} = 3.6V$		8		
V_L -Output-Accelerator Sink Impedance		$V_L = 1.62V$		9		Ω
		$V_L = 3.2V$		8		
V_{CC} -Output-Accelerator Sink Impedance		$V_{CC} = 2.2V$		10		Ω
		$V_{CC} = 3.6V$		9		

TIMING CHARACTERISTICS

($V_{CC} = +2.2V$ to $+3.6V$, $V_L = +1.62V$ to $+3.2V$, $C_{I/OVL} \leq 15pF$, $C_{I/OVCC} \leq 15pF$, $R_{SOURCE} = 150\Omega$, $EN = V_L$, I/O V_L to I/O V_{CC} rise/fall time = $3ns$, $T_A = -40^{\circ}C$ to $+85^{\circ}C$, unless otherwise noted. Typical values are at $V_{CC} = +3.3V$, $V_L = 1.8V$ and $T_A = +25^{\circ}C$.) (Note 1)

PARAMETER	SYMBOL	CONDITIONS	MIN	TYP	MAX	UNITS
I/O $V_{CC_}$, CLK_ V_{CC} Rise Time	t_{RVCC}	$R_S = 150\Omega$, $C_{I/OVCC} = 10pF$, $C_{CLK_VCC} = 10pF$, push-pull drivers (Figure 1)			2.5	ns
I/O $V_{CC_}$, CLK_ V_{CC} Fall Time	t_{FVCC}	$R_S = 150\Omega$, $C_{I/OVCC} = 10pF$, $C_{CLK_VCC} = 10pF$ (Figures 1, 2)			2.5	ns
I/O V_L , CLK_ V_L Rise Time	t_{RVL}	$R_S = 150\Omega$, $C_{I/OVL} = 15pF$, $C_{CLK_VL} = 15pF$, push-pull drivers (Figure 3)			2.5	ns
I/O V_L , CLK_ V_L Fall Time	t_{FVL}	$R_S = 150\Omega$, $C_{I/OVL} = 15pF$, $C_{CLK_VL} = 15pF$ (Figures 3, 4)			2.5	ns
Propagation Delay (Driving I/O V_L , CLK_ V_L)	$t_{PVL-VCC}$	$R_S = 150\Omega$, $C_{I/OVCC} = 10pF$, $C_{CLK_VCC} = 10pF$, push-pull drivers (Figure 1)			6.5	ns
Propagation Delay (Driving I/O $V_{CC_}$, CLK_ V_{CC})	$t_{PVCC-VL}$	$R_S = 150\Omega$, $C_{I/OVL} = 15pF$, $C_{CLK_VL} = 15pF$, push-pull drivers (Figure 3)			6.5	ns
Channel-to-Channel Skew	t_{SKEW}	$R_S = 150\Omega$, $C_{I/OVCC} = 10pF$, $C_{I/OVL} = 15pF$			0.8	ns
Propagation Delay from I/O V_L to I/O $V_{CC_}$ after EN	t_{EN-VCC}	$R_{LOAD} = 1M\Omega$, $C_{I/OVCC} = 10pF$ (Figure 5) (MAX13030E-MAX13034E)		5		μs

6通道、高速逻辑电平转换器

MAX13030E-MAX13035E

TIMING CHARACTERISTICS (continued)

($V_{CC} = +2.2V$ to $+3.6V$, $V_L = +1.62V$ to $+3.2V$, $C_{I/OVL} \leq 15pF$, $C_{I/OVCC} \leq 15pF$, $R_{SOURCE} = 150\Omega$, $EN = V_L$, I/O $V_{L_}$ to I/O $V_{CC_}$ rise/fall time = 3ns, $T_A = -40^\circ C$ to $+85^\circ C$, unless otherwise noted. Typical values are at $V_{CC} = +3.3V$, $V_L = 1.8V$ and $T_A = +25^\circ C$.) (Note 1)

PARAMETER	SYMBOL	CONDITIONS	MIN	TYP	MAX	UNITS
Propagation Delay from I/O $V_{CC_}$ to I/O $V_{L_}$ after EN	t_{EN-VL}	$R_{LOAD} = 1M\Omega$, $C_{I/OVL} = 15pF$ (Figure 5) (MAX13030E-MAX13034E)		5		μs
Maximum Data Rate		Push-pull operation, $R_{SOURCE} = 150\Omega$, $C_{I/OVCC_} = 10pF$, $C_{I/OVL_} = 15pF$, $C_{CLK_VCC} = 10pF$, $C_{CLK_VL} = 15pF$	100			Mbps

Note 1: All units are 100% production tested at $T_A = +25^\circ C$. Limits over the operating temperature range are guaranteed by design and not production tested.

Note 2: V_L must be less than or equal to $V_{CC} - 0.2V$ during normal operation. However, V_L can be greater than V_{CC} during startup and shutdown conditions and the part will not latch-up or be damaged.

Note 3: Guaranteed by design.

Note 4: Input thresholds are referenced to the boost circuit.

6通道、高速逻辑电平转换器

典型工作特性

($V_{CC} = 3.3V$, $V_L = 1.8V$, $C_L = 15pF$, $R_{SOURCE} = 150\Omega$, data rate = 100Mbps, push-pull driver, $T_A = +25^\circ C$, unless otherwise noted.)

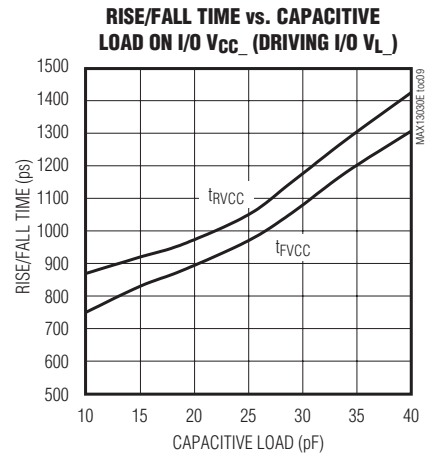
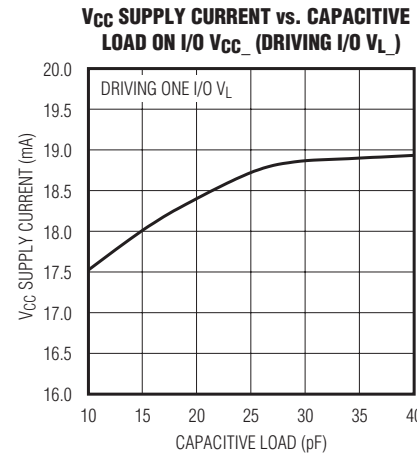
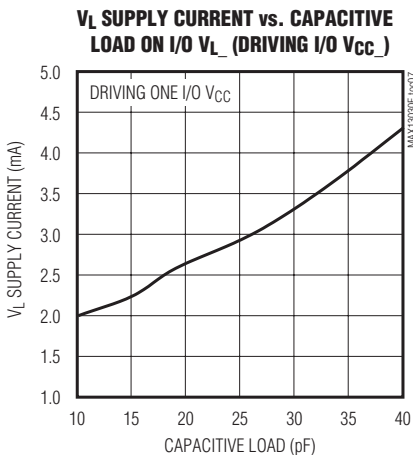
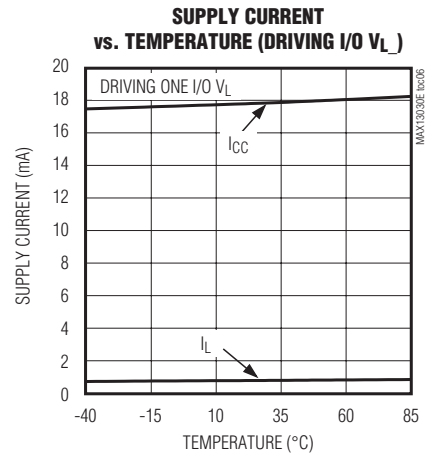
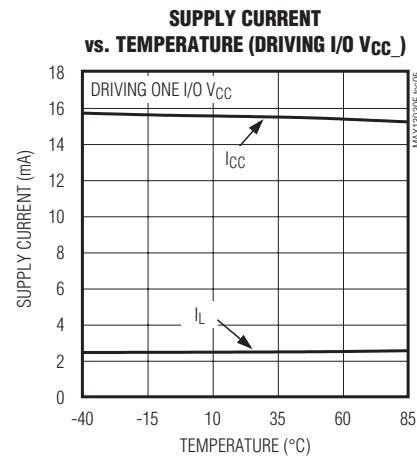
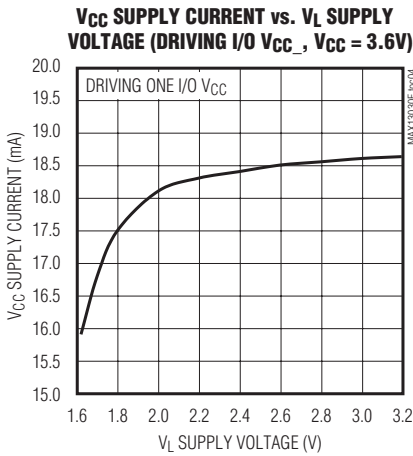
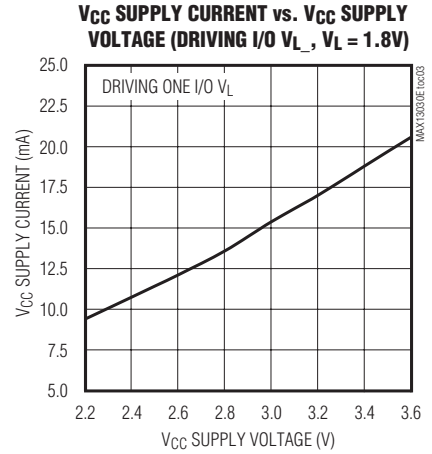
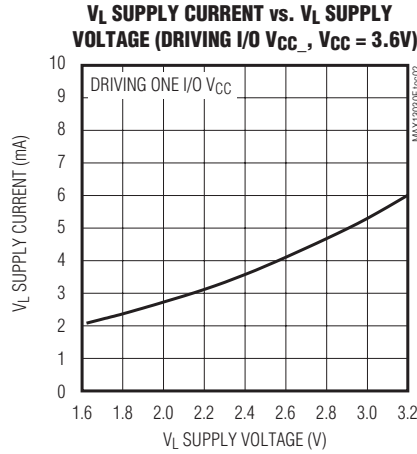
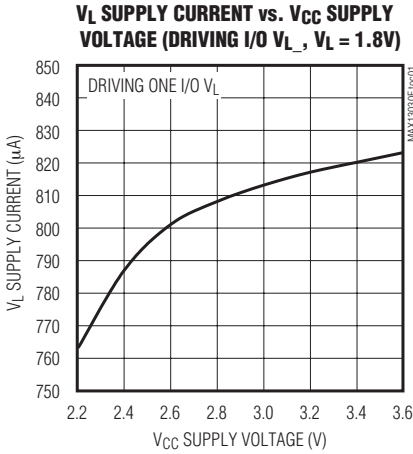

6通道、高速逻辑电平转换器

MAX13030E-MAX13035E

典型工作特性(续)

($V_{CC} = 3.3V$, $V_L = 1.8V$, $C_L = 15pF$, $R_{SOURCE} = 150\Omega$, data rate = 100Mbps, push-pull driver, $T_A = +25^\circ C$, unless otherwise noted.)

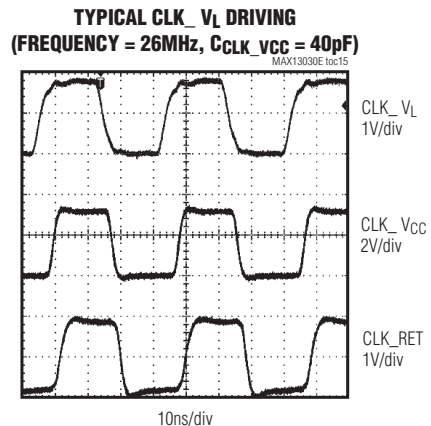
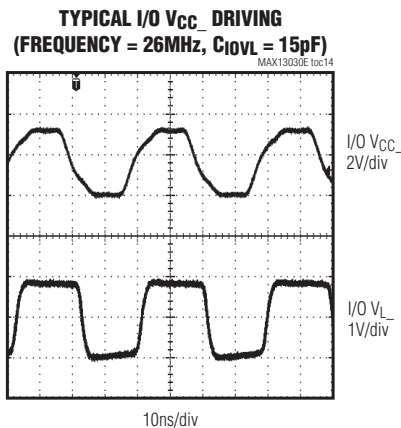
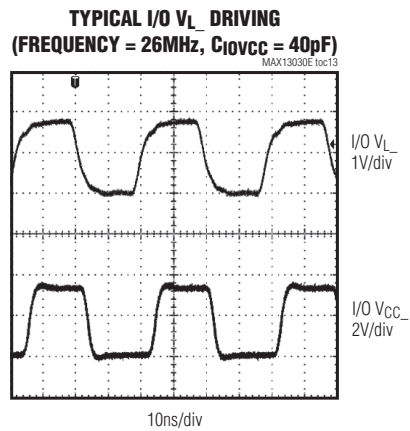
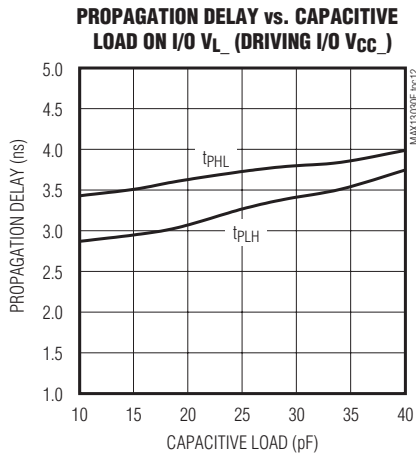
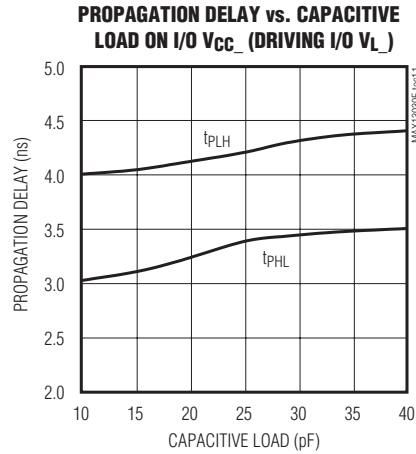
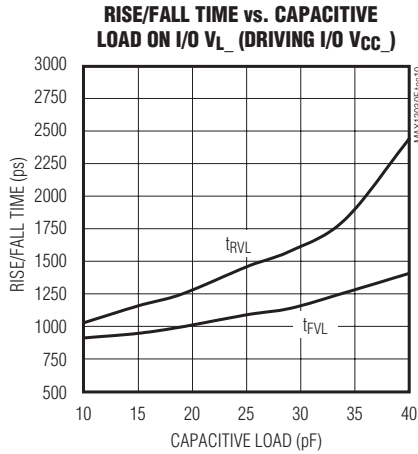

6通道、高速逻辑电平转换器

引脚说明

MAX13030E-MAX13035E

引脚				名称	功能
MAX13030E-MAX13034E		MAX13035E			
UCSP	TQFN	UCSP	TQFN		
A1	4	A1	4	I/O V _L 3	输入/输出3, 以V _L 为参考。
A2	6	A2	6	I/O V _{CC} 3	输入/输出3, 以V _{CC} 为参考。
A3	7	A3	7	I/O V _{CC} 4	输入/输出4, 以V _{CC} 为参考。
A4	9	A4	9	I/O V _L 4	输入/输出4, 以V _L 为参考。
B1	3	B1	3	I/O V _L 2	输入/输出2, 以V _L 为参考。
B2	5	B2	5	I/O V _{CC} 2	输入/输出2, 以V _{CC} 为参考。
B3	8	B3	8	I/O V _{CC} 5	输入/输出5, 以V _{CC} 为参考。
B4	10	B4	10	I/O V _L 5	输入/输出5, 以V _L 为参考。
C1	2	C1	2	V _L	逻辑供电电压, 电压范围: +1.62V至+3.2V。采用一只0.1μF电容旁路V _L 至GND, 并尽可能靠近器件放置。
C2	16	C2	16	V _{CC}	电源电压, 电压范围: +2.2V至+3.6V。为了提供有效的ESD保护, 采用一只0.1μF电容旁路V _{CC} 至GND, 并尽可能靠近V _{CC} 放置。
C3	13	C3	13	GND	地。
C4	11	—	—	EN	使能输入, 驱动EN至GND时进入关断模式; 驱动EN至V _{CC} 或V _L 时, 正常工作。
D1	1	D1	1	I/O V _L 1	输入/输出1, 以V _L 为参考。
D2	15	D2	15	I/O V _{CC} 1	输入/输出1, 以V _{CC} 为参考。
D3	14	—	—	I/O V _{CC} 6	输入/输出6, 以V _{CC} 为参考。
D4	12	—	—	I/O V _L 6	输入/输出6, 以V _L 为参考。
—	—	C4	11	CLK_RET	时钟返回输出, CLK_RET可返回CLK_V _L 输入端的时钟信号, CLK_RET以V _L 为参考。
—	—	D3	14	CLK_V _{CC}	时钟电平转换通道, 用于V _{CC} 侧时钟。
—	—	D4	12	CLK_V _L	时钟电平转换通道, 用于V _L 侧时钟。
—	EP	—	EP	EP	裸焊盘, 连接裸焊盘至GND。

6通道、高速逻辑电平转换器

测试电路/时序图

MAX13030E-MAX13035E



图1. 推挽驱动 V_L 侧 I/O 的测试电路和时序



图2. 漏极开路驱动 V_L 侧 I/O 的测试电路和时序

6通道、高速逻辑电平转换器

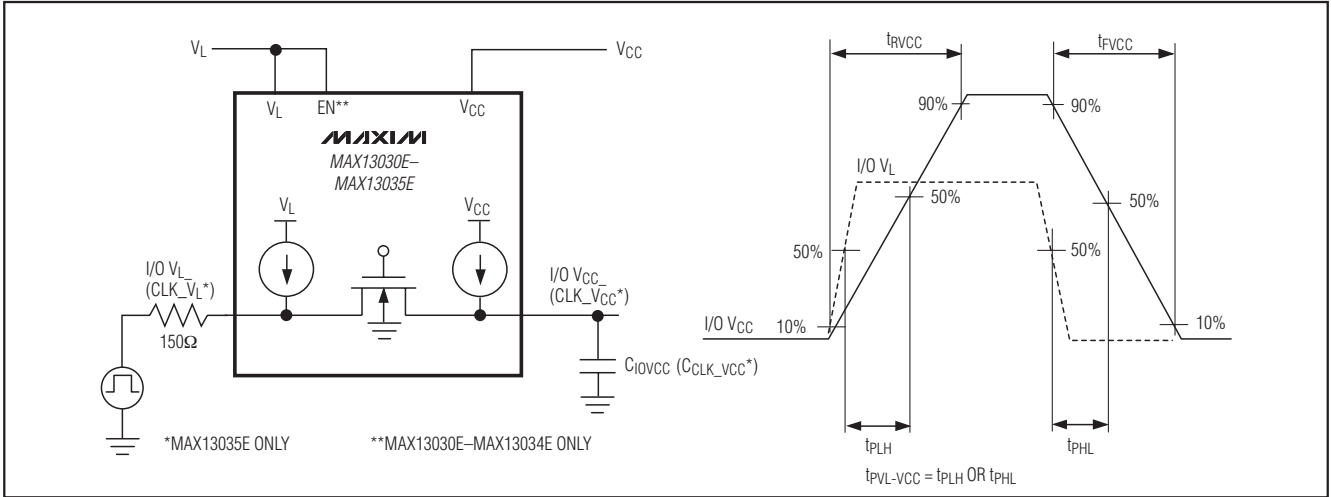
测试电路/时序图(续)

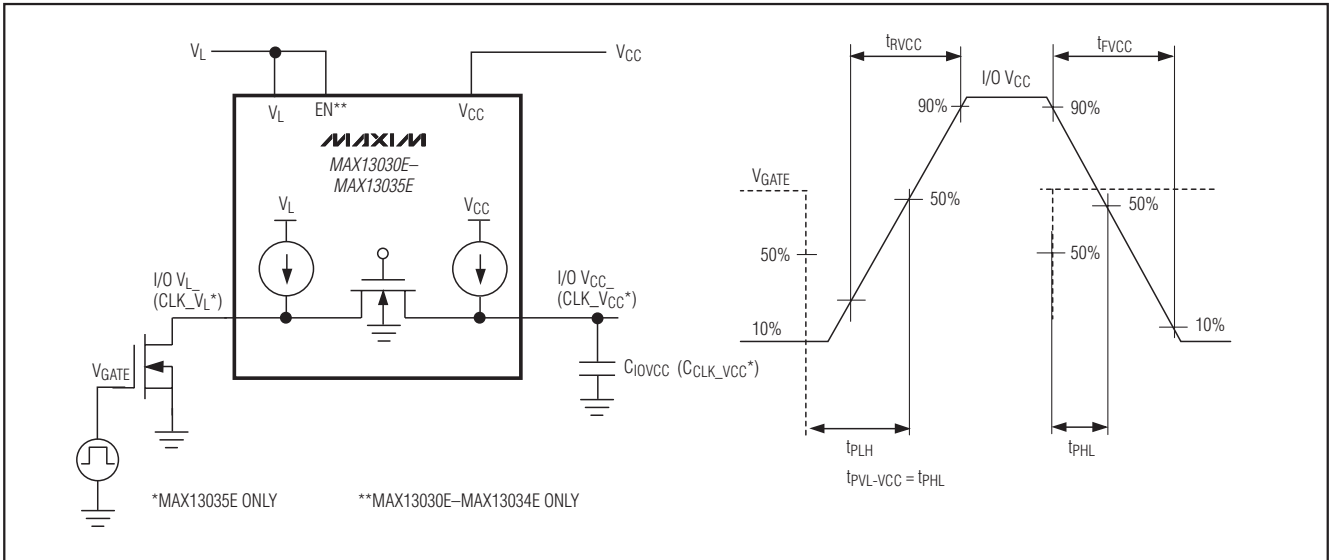

图3. 推挽驱动V_{CC}侧I/O的测试电路和时序



图4. 漏极开路驱动V_{CC}侧I/O的测试电路和时序

6通道、高速逻辑电平转换器

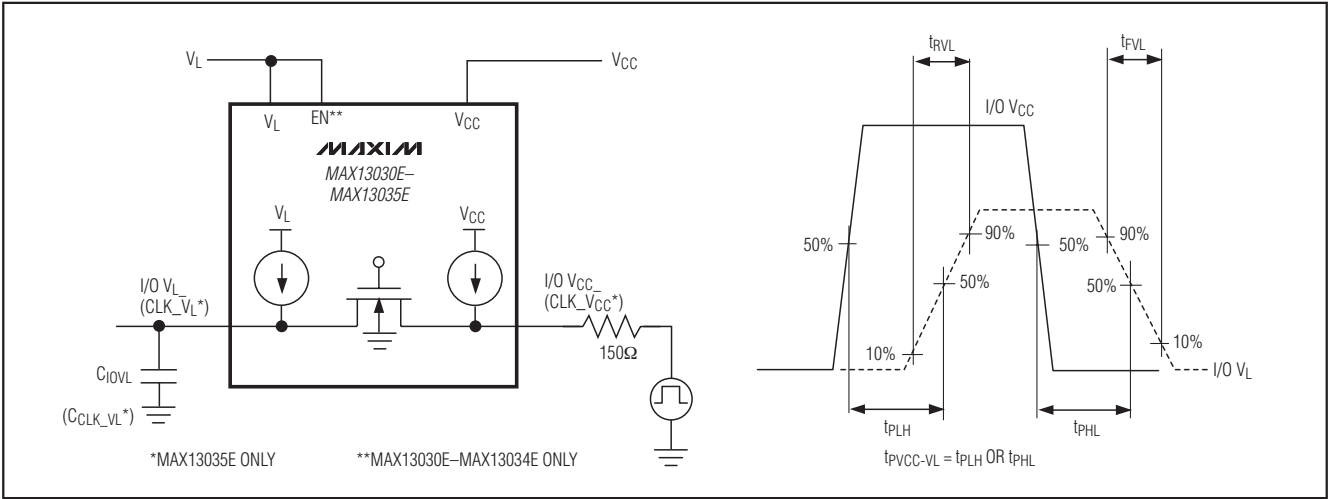
测试电路/时序图(续)

MAX13030E-MAX13035E

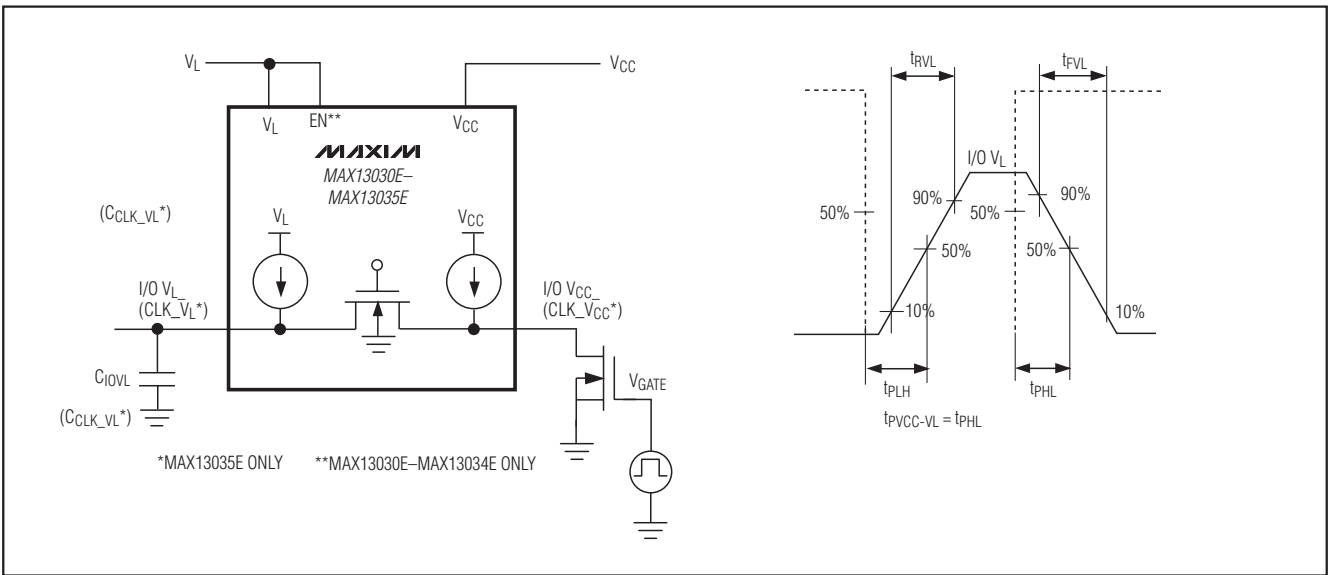

图5. 使能测试电路及时序

6通道、高速逻辑电平转换器

详细说明

MAX13030E-MAX13035E是6通道、双向电平转换器，能够在多电压系统中为100Mbps数据传输提供电平转换。MAX13030E-MAX13035E可理想用于6通道系统的存储卡电平转换以及通用电平转换。外部电源电压 V_{CC} 和 V_L 分别设置器件两侧的逻辑电平。器件 V_L 侧的逻辑信号在器件的 V_{CC} 侧转换成高压逻辑信号，反之亦然。MAX13035E具有CLK_RET输出功能，可返回加载至CLK_ V_L 输入的时钟信号。

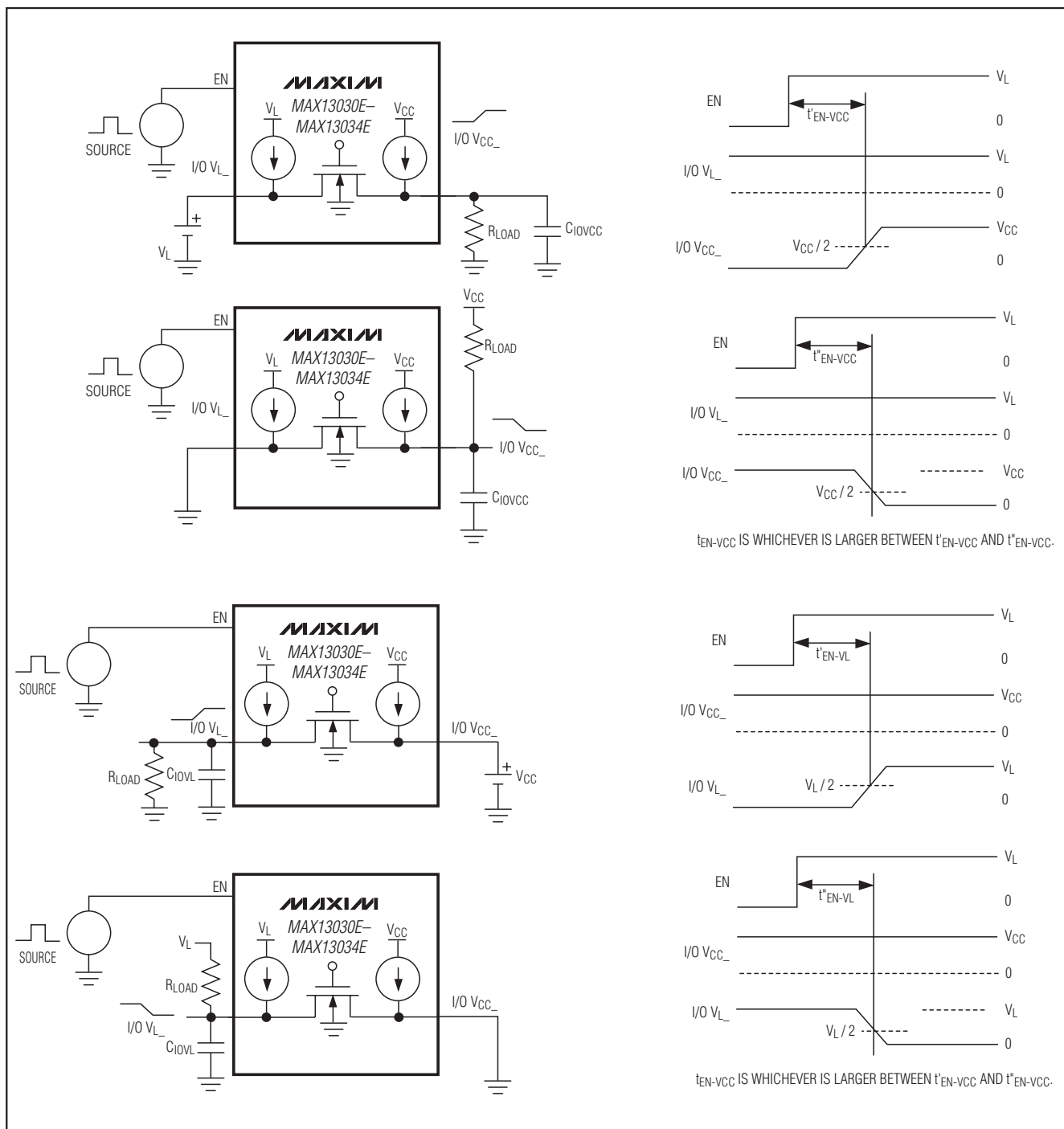
MAX13030E-MAX13035E能够在外部驱动器源出电流低至4mA时工作在全速模式。每个I/O通道可通过内部30 μ A电流源上拉至 V_{CC} 或 V_L ，允许MAX13030E-MAX13035E采用推挽或漏极开路驱动器来驱动。

MAX13030E-MAX13034E具有使能(EN)输入，该引脚为逻辑低电平时器件进入低功耗关断模式。MAX13030E-MAX13035E具有自动关断模式，一旦 V_{CC} 低于 V_L 则禁止器件工作。关断期间， V_{CC} 侧I/O和 V_L 侧I/O的状态由具体的器件版本确定(见[订购信息/选型指南](#)部分)。

MAX13030E-MAX13035E的 V_{CC} 电压范围为+2.2V至+3.6V； V_L 的电压范围为+1.62V至+3.2V。

电平转换

为使芯片正常工作，需确保 $+2.2V \leq V_{CC} \leq +3.6V$ 和 $+1.62V \leq V_L \leq V_{CC} - 0.2V$ 。当 V_L 已上电、 V_{CC} 没有上电或低于 V_L 时，MAX13030E-MAX13035E自动进入低功耗关断模式。另外，EN = 0V时，MAX13030E-MAX13034E进入低功耗关断模式，允许断开 V_{CC} 并且保持 V_L 侧I/O为确定状态。MAX13030E-MAX13035E的最大数据速率在很大程度上取决于负载电容(详见[典型工作特性](#)中的Rise/Fall Times曲线)、驱动器输出阻抗和工作电压范围。

输入驱动器要求

MAX13030E-MAX13035E内部结构基于nMOS门电路和加速输出级(见图6)。加速输出级通常处于三态模式，除非转换器输入端 V_L 侧I/O、CLK_ V_L 、 V_{CC} 侧I/O或CLK_ V_{CC} 出现瞬变。加速输出级启动后将产生一个短脉冲，对I/O口电容进行充/放电。考虑到其双向电平转换特性，在单稳态脉冲期间两个输入级均有效。这会导致一些电流馈入驱动转换器的外部信号源。然而，这一效应更加速了驱动端的瞬变过程。



图6. 一个I/O通道的简化功能框图

MAX13030E-MAX13035E内部30 μ A电流源上拉I/O，这些上拉电流源允许输入采用漏极开路驱动器驱动，不推荐在I/O口使用外部上拉电阻。MAX13030E-MAX13035E的内部结构允许接口两侧采用最小4mA的驱动器驱动。

输出负载要求

MAX13030E-MAX13035E的I/O口设计为驱动CMOS输入，不要在I/O口加载低于25k Ω 的电阻负载。同时，不要将RC电路放置在该系列器件的输入端，以免降低边沿速度。如需较低的数据速率，请参考MAX3000E/MAX3001E逻辑电平转换器数据资料；如需I²C电平转换器，请参考MAX3372E-MAX3379E/MAX3390E-MAX3393E数据资料。

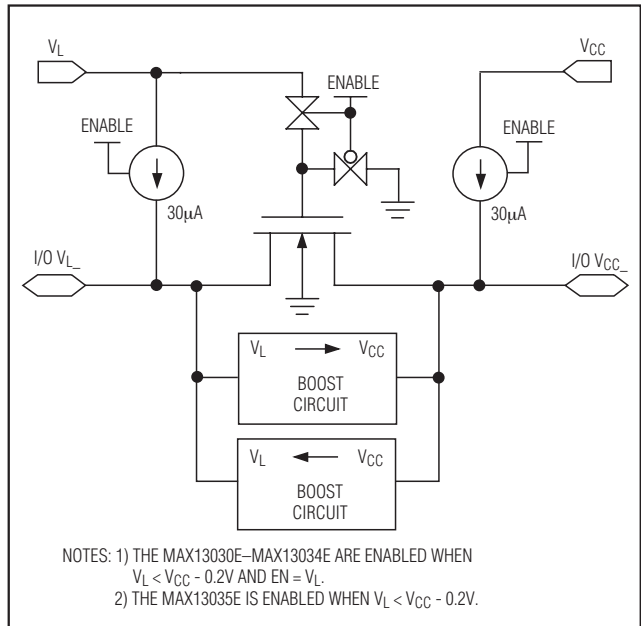
关断模式

MAX13030E-MAX13034E带有使能(EN)输入端。EN置低时，器件进入低功耗关断模式。MAX13030E-MAX13035E具有自动关断模式，当 V_{CC} 掉电或小于 V_L 时，禁止器件工作。

6通道、高速逻辑电平转换器

时钟返回(CLK_RET)

MAX13035E具有CLK_RET输出功能，返回CLK_V_L输入端的时钟信号。CLK_V_L、CLK_V_{CC}和其它通道一样，唯一的区别在于CLK_V_{CC}已在内部连接至V_{CC}侧的CLK_RET (参见功能框图)。

应用信息

推荐布局

MAX13030E-MAX13035E的电路板布局需遵循标准高速信号的布局要求，例如，为降低传输线耦合，所有不与MAX13030E-MAX13035E连接的信号线需要放置在距离MAX13030E-MAX13035E输入和输出端至少1倍于PCB底层高度的地方。

电源去耦

为减小纹波，降低数据出错的概率，采用0.1 μ F的陶瓷电容将V_L和V_{CC}旁路至地。所有电容应尽可能靠近电源引脚放置，为确保有效的 ± 15 kV ESD保护，需采用一只1 μ F电容旁路V_{CC}至地，并将该电容尽可能靠近V_{CC}输入放置。

单向与双向电平转换

MAX13030E-MAX13035E双向电平转换器也可以工作在单向电平转换(无反向转换)，这些器件为单向电平转换提供尺寸最小的解决方案(UCSP封装)。

使用外部上拉/下拉电阻

从MAX13030E-MAX13035E的结构来看，不推荐在总线上使用外部上拉电阻或下拉电阻。在某些特定场合，总线上没有有效的驱动器时，需要通过外部上拉电阻或下拉电阻确定总线状态。例如，在连接到未插存储卡的卡槽时可能出现这种情况。MAX13030E-MAX13035E的内部上拉电流源能够在器件使能时设置总线状态。关断模式下，V_{CC}侧I/O和V_L侧I/O的状态由具体的器件版本决定(详细信息请参考数据资料中的*订购信息/选型指南*部分)。

漏极开路驱动

MAX13030E-MAX13035E专为漏极开路驱动和CMOS推挽驱动而设计，采用漏极开路驱动时，上升时间受内部上拉电流源和寄生负载电容的影响。MAX13030E-MAX13035E内置上升时间加速电路，用于加快瞬态速率，无需外部上拉电阻。

SD卡检测

检测SD、MiniSD、MMC及其它类似的存储卡可通过两种方法实现：在一条DAT线上接上拉电阻或机械开关。存储卡本身内置上拉电阻，MAX13030E-MAX13035E仅能利用机械开关检测存储卡。建议通过命令接口将存储卡检测电阻断开，例如，采用SD卡时，命令SET_CLR_CARD_DETECT (ACMD42)将断开内置电阻。

UCSP应用信息

关于最新的UCSP结构、尺寸、卷带包装信息、PCB技术、焊球焊盘布局和推荐的回流焊温度范围，以及最新的可靠性测试数据，请参考相关的应用笔记：*UCSP—晶片级封装* www.maxim-ic.com.cn/ucsp。

芯片信息

Process: BiCMOS

6通道、高速逻辑电平转换器

功能框图

MAX13030E-MAX13035E

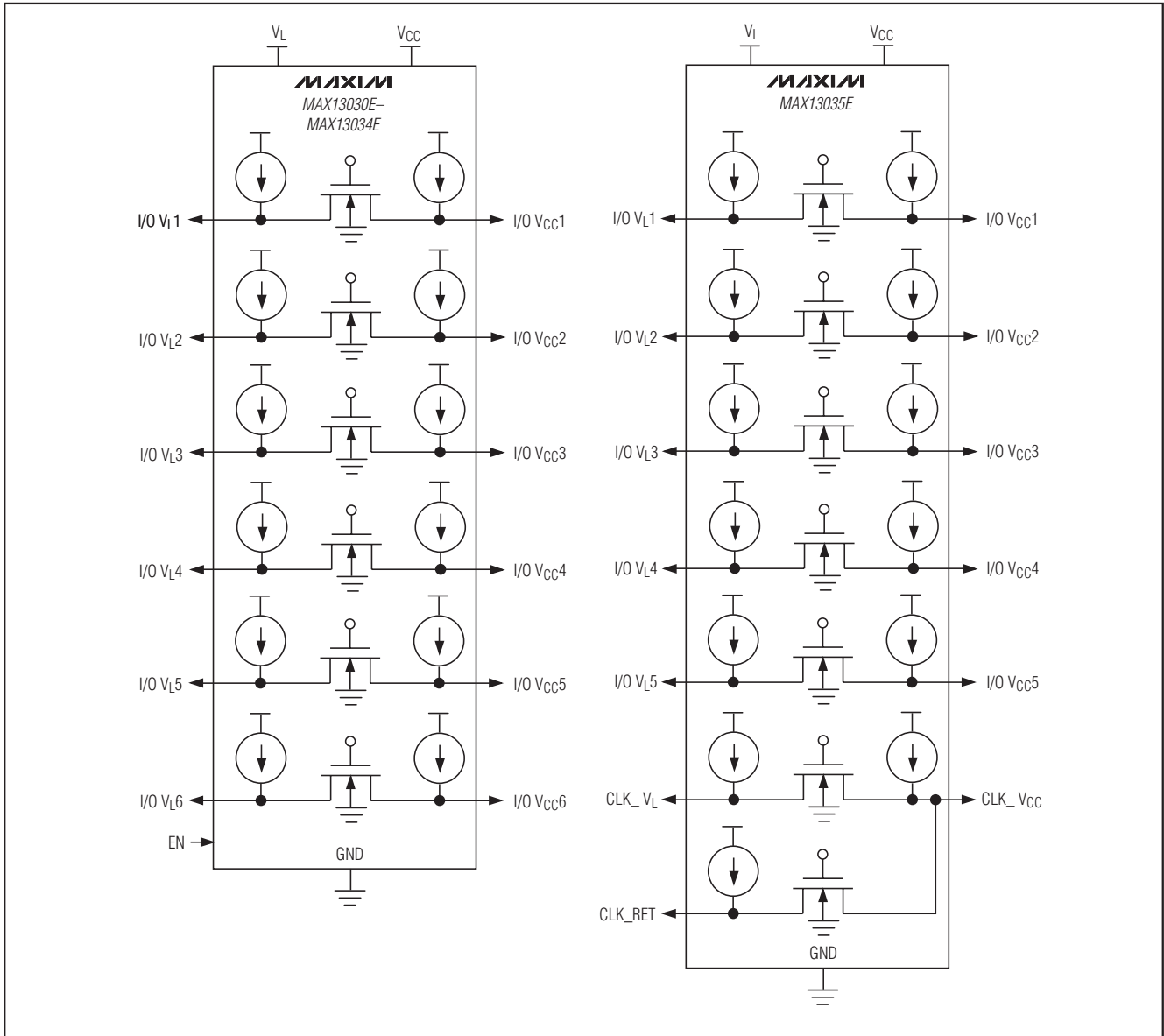

6通道、高速逻辑电平转换器

引脚配置

MAX13030E-MAX13035E

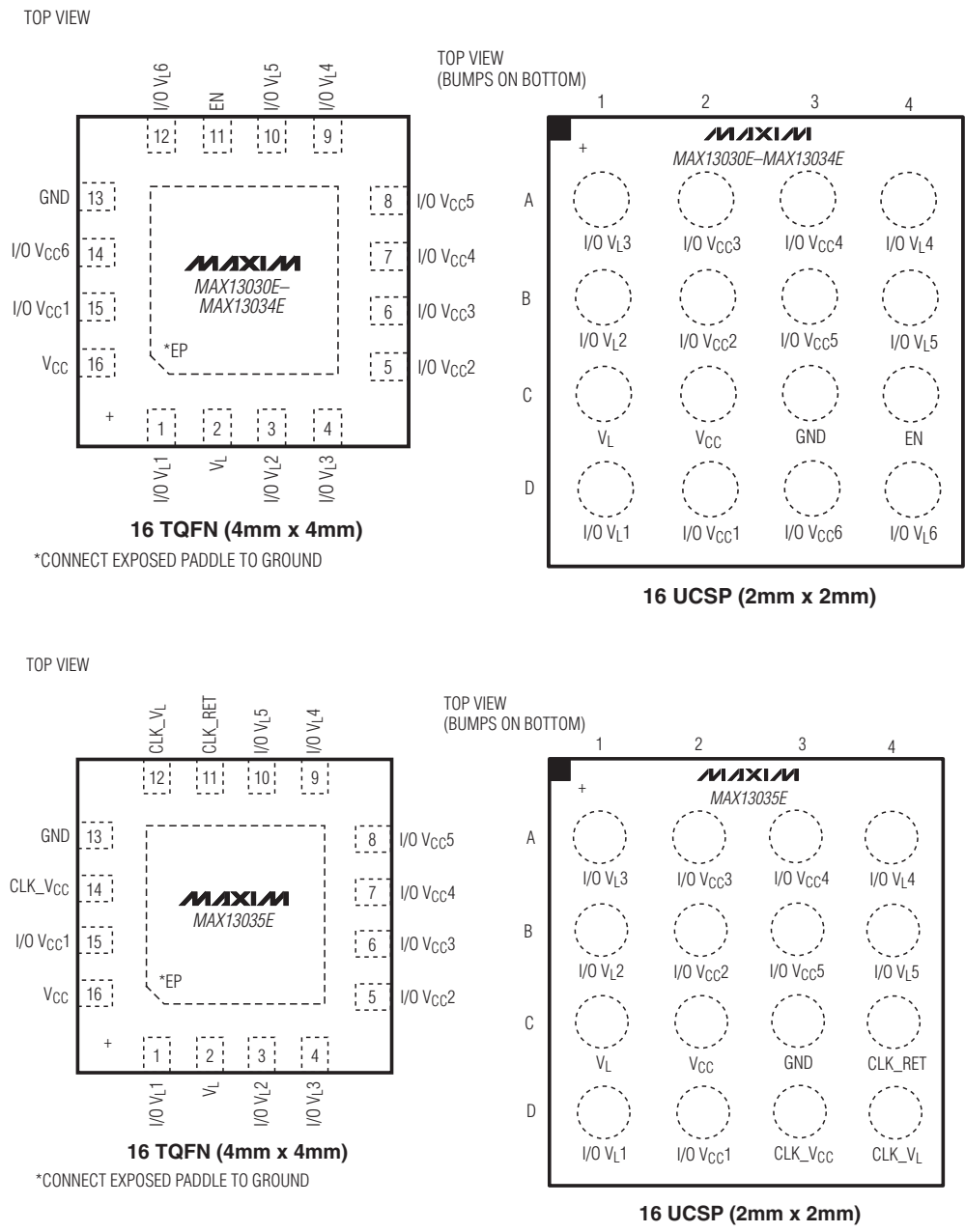

6通道、高速逻辑电平转换器

典型工作电路(续)

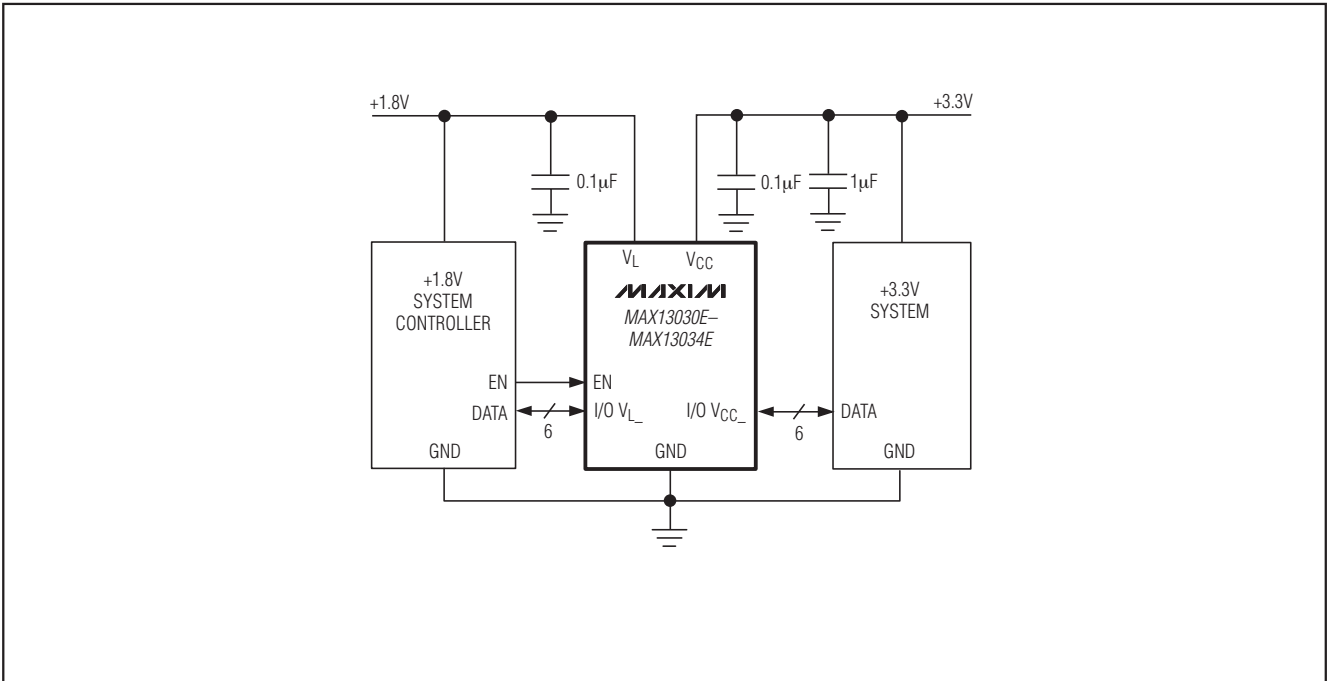

订购信息/选型指南(续)

PART	PIN-PACKAGE	I/O V _L _ STATE DURING SHUTDOWN	I/O V _{CC} _ STATE DURING SHUTDOWN	PKG CODE
MAX13031E EBE+*	16 UCSP	High impedance	16.5kΩ to V _{CC}	B16-1
MAX13031EETE+*	16 TQFN-EP**	High impedance	16.5kΩ to V _{CC}	T1644-4
MAX13032E EBE+	16 UCSP	High impedance	16.5kΩ to GND	B16-1
MAX13032EETE+	16 TQFN-EP**	High impedance	16.5kΩ to GND	T1644-4
MAX13033E EBE+*	16 UCSP	16.5kΩ to GND	High impedance	B16-1
MAX13033EETE+*	16 TQFN-EP**	16.5kΩ to GND	High impedance	T1644-4
MAX13034E EBE+*	16 UCSP	16.5kΩ to GND	16.5kΩ to GND	B16-1
MAX13034EETE+*	16 TQFN-EP**	16.5kΩ to GND	16.5kΩ to GND	T1644-4
MAX13035E EBE+	16 UCSP	75kΩ to V _L	High impedance	B16-1
MAX13035EETE+	16 TQFN-EP**	75kΩ to V _L	High impedance	T1644-4

注：所有器件工作于-40°C至+85°C温度范围。

+表示无铅封装。

**EP = 裸焊盘。

6通道、高速逻辑电平转换器

封装信息

(本数据资料提供的封装图可能不是最近的规格，如需最近的封装外形信息，请查询 www.maxim-ic.com.cn/packages.)

MAX13030E-MAX13035E

TOP VIEW

COMMON DIMENSIONS	
A	0.62±0.05-0.08
A1	0.29±0.02
A2	0.33 REF.
b	0.35±0.03
D1	1.50 BASIC
E1	1.50 BASIC
e	0.50 BASIC
SD	0.25 BASIC
SE	0.25 BASIC

PKG. CODE	VARIABLE DIMENSIONS		DEPOPULATED SOLDER BALLS
	D	E	
B16-1	2.02±0.05	2.02±0.05	NONE
B16-2	2.02±0.05	2.02±0.05	B3, C3
B16-3	2.02±0.05	2.02±0.05	B3, C2
B16-4	2.02±0.05	2.02±0.05	B2, C3
B16-5	2.02±0.05	2.02±0.05	B2, B3, C2, C3
B16-6	2.02±0.05	2.02±0.05	C3

NOTES:

- ALL DIMENSIONS ARE IN MILLIMETERS.
- PRODUCT MARKING: NUMBER OF CHARACTERS AND LINES VARY PER PRODUCT.

BOTTOM VIEW

SIDE VIEW

DALLAS SEMICONDUCTOR		
MAXIM		
PROPRIETARY INFORMATION		
TITLE: PACKAGE OUTLINE, 4x4 UCSP		
APPROVAL	DOCUMENT CONTROL NO. 21-0101	REV. H 1/1

16L UCSP.EPS

6通道、高速逻辑电平转换器

封装信息(续)

(本数据资料提供的封装图可能不是最近的规格, 如需最近的封装外形信息, 请查询 www.maxim-ic.com.cn/packages.)

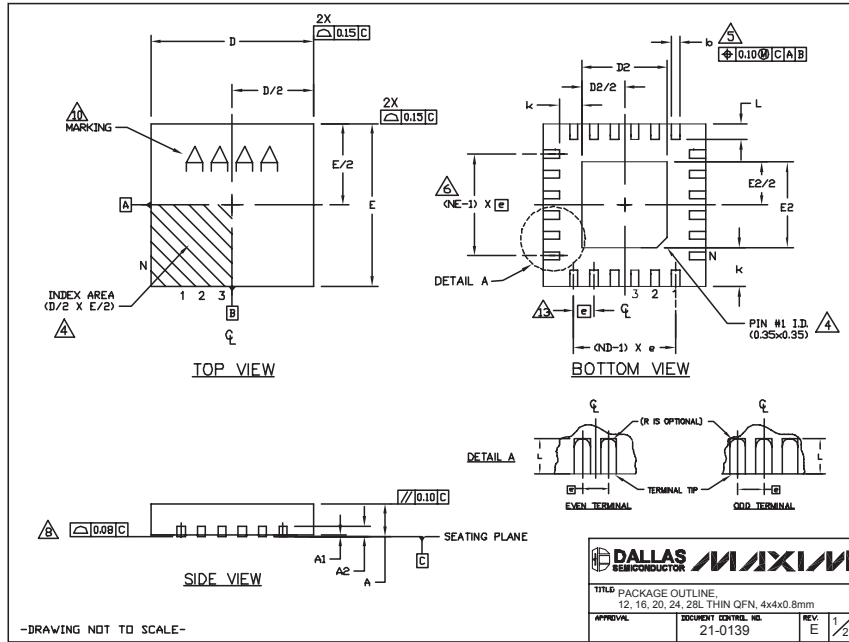

COMMON DIMENSIONS															
PKG REF.	12L 4x4			16L 4x4			20L 4x4			24L 4x4			28L 4x4		
	MIN.	NOM.	MAX.	MIN.	NOM.	MAX.	MIN.	NOM.	MAX.	MIN.	NOM.	MAX.	MIN.	NOM.	MAX.
A	0.70	0.75	0.80	0.70	0.75	0.80	0.70	0.75	0.80	0.70	0.75	0.80	0.70	0.75	0.80
A1	0.0	0.02	0.05	0.0	0.02	0.05	0.0	0.02	0.05	0.0	0.02	0.05	0.0	0.02	0.05
AE	0.20 REF			0.20 REF			0.20 REF			0.20 REF			0.20 REF		
b	0.25	0.30	0.35	0.25	0.30	0.35	0.20	0.25	0.30	0.10	0.23	0.30	0.15	0.20	0.25
D	3.90	4.00	4.10	3.90	4.00	4.10	3.90	4.00	4.10	3.90	4.00	4.10	3.90	4.00	4.10
E	3.90	4.00	4.10	3.90	4.00	4.10	3.90	4.00	4.10	3.90	4.00	4.10	3.90	4.00	4.10
e	0.80 BSC.			0.65 BSC.			0.50 BSC.			0.50 BSC.			0.40 BSC.		
k	0.25	-	-	0.25	-	-	0.25	-	-	0.25	-	-	0.25	-	-
L	0.45	0.55	0.65	0.45	0.55	0.65	0.45	0.55	0.65	0.30	0.40	0.50	0.30	0.40	0.50
N	12	-	-	16	-	-	20	-	-	24	-	-	28	-	-
ND	3	-	-	4	-	-	5	-	-	6	-	-	7	-	-
NE	3	-	-	4	-	-	5	-	-	6	-	-	7	-	-
VG50C	-	-	-	-	-	-	WGDD-1	-	-	WGDD-2	-	-	VGGE	-	-
VG6	-	-	-	VGGB	-	-	VGGC	-	-	WGDD-1	-	-	WGDD-2	-	-

EXPOSED PAD VARIATIONS												
PKG CODES	D2			E2			DOWN BOND ALLOWED					
	MIN.	NOM.	MAX.	MIN.	NOM.	MAX.						
T1244-3	1.95	2.10	2.25	1.95	2.10	2.25	YES					
T1244-4	1.95	2.10	2.25	1.95	2.10	2.25	NO					
T1644-3	1.95	2.10	2.25	1.95	2.10	2.25	YES					
T1644-4	1.95	2.10	2.25	1.95	2.10	2.25	NO					
T2044-2	1.95	2.10	2.25	1.95	2.10	2.25	YES					
T2044-3	1.95	2.10	2.25	1.95	2.10	2.25	NO					
T2444-2	1.95	2.10	2.25	1.95	2.10	2.25	YES					
T2444-3	2.45	2.60	2.63	2.45	2.60	2.63	YES					
T2444-4	2.45	2.60	2.63	2.45	2.60	2.63	NO					
T2844-1	2.30	2.60	2.70	2.30	2.60	2.70	NO					

NOTES:

- DIMENSIONING & TOLERANCING CONFORM TO ASME Y14.5M-1994.
- ALL DIMENSIONS ARE IN MILLIMETERS. ANGLES ARE IN DEGREES.
- N IS THE TOTAL NUMBER OF TERMINALS.

THE TERMINAL #1 IDENTIFIER AND TERMINAL NUMBERING CONVENTION SHALL CONFORM TO JEDEC 95-1 SFP-012. DETAILS OF TERMINAL #1 IDENTIFIER ARE OPTIONAL, BUT MUST BE LOCATED WITHIN THE ZONE INDICATED. THE TERMINAL #1 IDENTIFIER MAY BE EITHER A MOLD OR MARKED FEATURE.

DIMENSION b APPLIES TO METALLIZED TERMINAL AND IS MEASURED BETWEEN 0.25 mm AND 0.30 mm FROM TERMINAL TIP.

ND AND NE REFER TO THE NUMBER OF TERMINALS ON EACH D AND E SIDE RESPECTIVELY.

DEPOPULATION IS POSSIBLE IN A SYMMETRICAL FASHION.

COPLANARITY APPLIES TO THE EXPOSED HEAT SINK SLUG AS WELL AS THE TERMINALS.

DRAWING CONFORMS TO JEDEC M0220, EXCEPT FOR T2444-3, T2444-4 AND T2844-1.

MARKING IS FOR PACKAGE ORIENTATION REFERENCE ONLY.

11. COPLANARITY SHALL NOT EXCEED 0.08mm

12. WARPAGE SHALL NOT EXCEED 0.10mm

LEAD CENTERLINES TO BE AT TRUE POSITION AS DEFINED BY BASIC DIMENSION "a", ±0.05.

14. NUMBER OF LEADS SHOWN ARE FOR REFERENCE ONLY.

DALLAS SEMICONDUCTOR MAXIM

TITLE PACKAGE OUTLINE:
12, 16, 20, 24, 28L THIN QFN, 4x4x0.8mm

APPROVAL DOCUMENT CONTROL NO. 21-0139 REV E 1/2

-DRAWING NOT TO SCALE-

Maxim 不对 Maxim 产品以外的任何电路使用负责, 也不提供其专利许可。Maxim 保留在任何时间、没有任何通报的前提下修改产品资料和规格的权利。

18 Maxim Integrated Products, 120 San Gabriel Drive, Sunnyvale, CA 94086 408-737-7600

© 2007 Maxim Integrated Products

MAXIM 是 Maxim Integrated Products, Inc. 的注册商标。